



Crafttec
surgicals

A photograph of various surgical instruments, including forceps, scissors, and retractors, laid out on a blue sterile drape. A red tray containing sutures is also visible.

**SURGICAL INSTRUMENTS
CATALOGUE**



www.craftecsurgicals.com



+92 333 8721239



info@craftecsurgicals.com



Percussion Hammers & Aesthesiometers



01-101
TROEMNER
Size: 245 mm



01-102
DEJERINE
Size: 200 mm



01-103
DEJERINE
With Needle
Size: 210 mm



01-104
TAYLOR
Size: 195 mm



01-105
BERLINER
Size: 200 mm

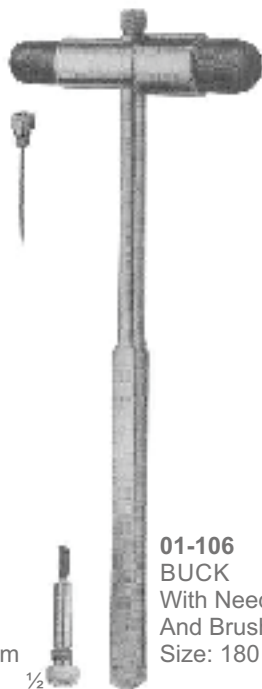

01-106
BUCK
With Needle
And Brush
Size: 180 mm

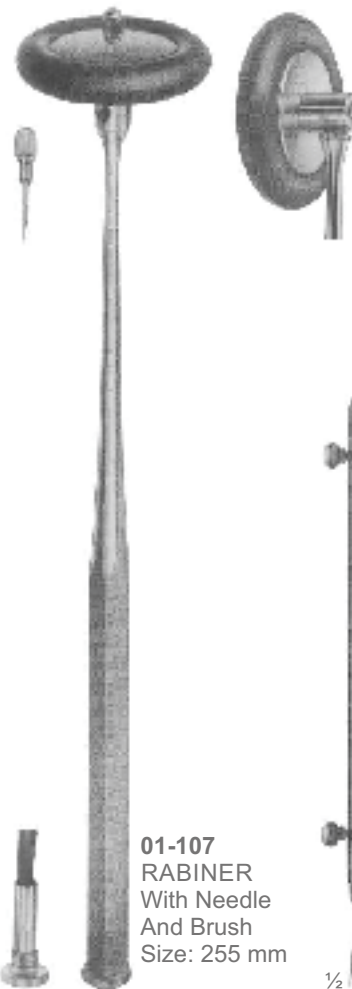

01-107
RABINER
With Needle
And Brush
Size: 255 mm



01-108
ALY
Size: 190 mm



01-109
WARTENBERG
Pinwheel For
Neurological
Examination
Size: 185 mm

Stethoscopes



01-110
PINARD (Aluminum)
Size: 155 mm

1/2



01-111
aus Holz (Wooden)
Size: 145 mm

1/2



01-112
BOWLES
Stethoscope
With Diaphragm

1/4



01-113
ANESTOPHON

1/3



01-114
FORD-BOWLES
Duel Chest Piece
With Two Outlets

1/4



01-115
BOWLES

1/4

Head Mirrors & Head Bands

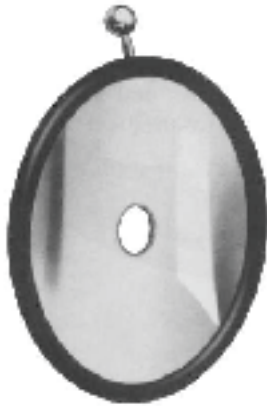

01-116
ZIEGLER \varnothing mm
Head mirror only
with rubber coating

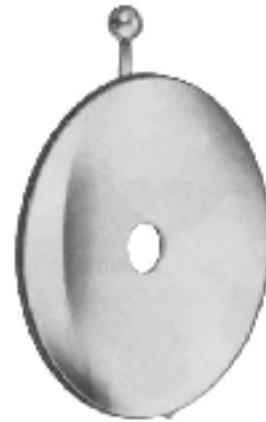

01-117
ZIEGLER \varnothing mm
Head mirror only
with metal coating



01-118
ZIEGLER
Head band of plastic black

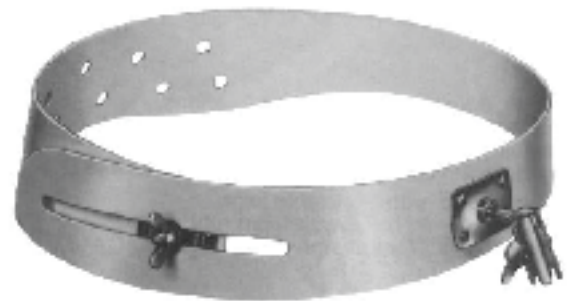

01-120
MURPHY
Head band of celluloid, white

01-119
ZIEGLER
Head band of plastic white

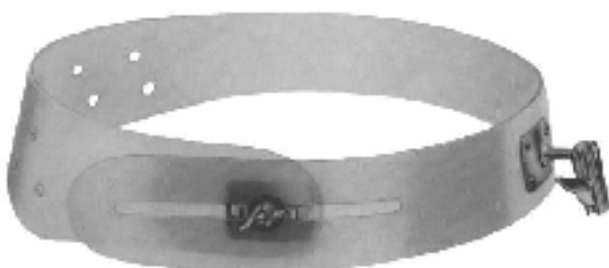

01-121
Head band of plastic,
white, soft pattern



01-122
Head mirror with black
plastic head band.

Head Light

01-123

CLAR

Head light, 6 volt, with adjustable joint, white celluloid head band, cord with plugs for transformer

01-124

White celluloid head band, only, for

01-125

Spare mirror only, for



01-127

CLAR

Head light, 6 volt, with adjustable joint, white celluloid head band, with foam rubber pad and cord with plugs for transformer

01-128

White celluloid head band, only, for head light

01-129

mirror only, for head light

spare foam rubber pad, for head band

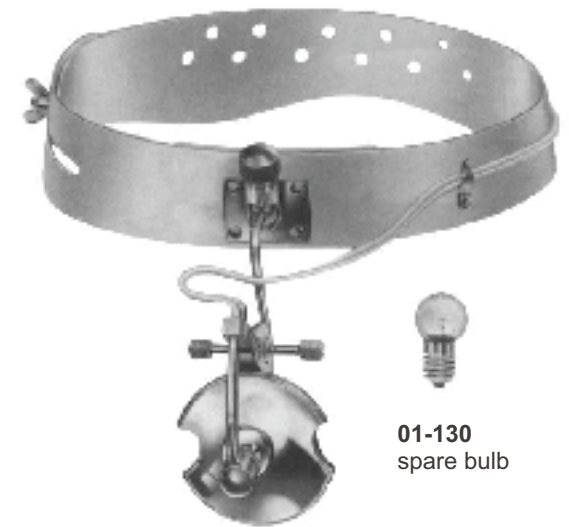

01-131

CLAR

Head light, 6 volt, with adjustable joint, white plastic head band, cord with plugs for transformer



Tongue Depressors

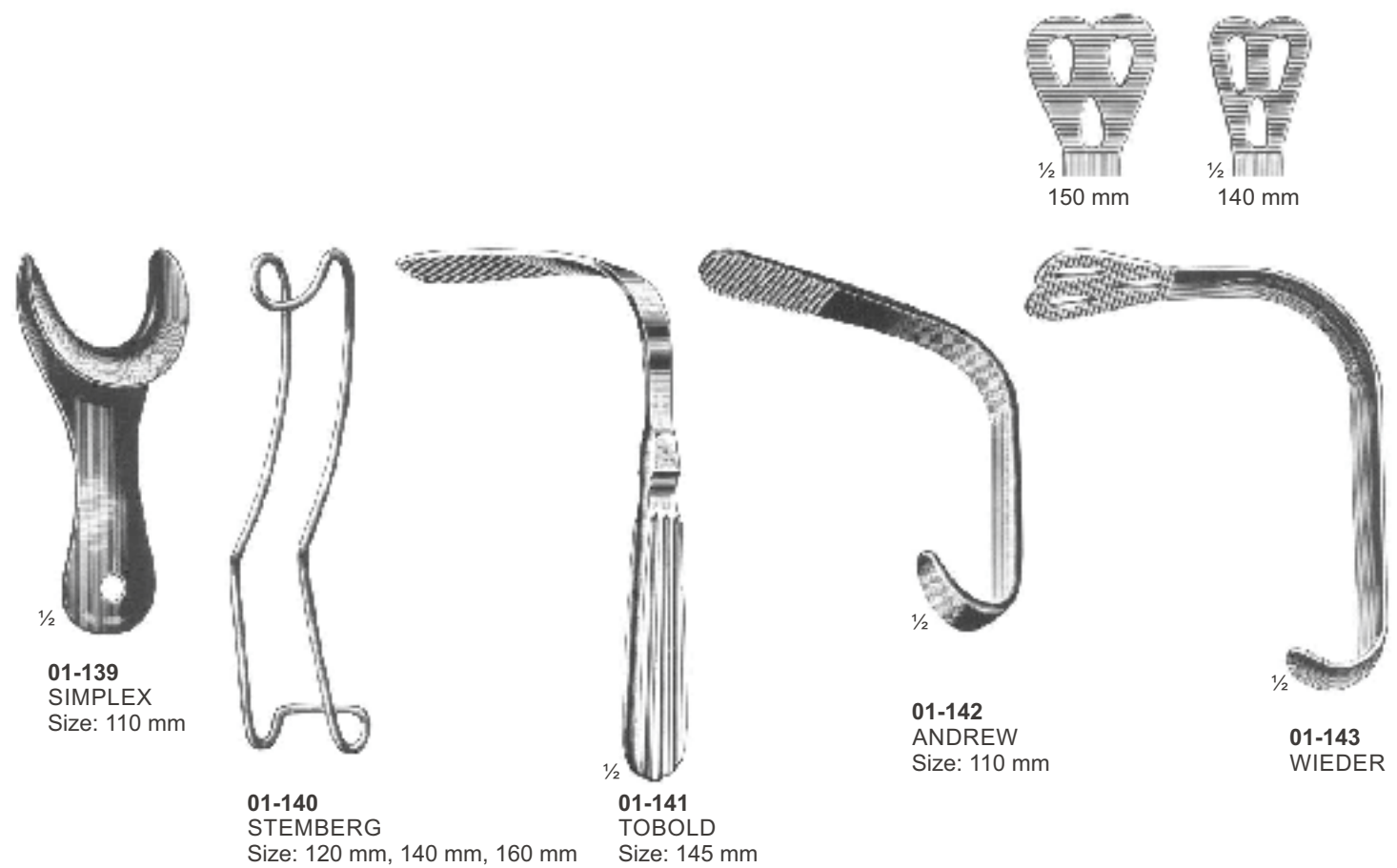
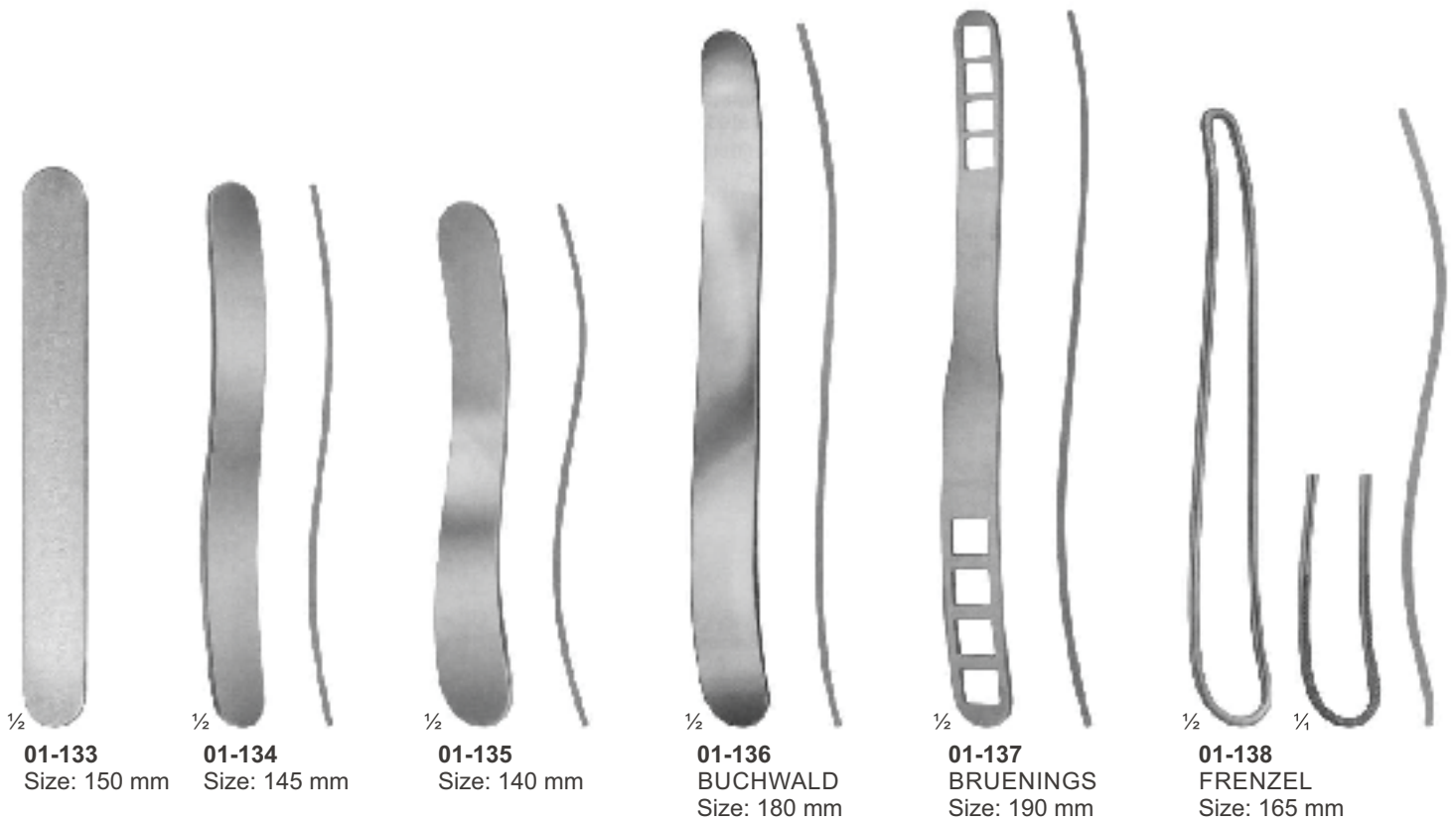

Tongue Depressors



01-144
SCHIMMELBUSCH
Ether Mask



01-145
HEISTER
Mouth Gag
Size: 130 mm



01-146
FERGUSSON-ACKLAND
Mouth Gag
Size: 145 mm



01-147
DENHARDT
Mouth Gag With Silicon
Inserts, Interchangeable
Size: 125 mm



01-148
ROSER KONIG
Mouth Gag
Size: 160 mm, 185 mm

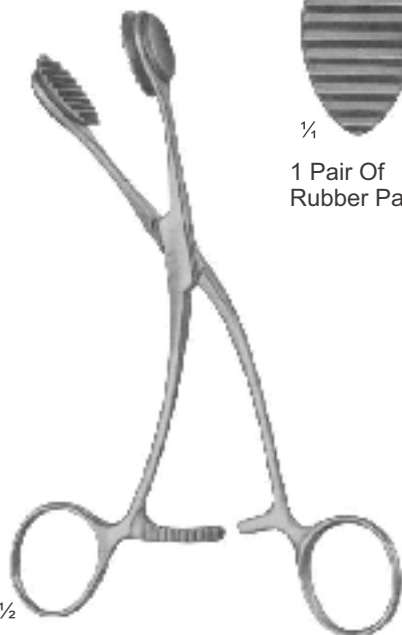

01-149
YOUNG
Size: 165 mm



1 Pair Of
Rubber Pads

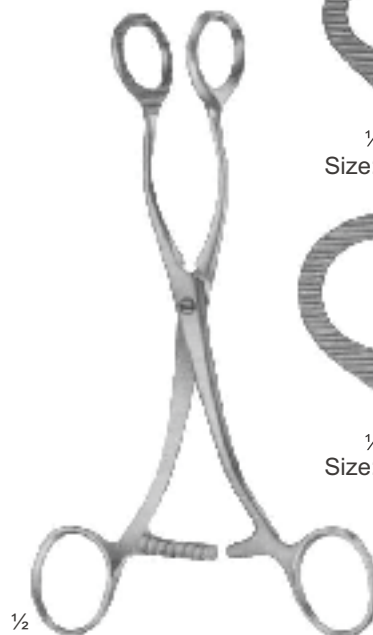

01-150
COLLIN
Size: 160 mm, 170 mm



Size: 160 mm



Size: 170 mm

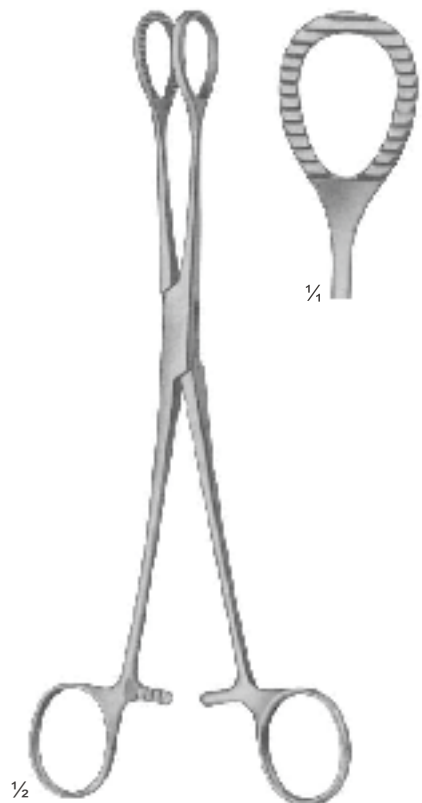

01-151
HEYWOOD-SMITH modif.
Size: 215 mm

Blood Lancets & Laryngeal Mirrors



01-152
FRANCKE
Automatic Blood Lancet



01-153
KOLLE
Microscopic Needle Holder
With Plastic Handle
Size: 240 mm

Fig. 000

Fig. 00

Fig. 0

Fig. 1

Fig. 2

Fig. 3

Fig. 4

Fig. 5

Fig. 6

Fig. 7

Fig. 8

Fig. 9

Fig. 10



01-154
Laryngeal Mirrors With
Hexagonal Handle
Size: 180 mm



01-155
Mirror Handle
Size: 110 mm



01-156
Mirror Handle
Size: 105 mm



01-157
MICHEL
Rhinoscopic Mirrors With
Interchangeable Mirror Inserts



01-158
Spare Mirrors Only
Size: 12 mm



01-159
Spare Mirrors Only
Size: 14 mm

Diagnostic Sets

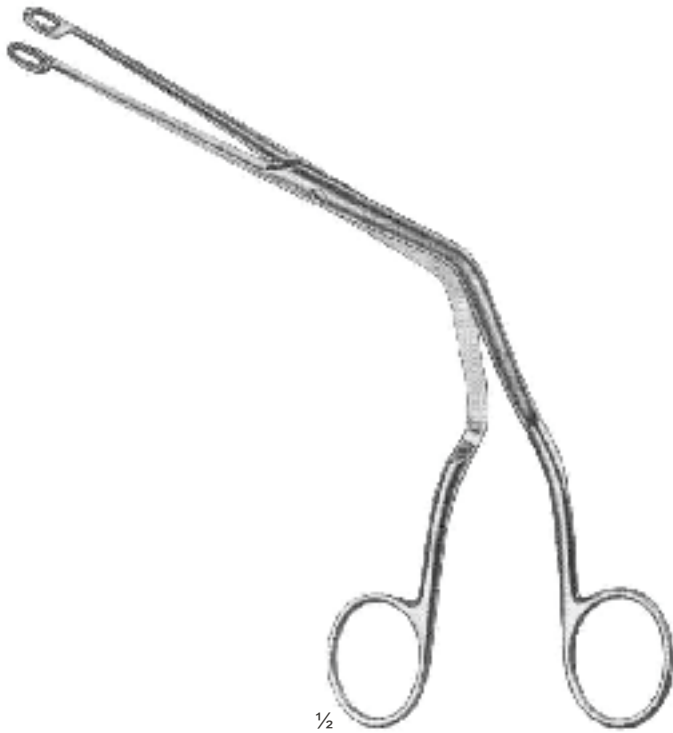

1/2

01-160 - 162
MAGILL



1/4

01-160
Infants
Size: 150 mm



1/4

01-161
Children
Size: 200 mm



1/4

01-162
Adults
Size: 250 mm



1/2

01-163
Medium battery handle
only, 25 mm diam.



01-163-A
Spare bulb
2.7 volt, for
otoscopes



01-163-B
Spare bulb
2.6 volt, for
ophthalmoscopes



01-164
Otoscope Set, Consists Of
Battery Handle Without Batteries,
3 Ear Specula, 1 Bulb In Velvet Lined Case

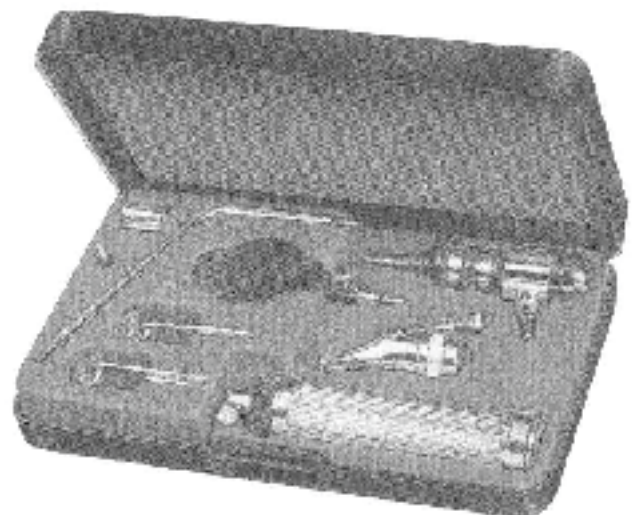

01-165
Diagnostic Set, Otoscope With Three Specula,
Nasal Speculum, Lamp Holder, Two Laryngeal
Mirrors, Tongue Blade Holder

Diagnostic Sets

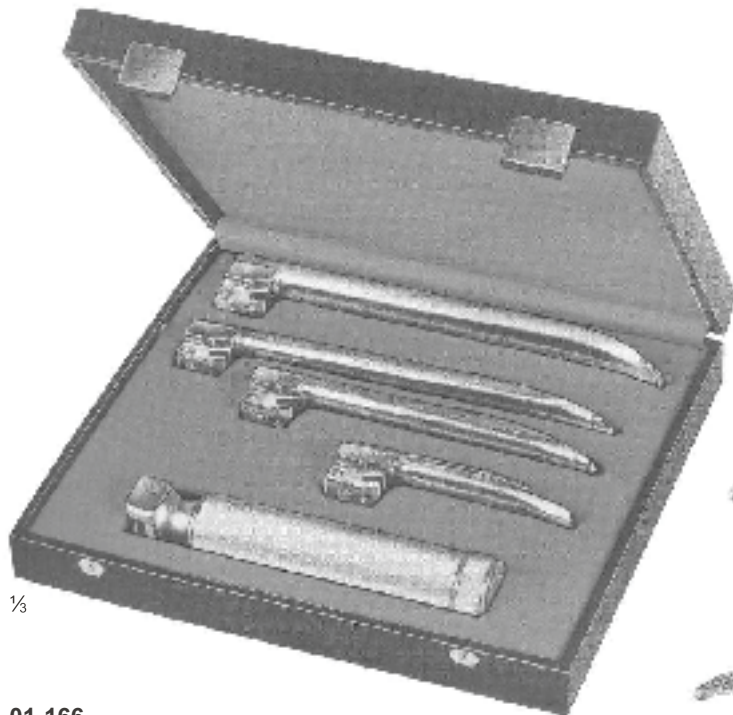

1/3

01-166
MILLER
Laryngoscope Set, Consists Of Battery Handle (Without Battery)
With Four Miller Laryngoscope Blades

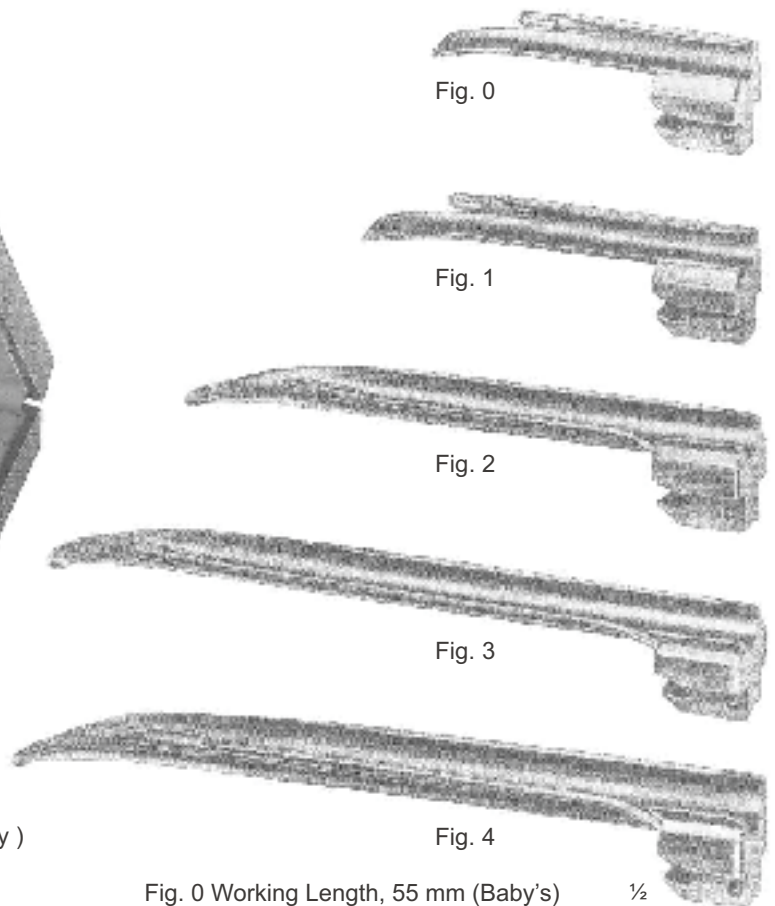

Fig. 0

Fig. 1

Fig. 2

Fig. 3

Fig. 4

Fig. 0 Working Length, 55 mm (Baby's) 1/2
Fig. 1 Working Length, 80 mm (Children's)
Fig. 2 Working Length, 130 mm (Adolescent's)
Fig. 3 Working Length, 170 mm (Women's)
Fig. 4 Working Length, 180 mm (Men's)



1/3

01-167
GUEDEL-NEGUS
Laryngoscope Set, Consists Of Battery Handle (Without Battery)
With Four Miller Laryngoscope Blades

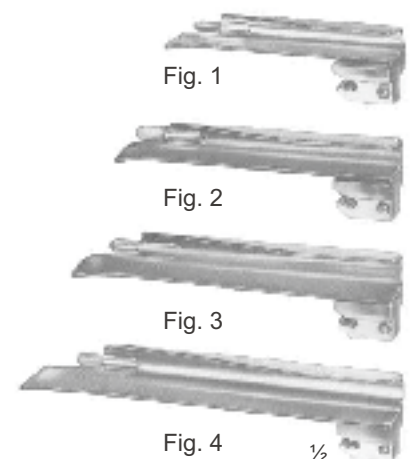

Fig. 1

Fig. 2

Fig. 3

Fig. 4

Fig. 1 Working Length, 70 mm (Children's)
Fig. 2 Working Length, 90 mm (Adolescent's)
Fig. 3 Working Length, 110 mm (Women's)
Fig. 4 Working Length, 135 mm (Men's)

Diagnostic Sets



1/3

01-168
McIntosh
Laryngoscope Set, Consists Of Battery Handle (Without Battery)
With Three McIntosh Blades, Fig. 1, Fig. 2, Fig. 3

01-169
McIntosh
Laryngoscope Set, Consists Of Battery Handle (Without Battery)
With Five McIntosh Blades, Fig. 1, Fig. 2, Fig. 3, Fig. 4, Fig. 5



Fig. 0



Fig. 1



Fig. 2

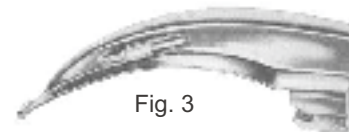

Fig. 3

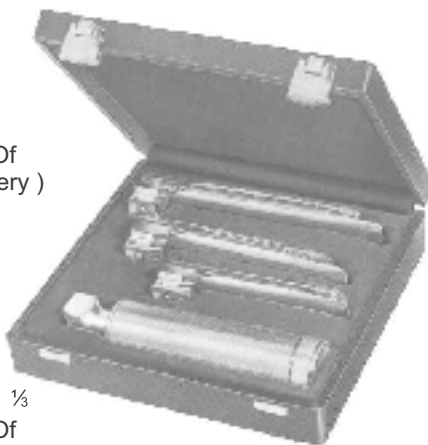

Fig. 4

1/2

Fig. 0 Working Length, 55 mm (Baby's)
Fig. 1 Working Length, 75 mm (Children's)
Fig. 2 Working Length, 90 mm (Adolescent's)
Fig. 3 Working Length, 110 mm (Women's)
Fig. 4 Working Length, 135 mm (Men's)

01-170
FOREGGER
Laryngoscope Set, Consists Of
Battery Handle (Without Battery)
With Three Foregger Blades,
Fig. 1, Fig. 2, Fig. 3,



1/3

01-171
FOREGGER
Laryngoscope Set, Consists Of
Battery Handle (Without Battery)
With Five Foregger Blades,
Fig. 1, Fig. 2, Fig. 3, Fig. 4, Fig. 5



Fig. 1

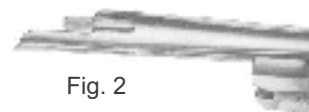

Fig. 2



Fig. 3



Fig. 4

1/2

Fig. 1 Working Length, 70 mm (Children's)
Fig. 2 Working Length, 90 mm (Adolescent's)
Fig. 3 Working Length, 110 mm (Women's)
Fig. 4 Working Length, 135 mm (Men's)



1/2

01-172
Fiber Optic
Battery Handle



1/2

01-173
Fiber Optic
Battery Handle



1/4

01-174
Replacement Lamp
(Krypton) 2.5 V



1/4

01-175
Replacement Lamp
(Halogen) 2.5 V

Examination & Measuring Instruments



1/2
01-176
Caliper Of Aluminum
Up To 180 mm



1/2
01-177
VERNIER
Universal Caliper Of Steel
Up To 120 mm



1/2
01-178
CAROLL
Size: 140 mm



1/2
01-179
TOWNLEY
Size: 100 mm



1/2
01-180
COLLIN
Druck Pressure 72 kg
Size: 125 mm



1/2
01-181
BERTILLON
Caliper For Measuring The Head
Size: 320 mm



1/4
01-182
CASTROVIEJO
Caliper



1/2
01-183
MOLTGEN
Goniometer



01-184
Size: 500 mm



01-185
Size: 150 mm

Dissecting Knives



1/2

02-101 - 110
Fig. 1 - 10



1/4

02-101
Fig. 1



02-102
Fig. 2



02-103
Fig. 3



02-104
Fig. 4



02-105
Fig. 5



1/4

02-106
Fig. 6



02-107
Fig. 7



02-108
Fig. 8



02-109
Fig. 9



02-110
Fig. 10

Autopsy & Cartilage Knives

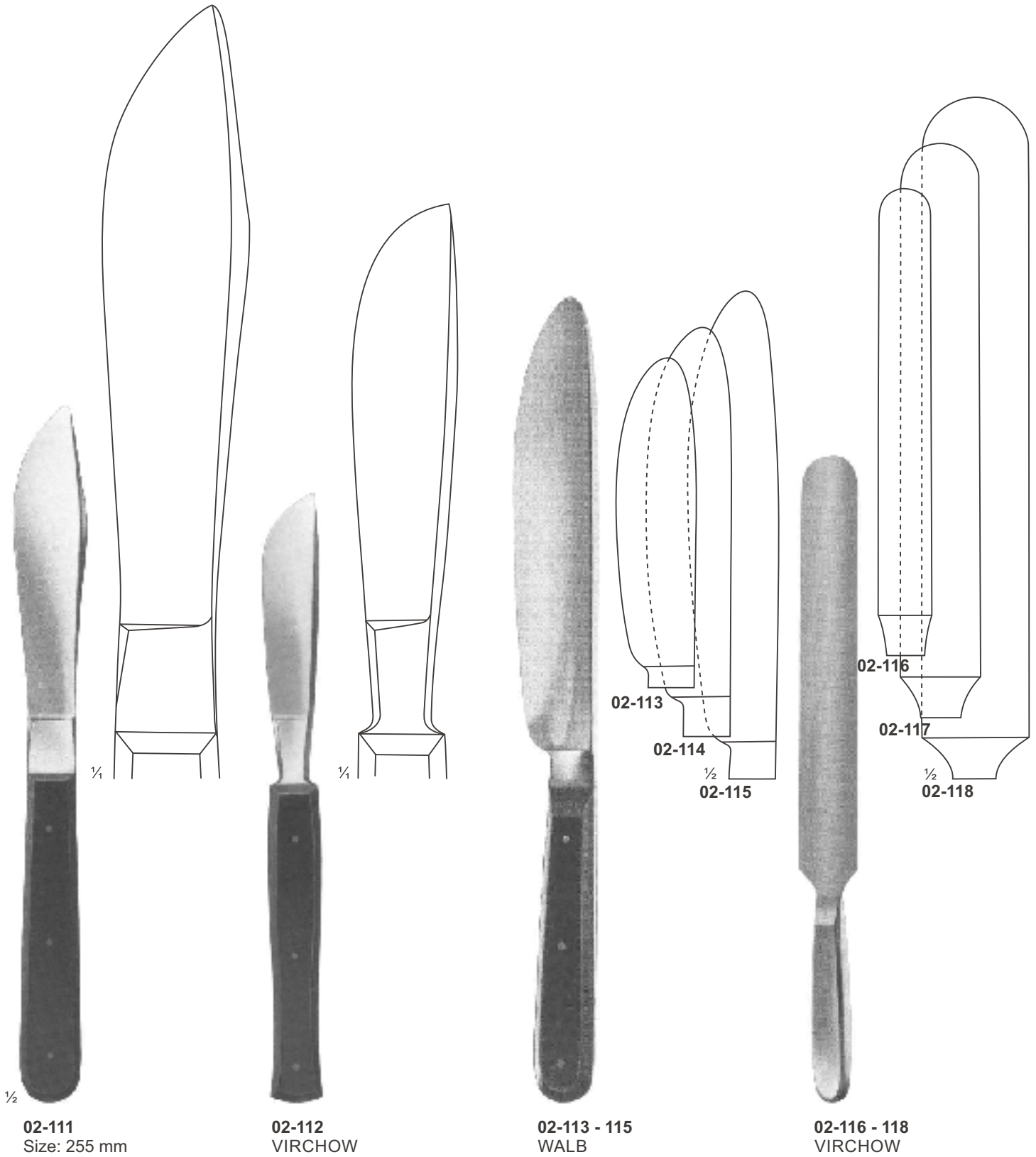

$\frac{1}{2}$

02-111
Size: 255 mm

$\frac{1}{4}$

02-112
VIRCHOW

02-113

02-114

$\frac{1}{2}$
02-115

02-113 - 115
WALB

02-116

02-117

$\frac{1}{2}$
02-118

02-116 - 118
VIRCHOW

Scalpels, Tenotomes & Resection Knives

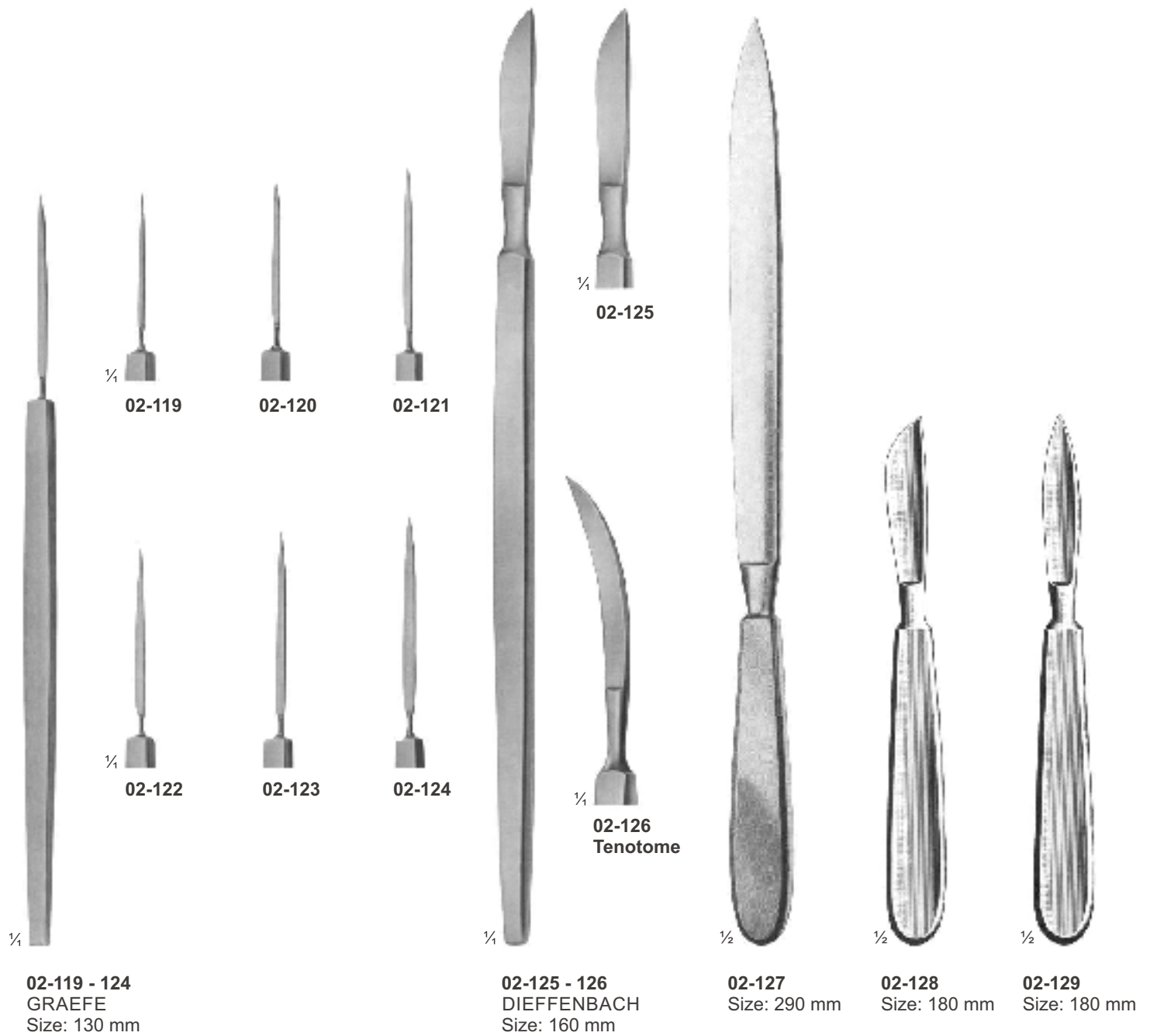

Scalpels, Tenotomes

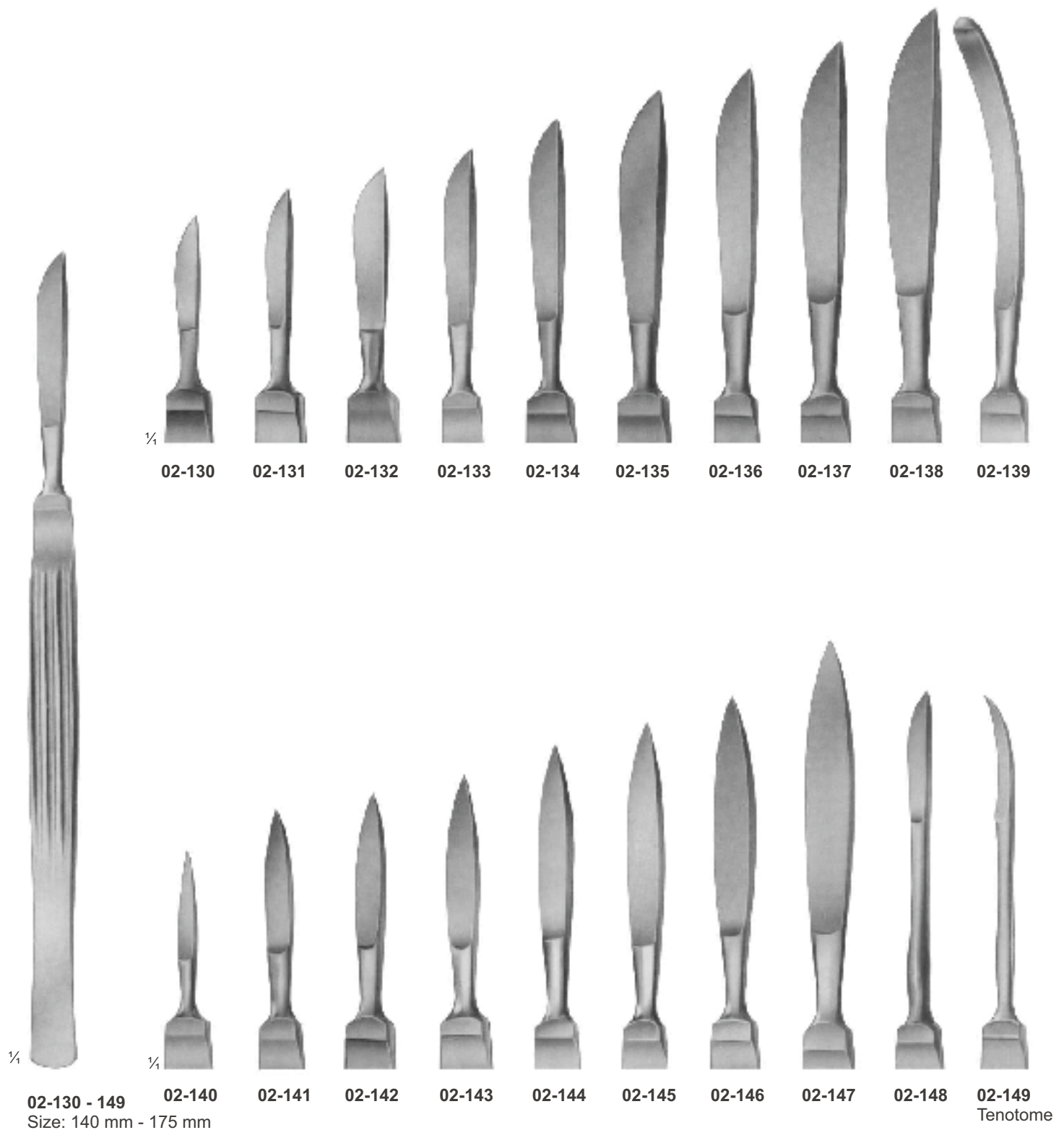

Amputating Knives, Cartilage Knives, Autopsy Knives



02-150
Size: 130 mm
02-151
Size: 160 mm
02-152
Size: 190 mm
02-153
Size: 200 mm

02-154
CATLIN
Size: 160 mm
Blade Length
Amputating
Knives

02-155
LANGENBECK
Size: 120 mm
Blade Length
Flap Knives

02-156
Size: 110 mm
Blade Length
Interosseous
Knives

02-157
Size: 55 mm
Blade Length
With Raspatory,
Wooden Handle

02-158
Size: 70 mm
Blade Length
Wooden Handle

02-159
Size: 80 mm
Blade Length
Metal Handle

02-160
Size: 195 mm
Blade Length
Metal Handle

Blade Length
Amputating Knives

Cone Knives, Myomatome, Trigeminal & Tonsil Knives



02-161

AYRE

Size: 235 mm
Cone Knife

02-162

Size: 230 mm
Cone Knife

02-163

SEGOND

Size: 270 mm
Myomatome

02-164

OLIVECRONA
Size: 205 mm
Trigeminal
Knife

02-165

Size: 230 mm
Trigeminal
Knife

02-166

FOWLER
Size: 200 mm
Tonsil Knife

02-167

ABRAHAM
Size: 215 mm
Tonsil Knife

02-168

BRUNINGS
Size: 215 mm
Tonsil Knife

Scalpels, Dura Knives & Comedone Extractors

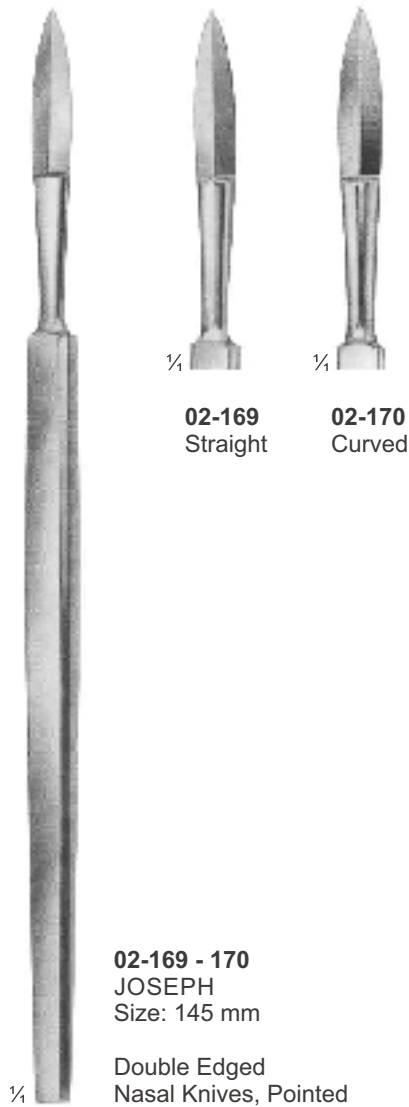

02-169
Straight

02-170
Curved

02-169 - 170
JOSEPH
Size: 145 mm

Double Edged
Nasal Knives, Pointed

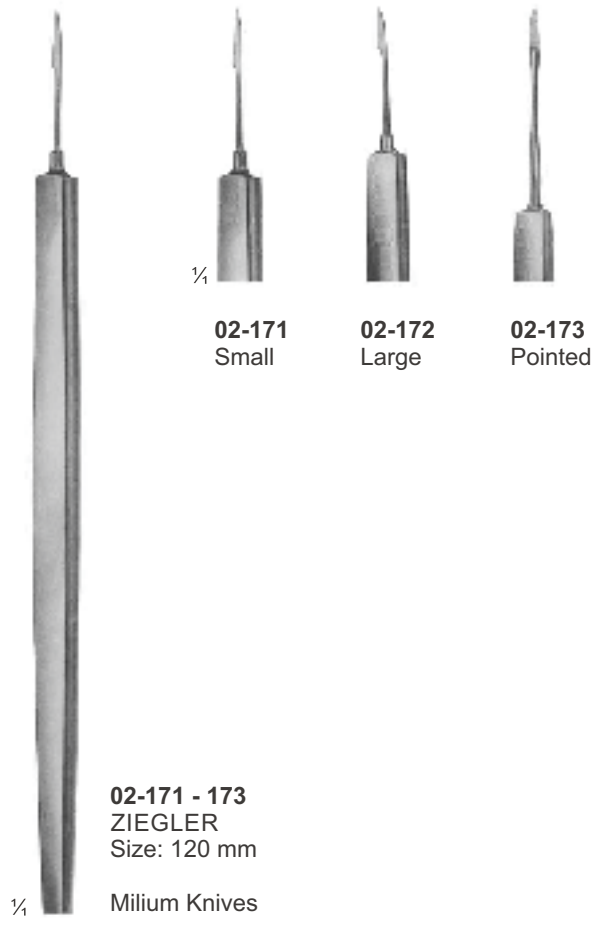

02-171
Small

02-172
Large

02-173
Pointed

02-171 - 173
ZIEGLER
Size: 120 mm

Millium Knives

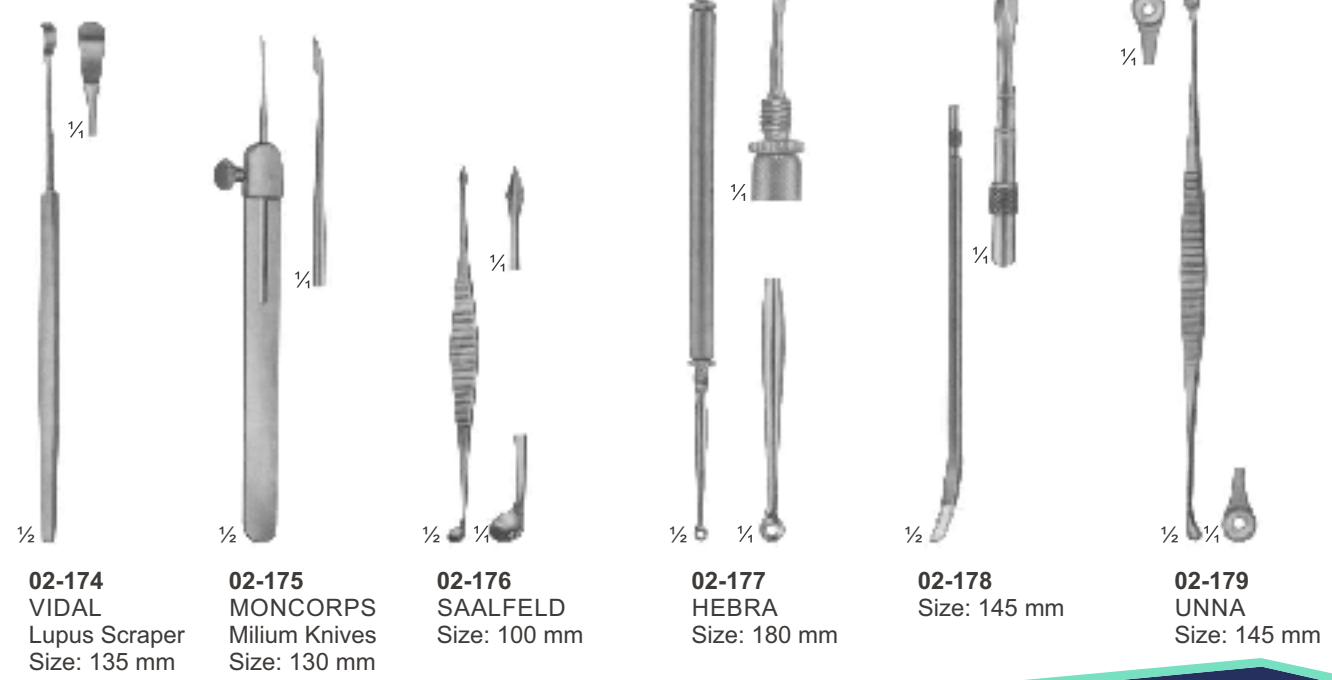

02-174
VIDAL
Lupus Scraper
Size: 135 mm

02-175
MONCORPS
Millium Knives
Size: 130 mm

02-176
SAALFELD
Size: 100 mm

02-177
HEBRA
Size: 180 mm

02-178
Size: 145 mm

02-179
UNNA
Size: 145 mm

Razor Blade Holders & Breakers



02-180
TROUTMAN-CHRIS
Size: 100 mm



02-181
TROUTMAN-CHRIS
Size: 100 mm

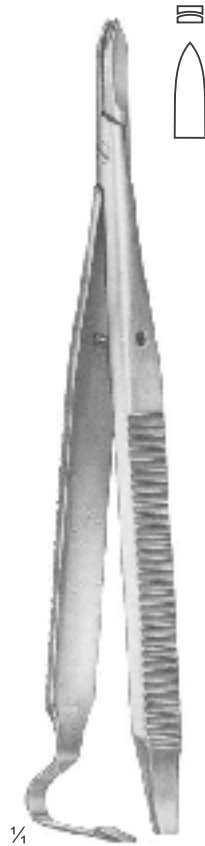

02-182
Size: 110 mm



02-183
CASTROVIEJO
Size: 130 mm



02-184
Size: 185 mm

Scalpel Handles

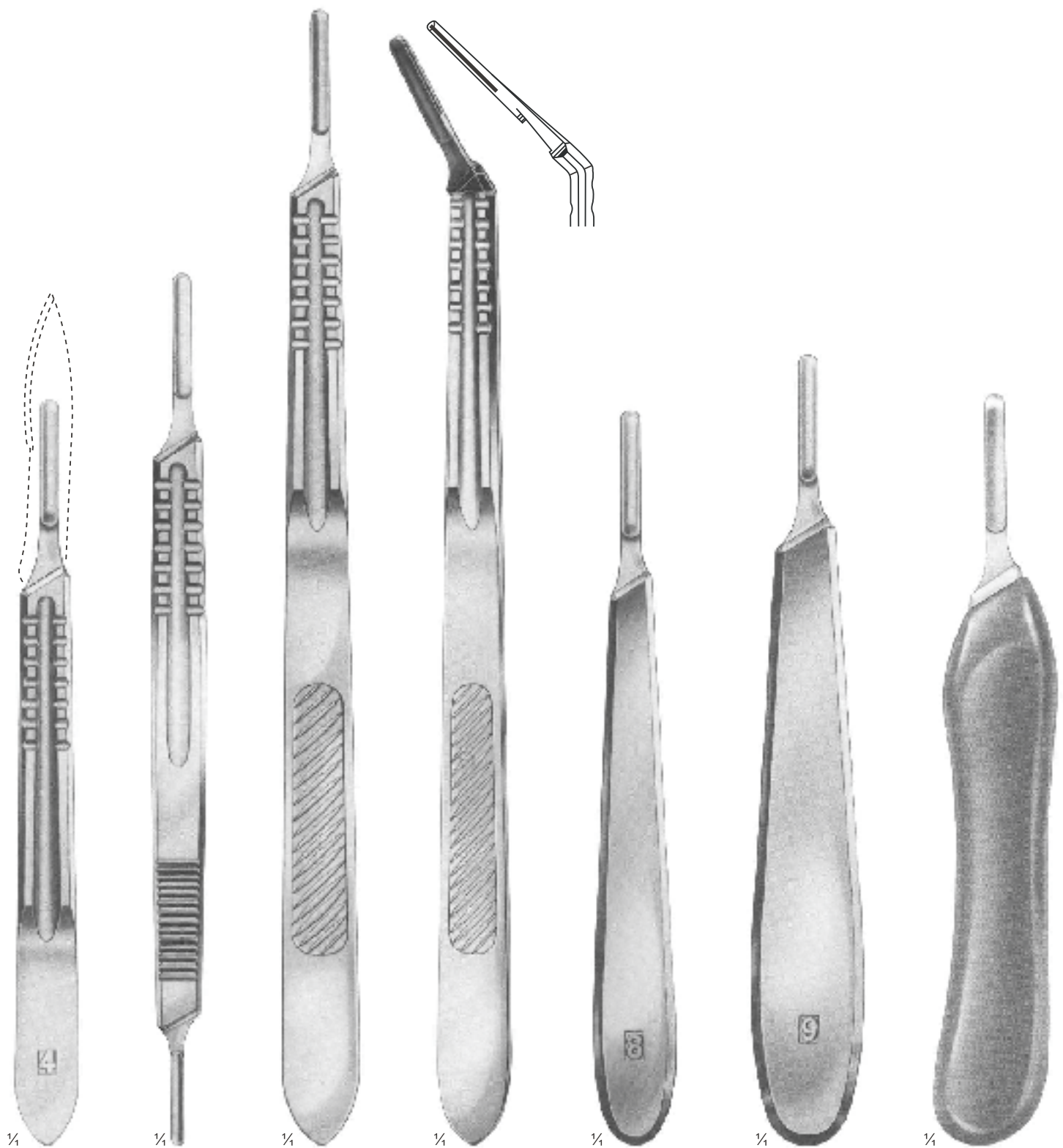

02-185
STANDARD
No. 4
Solid

02-186
Double Handel
No. 4 + No. 3
Solid

02-187
No. 4 L
Straight
Solid

02-188
No. 4 L
Solid Angled

02-189
COLLIN
No. 8
Hollow

02-190
COLLIN
No. 9
Hollow

02-191
Plastic

Scalpel Handles

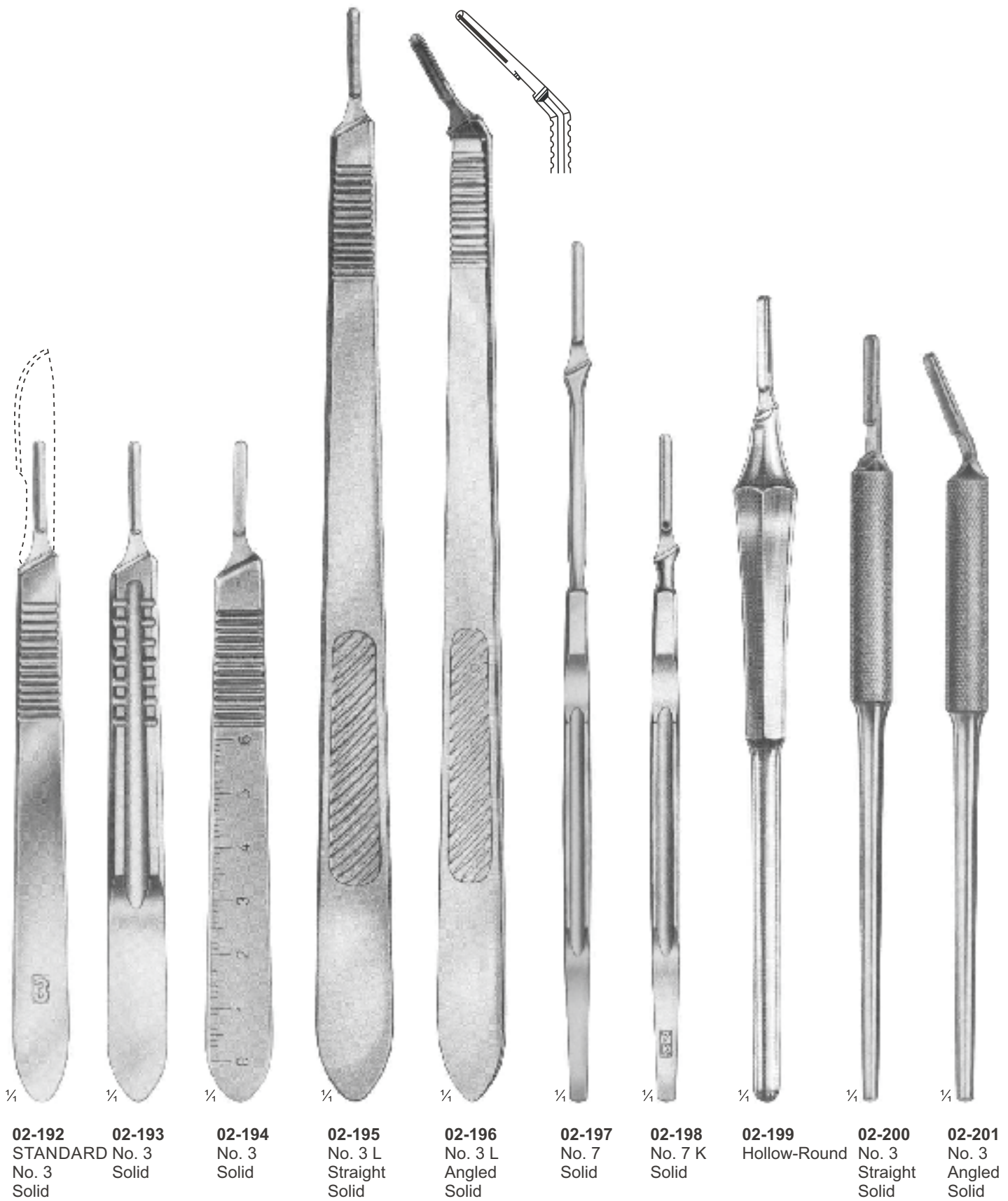

¼ ¼ ¼ ¼ ¼ ¼ ¼ ¼ ¼ ¼

| | | | | | | | | | |
|---|---------------------------------|---------------------------------|---|---|---------------------------------|-----------------------------------|-------------------------------|---|---|
| 02-192 STANDARD No. 3 Solid | 02-193 No. 3 Solid | 02-194 No. 3 Solid | 02-195 No. 3 L Straight Solid | 02-196 No. 3 L Angled Solid | 02-197 No. 7 Solid | 02-198 No. 7 K Solid | 02-199 Hollow-Round | 02-200 No. 3 Straight Solid | 02-201 No. 3 Angled Solid |
|---|---------------------------------|---------------------------------|---|---|---------------------------------|-----------------------------------|-------------------------------|---|---|

Micro Scissors, "Spring Type" Flat Handles

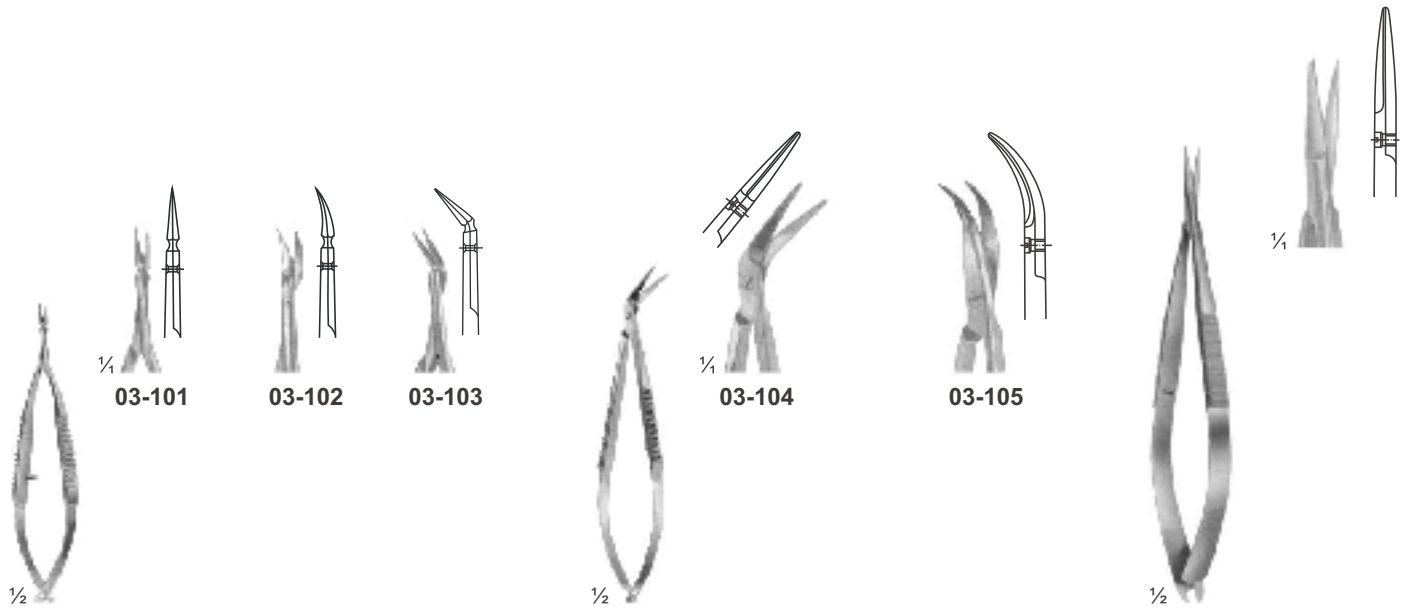

03-101 - 103
VANNAS
Size: 85 mm

03-104 - 105
CASTROVIEJO
Size: 95 mm

03-106
NOYES
Size: 125 mm

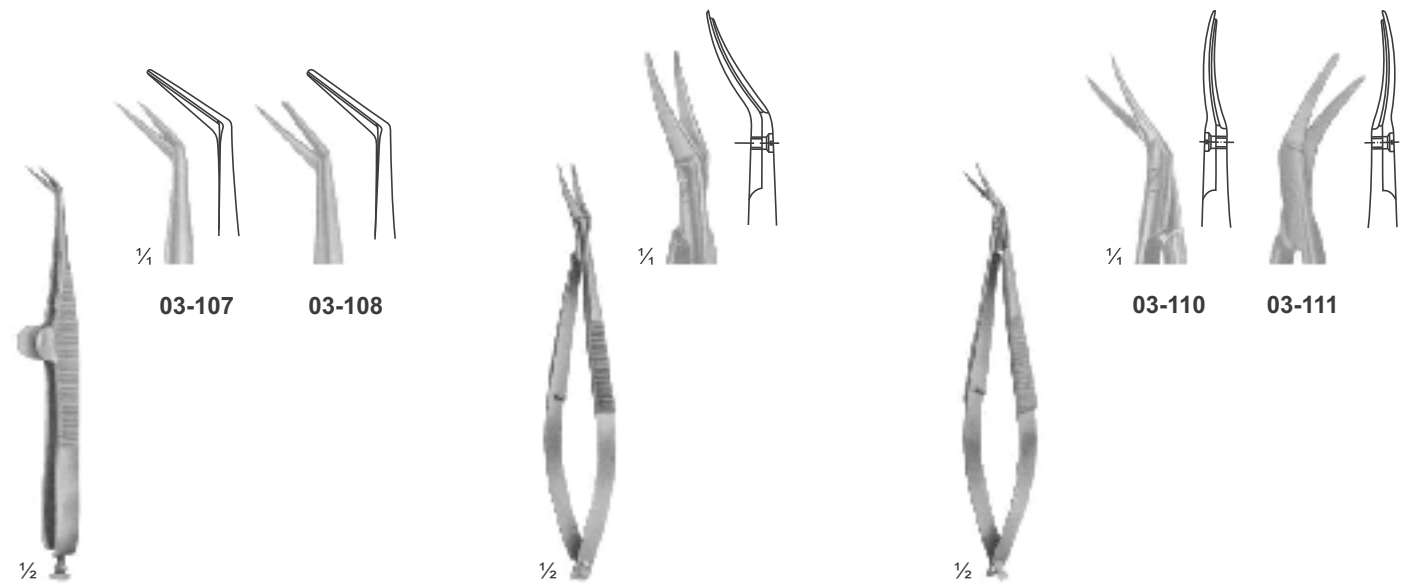

03-107 - 108
WECKER
Eye Scissor
Size: 110 mm

03-109
CASTROVIEJO
Eye Scissor
Size: 115 mm

03-110 - 111
CASTROVIEJO
Eye Scissor
Size: 110 mm

Micro Scissors, "Spring Type" Flat Handles

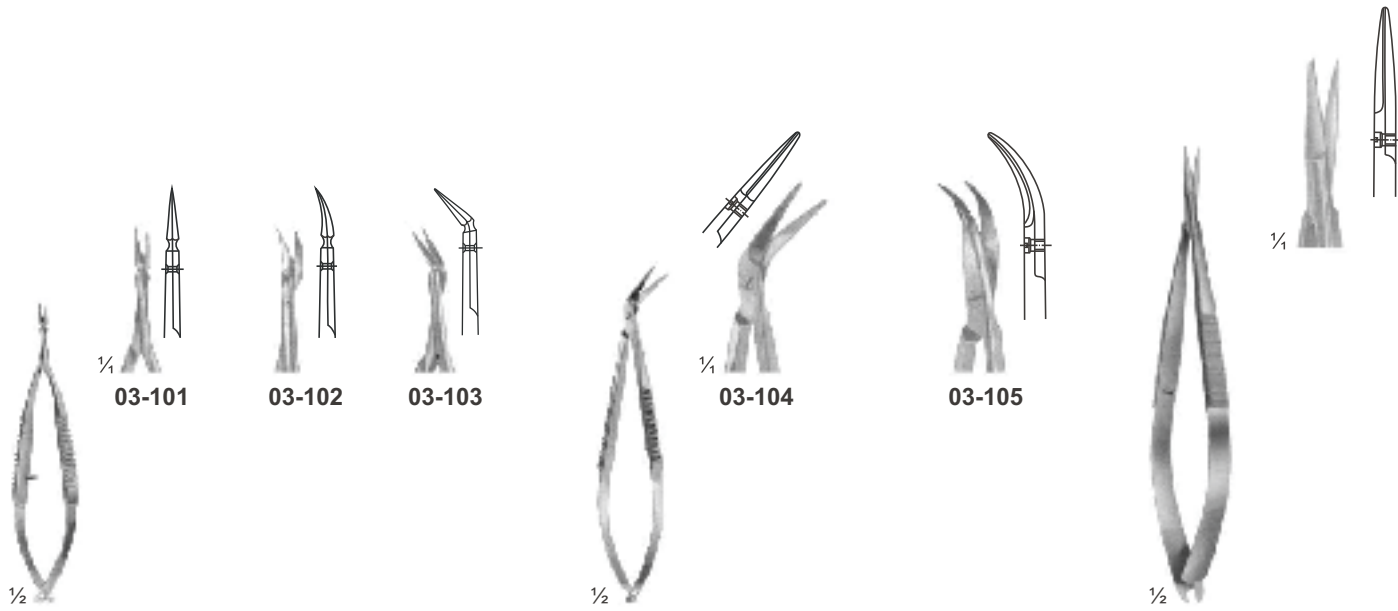

03-101 - 103
VANNAS
Size: 85 mm

03-104 - 105
CASTROVIEJO
Size: 95 mm

03-106
NOYES
Size: 125 mm

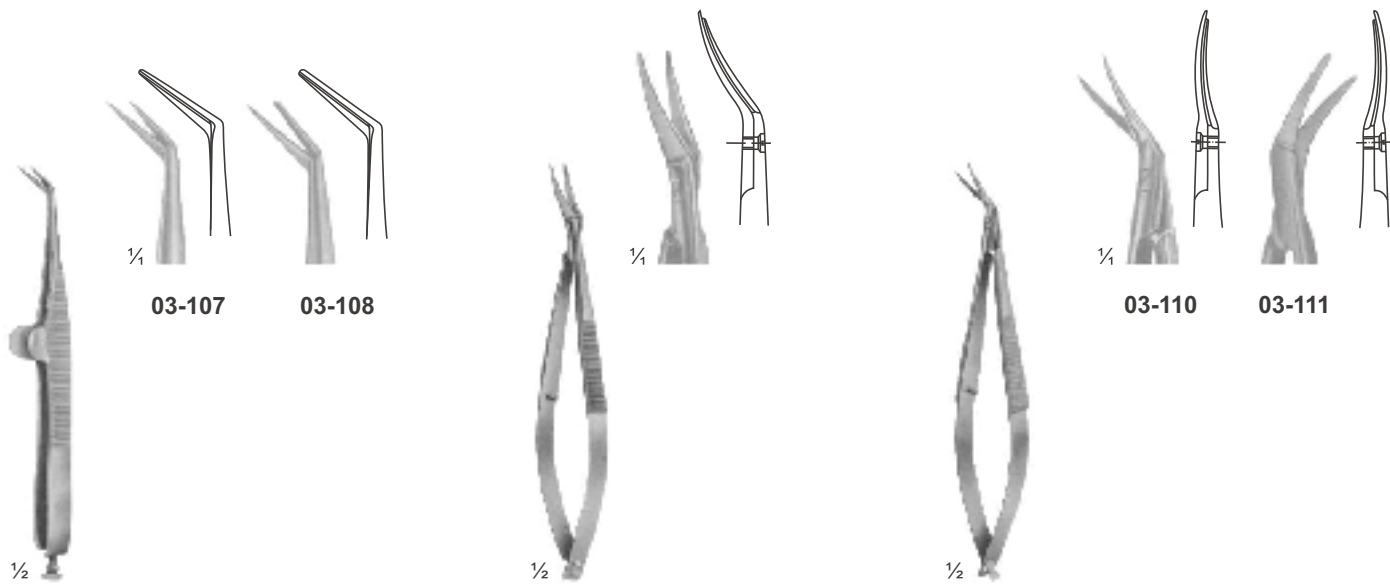

03-107 - 108
WECKER
Eye Scissor
Size: 110 mm

03-109
CASTROVIEJO
Eye Scissor
Size: 115 mm

03-110 - 111
CASTROVIEJO
Eye Scissor
Size: 110 mm

Micro Scissors, "Spring Type" Flat Handles

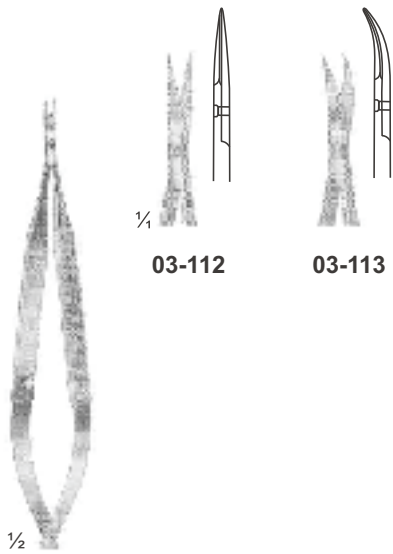

03-112

03-113

03-112 - 113
Size: 120 mm

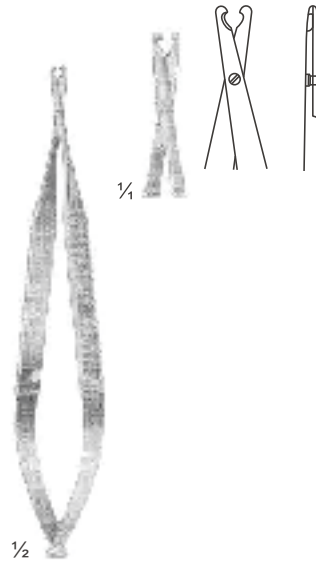

03-114
BIEMER
Vein Scissor
Size: 130 mm

03-115
Size: 160 mm

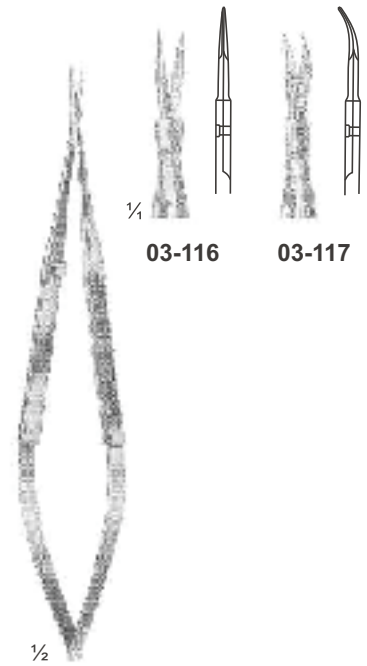

03-116

03-117

03-116 - 117
VANNAS
Size: 160 mm

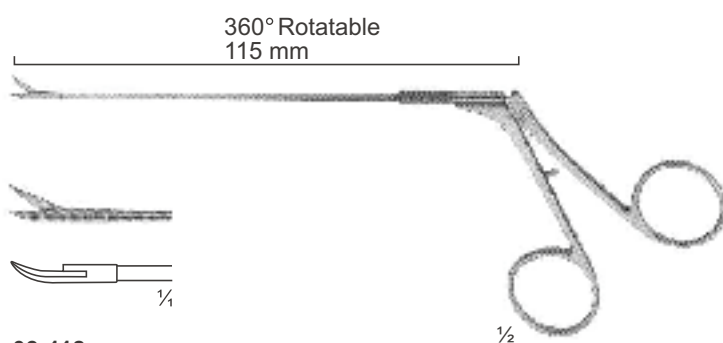

03-118
CASPAR
Micro Scissor Curved
Size: 115 mm

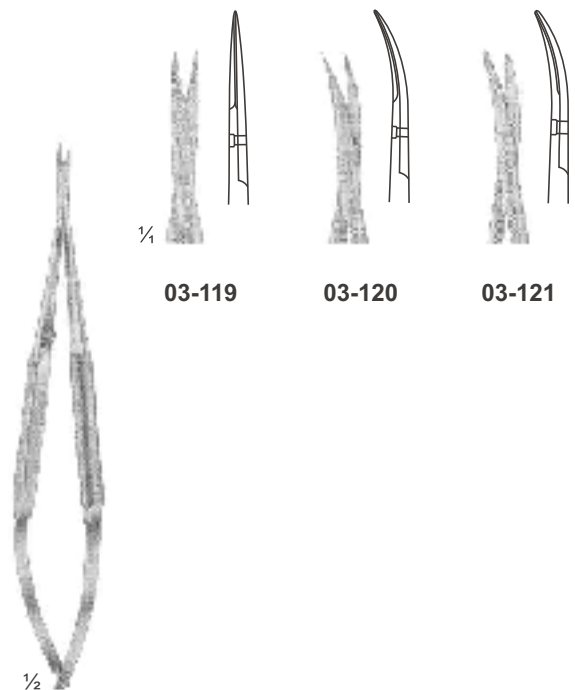

1/4

03-119

03-120

03-121

1/2

03-119 - 121
Micro Dissecting Scissor
Size: 145 mm

Micro Scissors, "Spring Type" Bayonet Shape



03-122
YASARGIL
Size: 245 mm



03-123 - 124
Laterally Angled
Size: 200 mm



03-125
Laterally Angled
Size: 190 mm

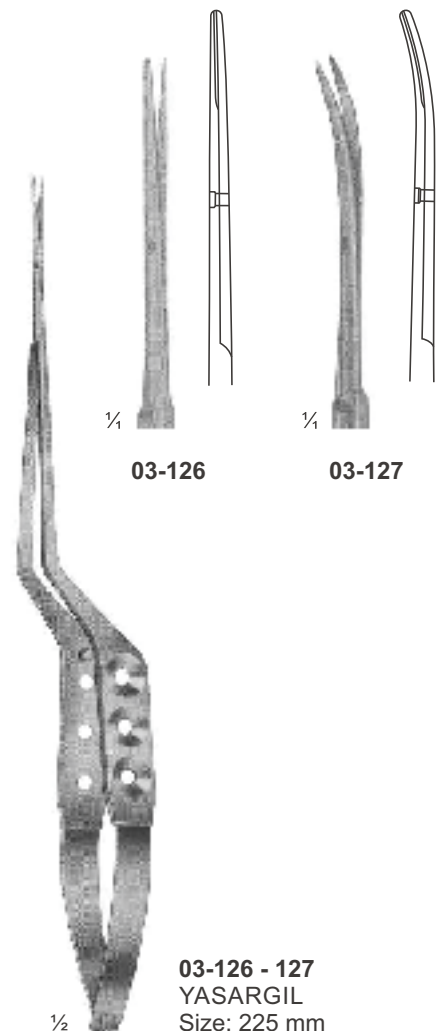

03-126 - 127
YASARGIL
Size: 225 mm

Delicate Scissors

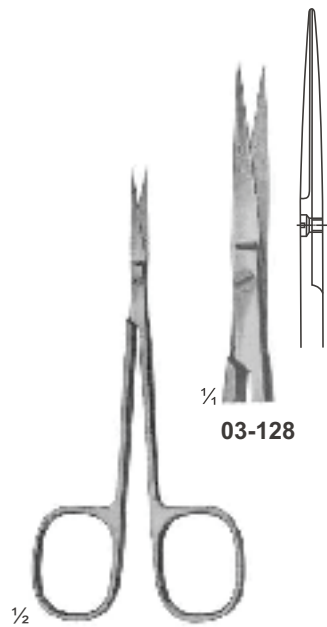

1/4
03-128

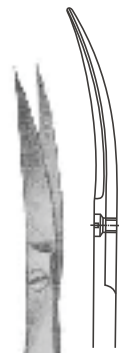

03-129

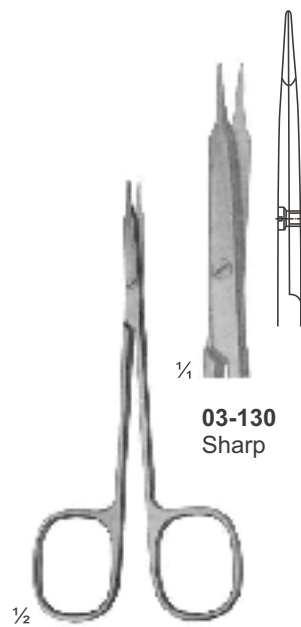

1/4
03-130
Sharp

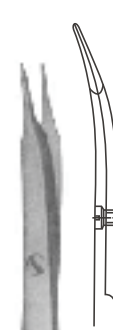

03-131
Sharp

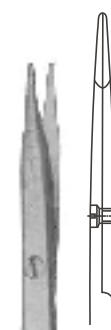

03-132
Blunt

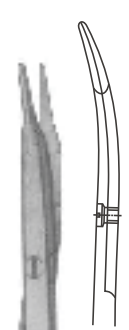

03-133
Blunt

03-128 - 129
Size: 120 mm

03-130 - 133
STEVENS
Dissecting Scissors
Size: 115 mm

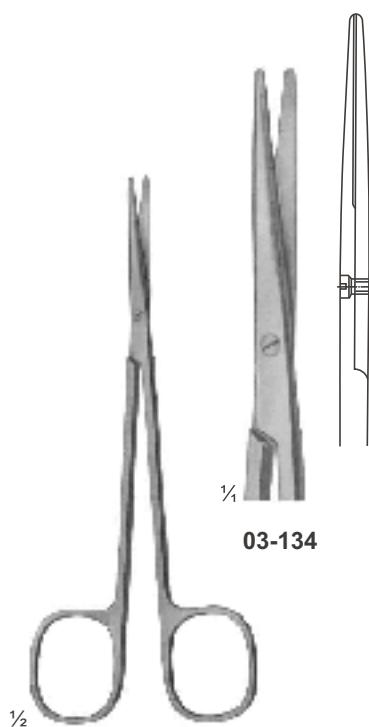

1/4
03-134

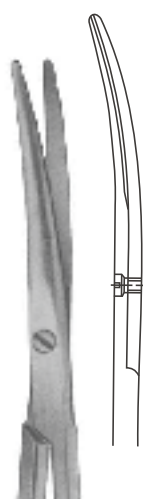

03-135

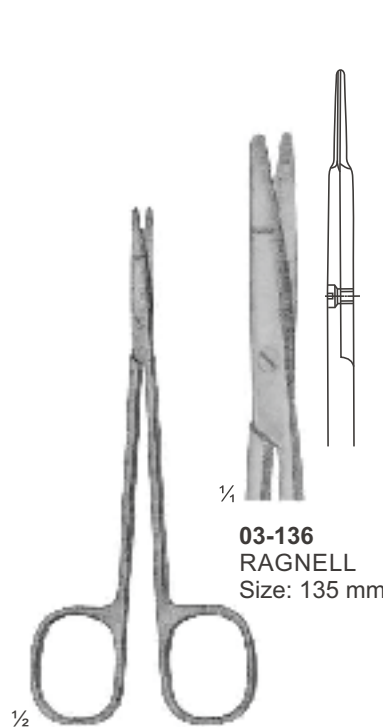

1/4
03-136
RAGNELL
Size: 135 mm

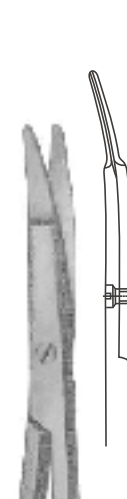

03-137
RAGNELL
Size: 135 mm

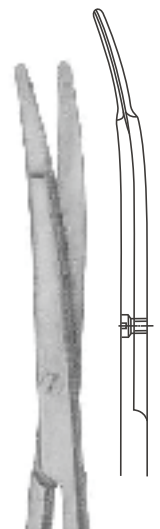

03-138
Size: 150 mm

03-134 - 135
METZENBAUM
Dissecting Scissors
Size: 145 mm

03-136 - 138
Special flat points for
dissecting and
undermining the skin
Size: 145 mm

Delicate Scissors

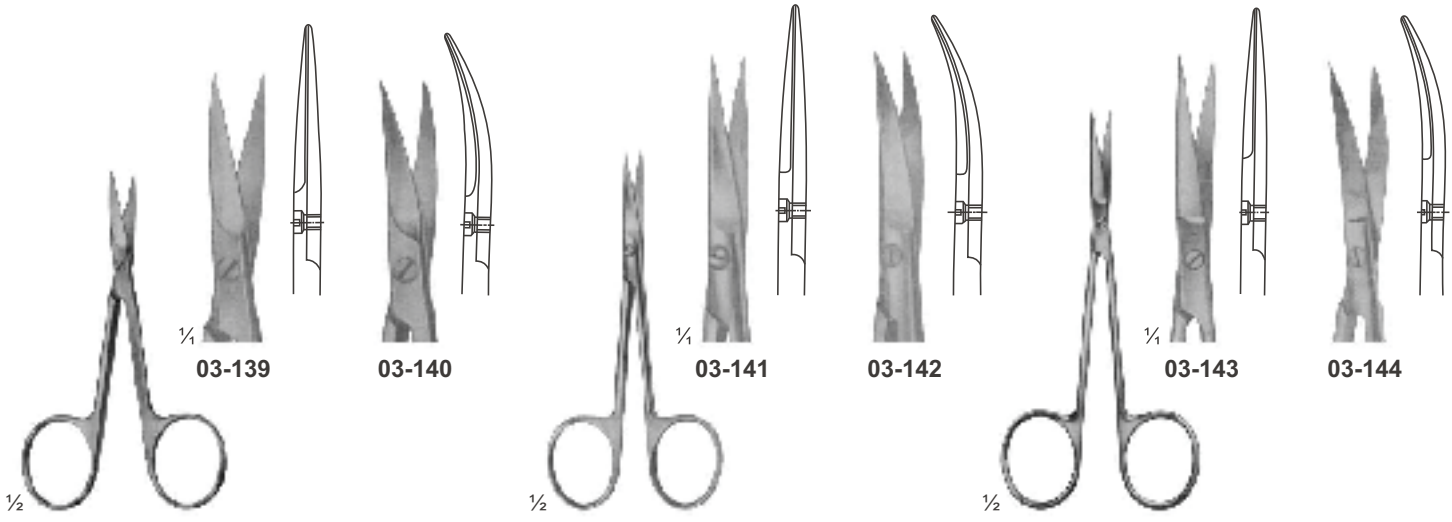

03-139 - 140
Size: 90 mm

03-141 - 142
Size: 95 mm

03-143 - 144
Size: 105 mm

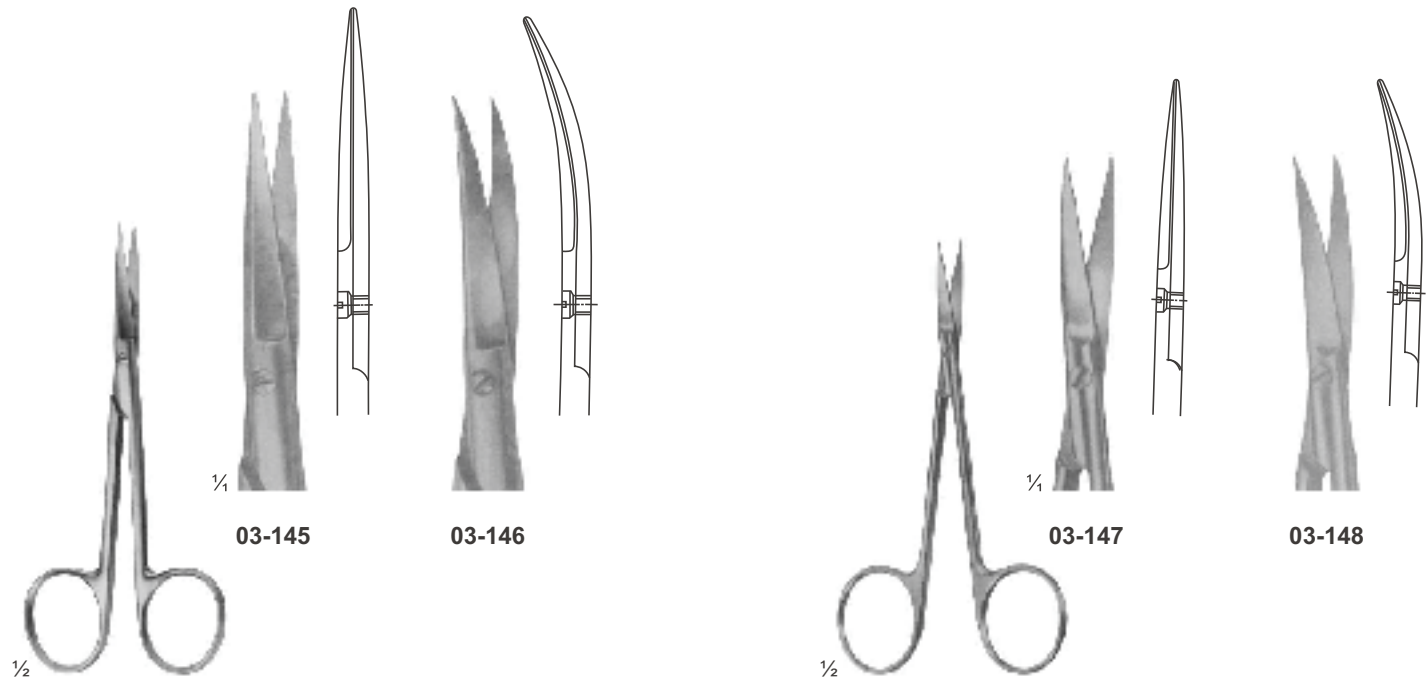

03-145 - 146
Size: 120 mm

03-147 - 148
Size: 115 mm

Delicate Scissors



½

03-149 - 151
Size: 120 mm

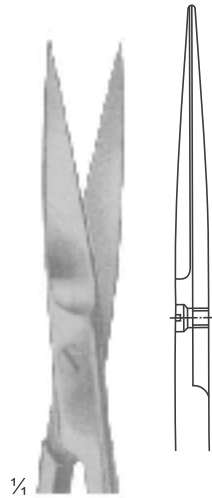

¼

03-149

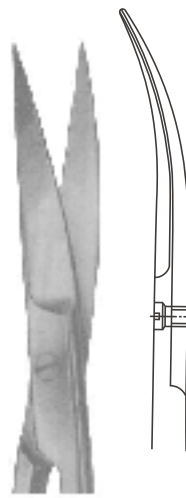

03-150

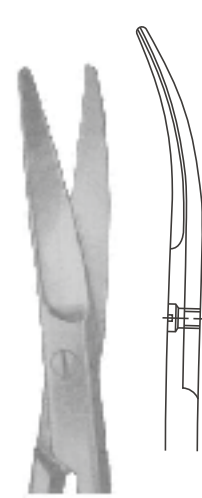

03-151



½

03-152 - 155
Size: 130 mm

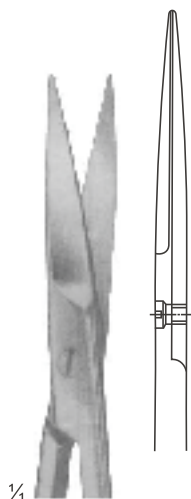

¼

03-152

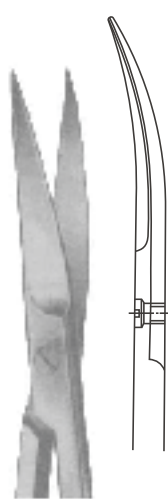

03-153

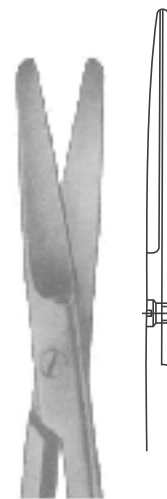

03-154

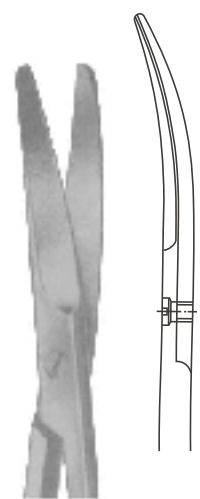

03-155

Delicate Scissors

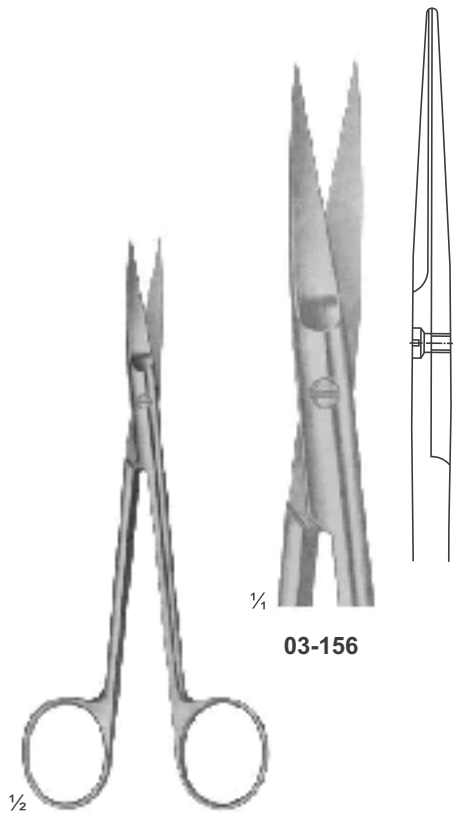

03-156

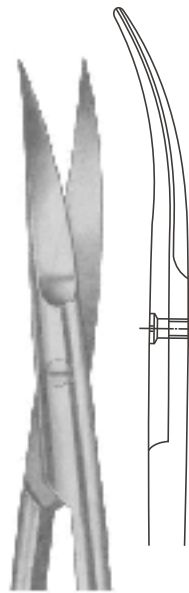

03-157

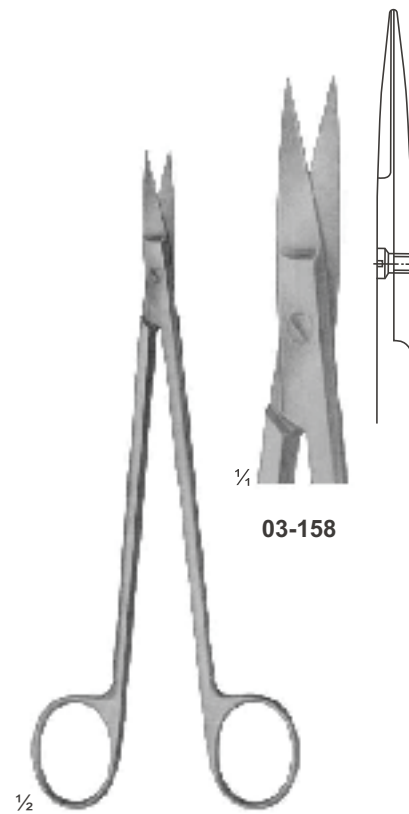

03-158

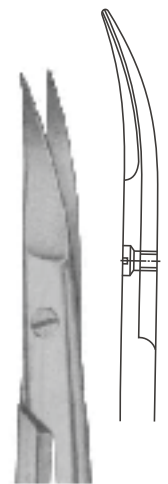

03-159

03-156 - 157
JOSEPH
Size: 150 mm

03-158 - 159
KELLY
Size: 175 mm

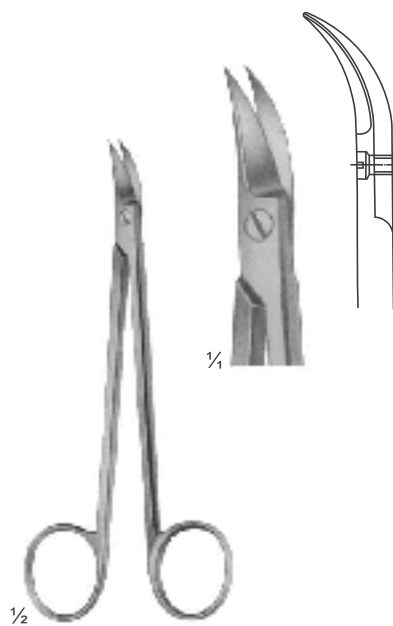

03-160
QUINBY
Size: 130 mm

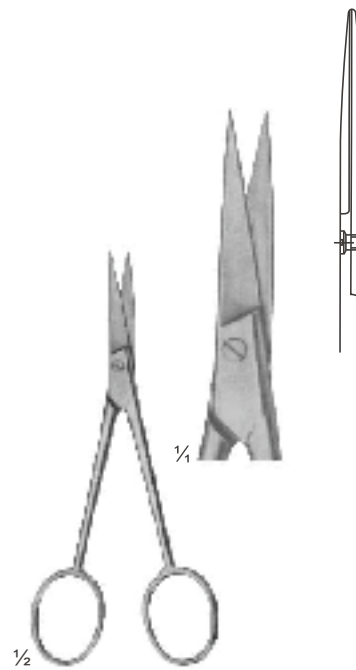

03-161
Size: 110 mm

Surgical Scissors

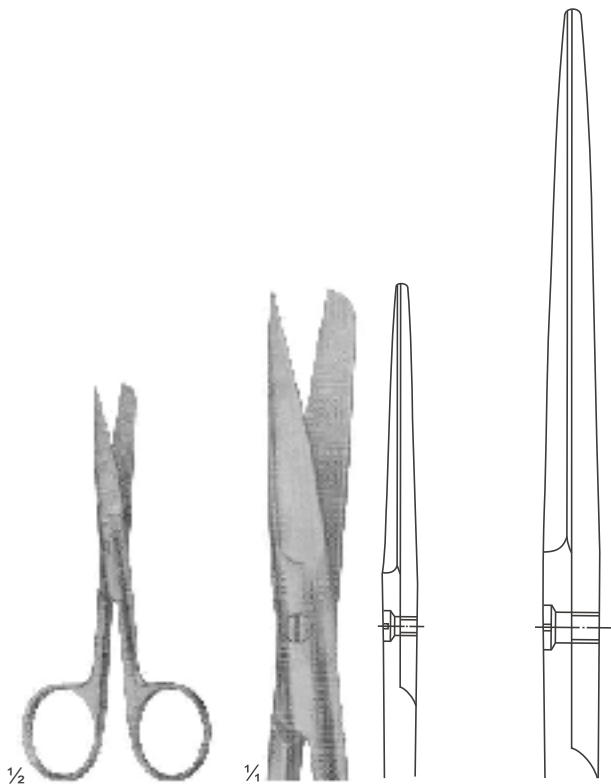

03-162 Size: 105 mm
03-170 Size: 200 mm



03-171 Size: 115 mm
03-177 Size: 185 mm

- 03-162 - 170 (Standard Types)**
03-162 (105 mm)
03-163 (115 mm)
03-164 (130 mm)
03-165 (145 mm)
03-166 (150 mm)
03-167 (165 mm)
03-168 (175 mm)
03-169 (185 mm)
03-170 (200 mm)

- 03-171 - 177 (Standard Types)**
03-171 (115 mm)
03-172 (130 mm)
03-173 (145 mm)
03-174 (150 mm)
03-175 (165 mm)
03-176 (175 mm)
03-177 (185 mm)

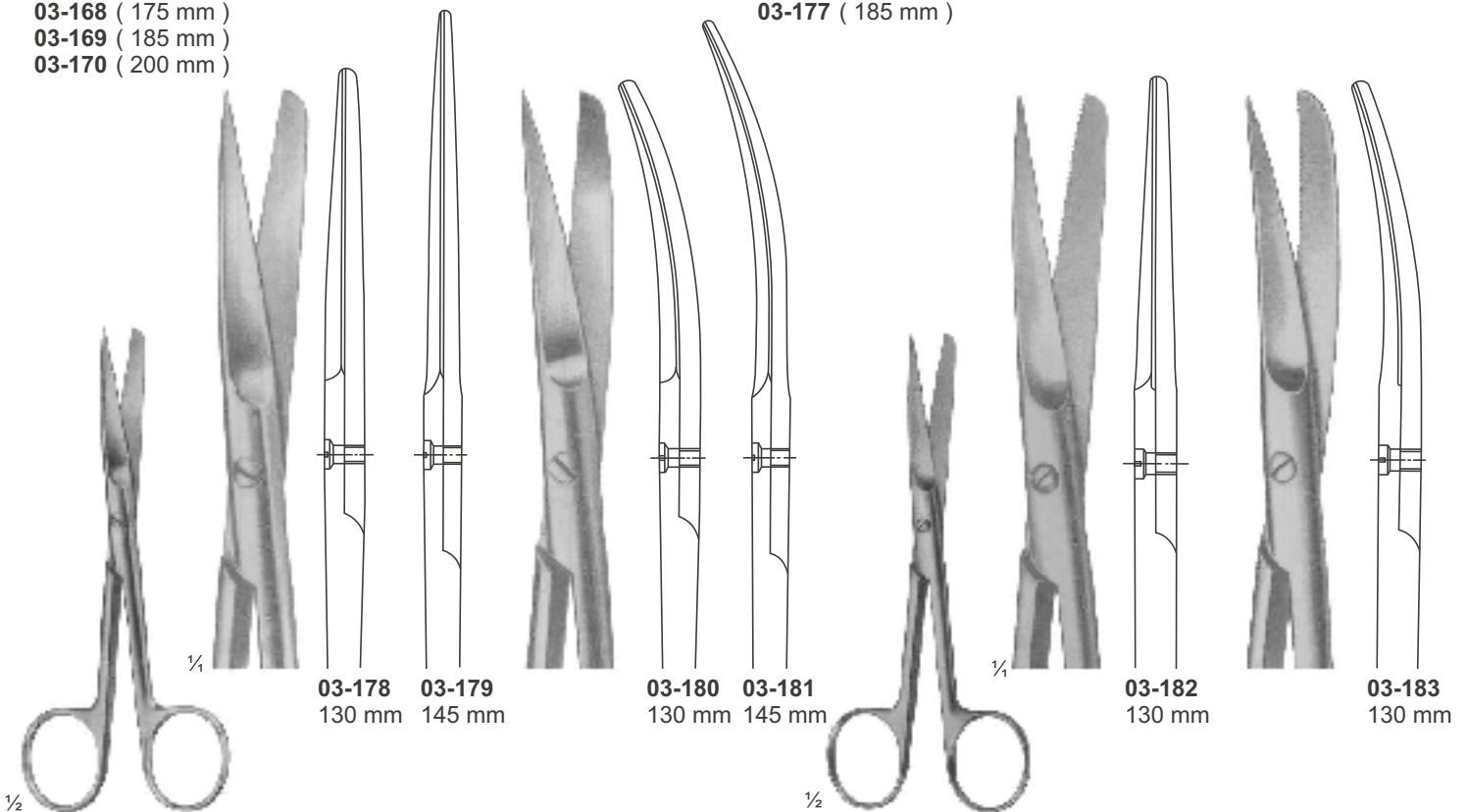

03-178 130 mm
03-179 145 mm

03-180 130 mm
03-181 145 mm

03-182 130 mm

03-183 130 mm

03-178 - 181
Slender Types

03-182 - 183
For Wound Edges
1 Blade Serrated

Surgical Scissors

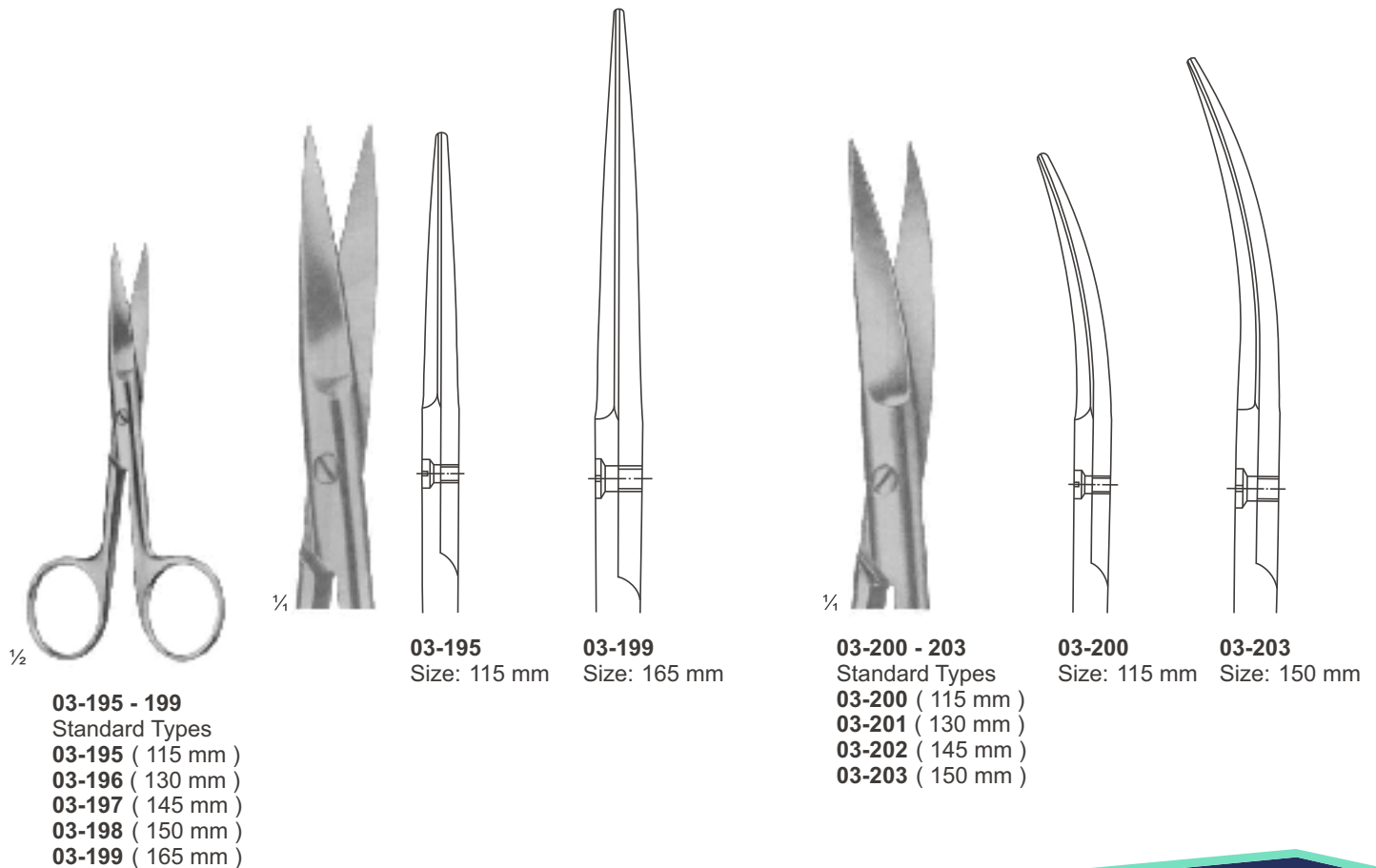
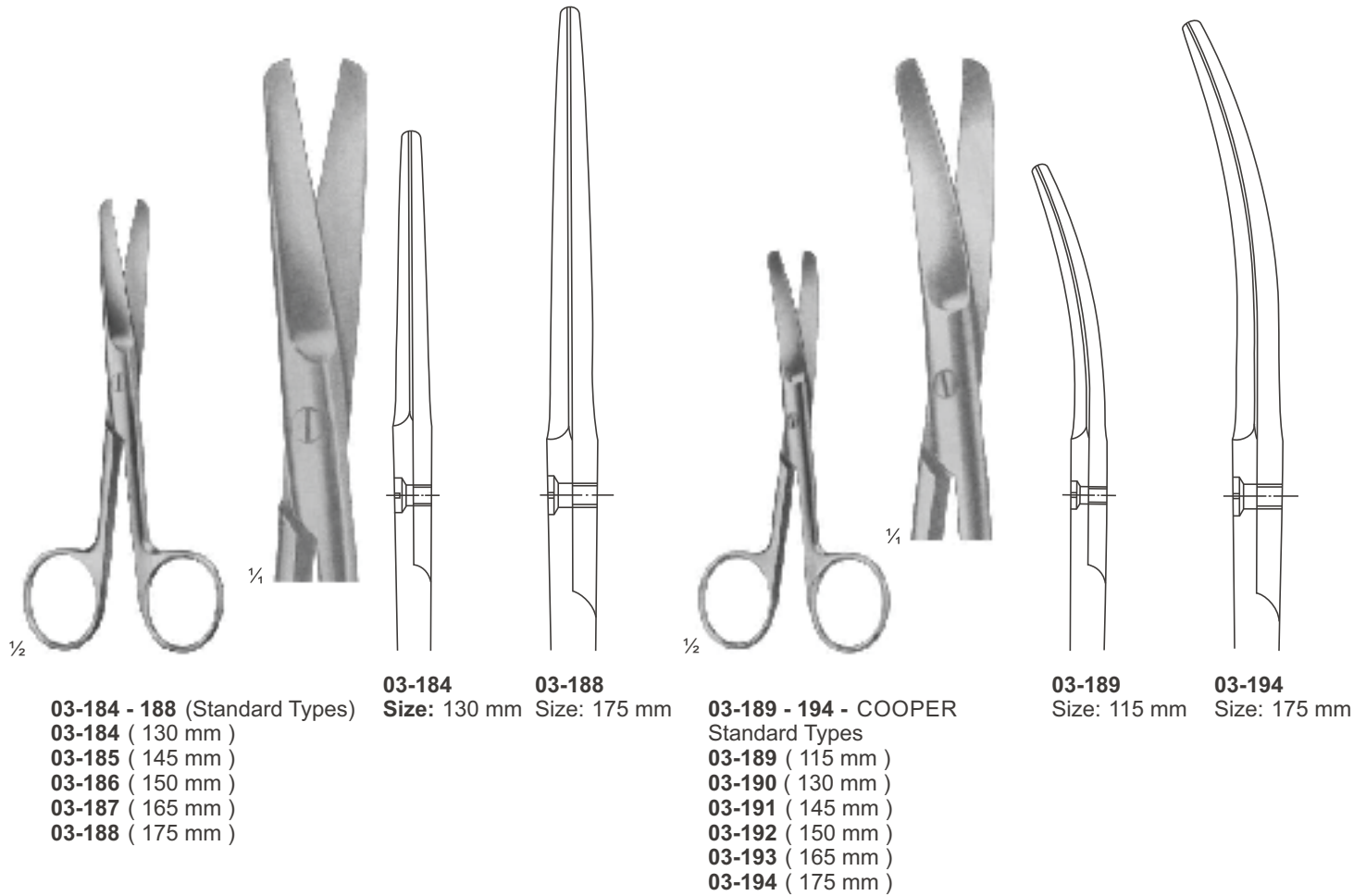

Surgical Scissors



03-204 - 206
DEAVER
With flat lock

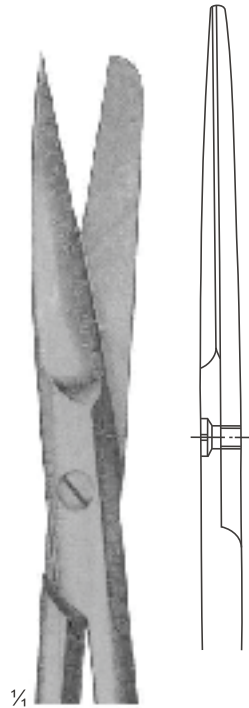

03-204
Size: 145 mm

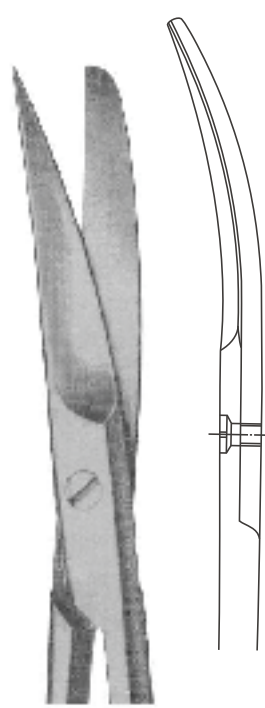

03-205
Size: 145 mm

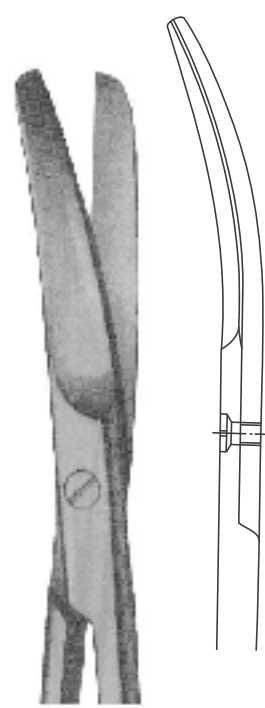

03-206
Size: 145 mm



03-207 - 209
Incision Scissors

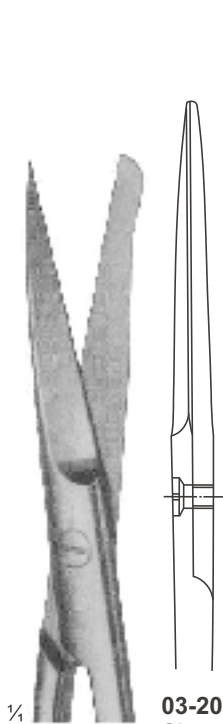

03-207
Size: 130 mm



03-208
Size: 145 mm

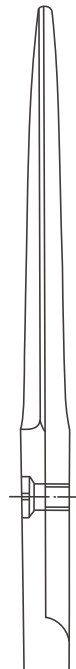

03-209
Size: 165 mm

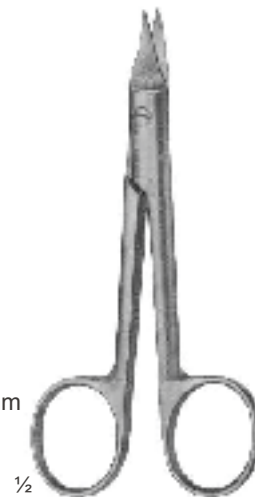

03-210
SYSTRUNK
Nail Splitting Scissors

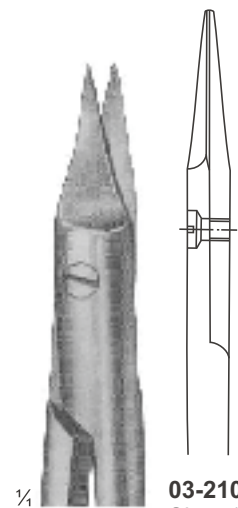

03-210
Size: 130 mm

Dissecting Scissors

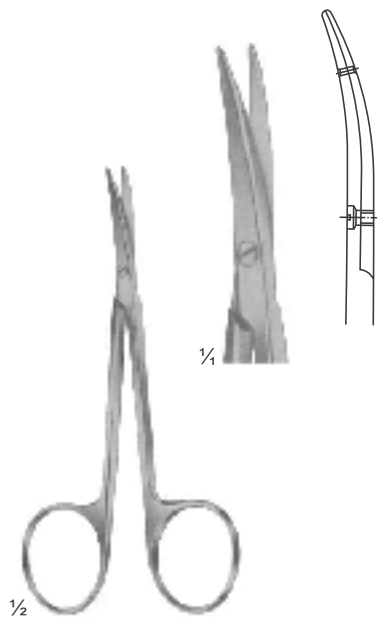

03-211
LITTLER
Dissecting Scissors
Tips with eye for suture
Size: 115 mm

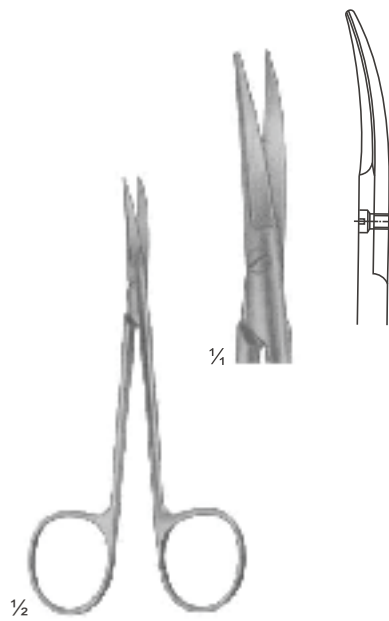

03-212
COTTLE
Bulldog Scissors
Size: 115 mm

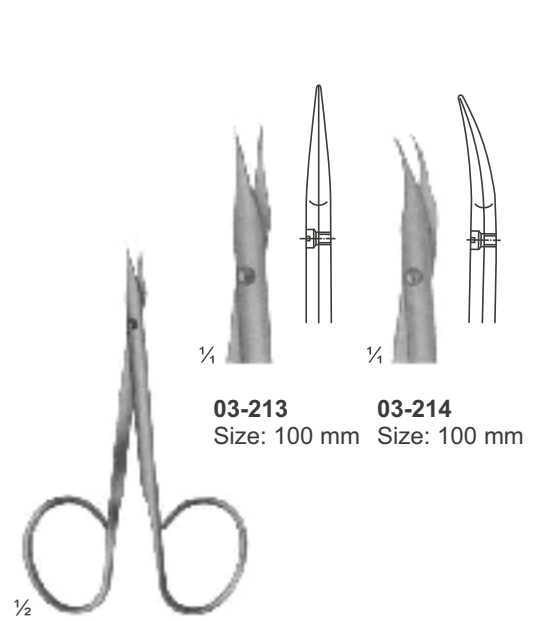

03-213 - 214
STEVENS
Vessel and tendon Scissors
Size: 100 mm

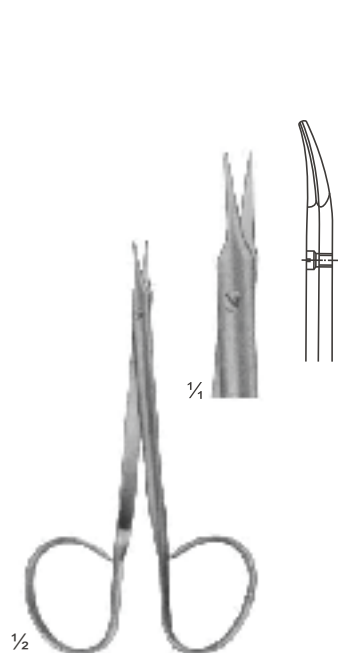

03-215
STEVENS
Fine Dissecting Scissors
Size: 110 mm

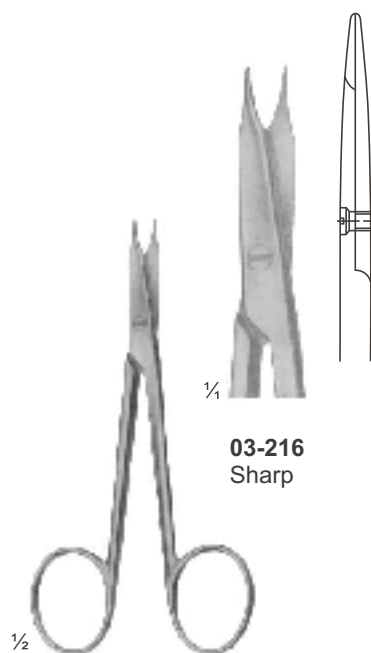

03-216 - 219
STEVENS
Vessel and tendon Scissors
Size: 110 mm

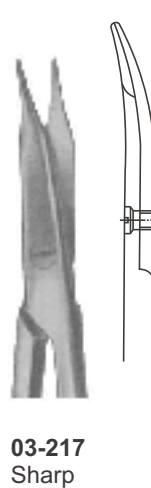

03-217
Sharp

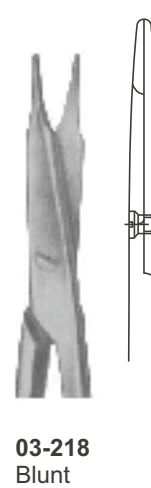

03-218
Blunt

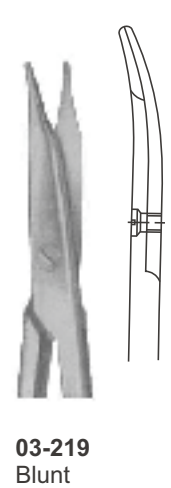

03-219
Blunt

Dissecting Scissors

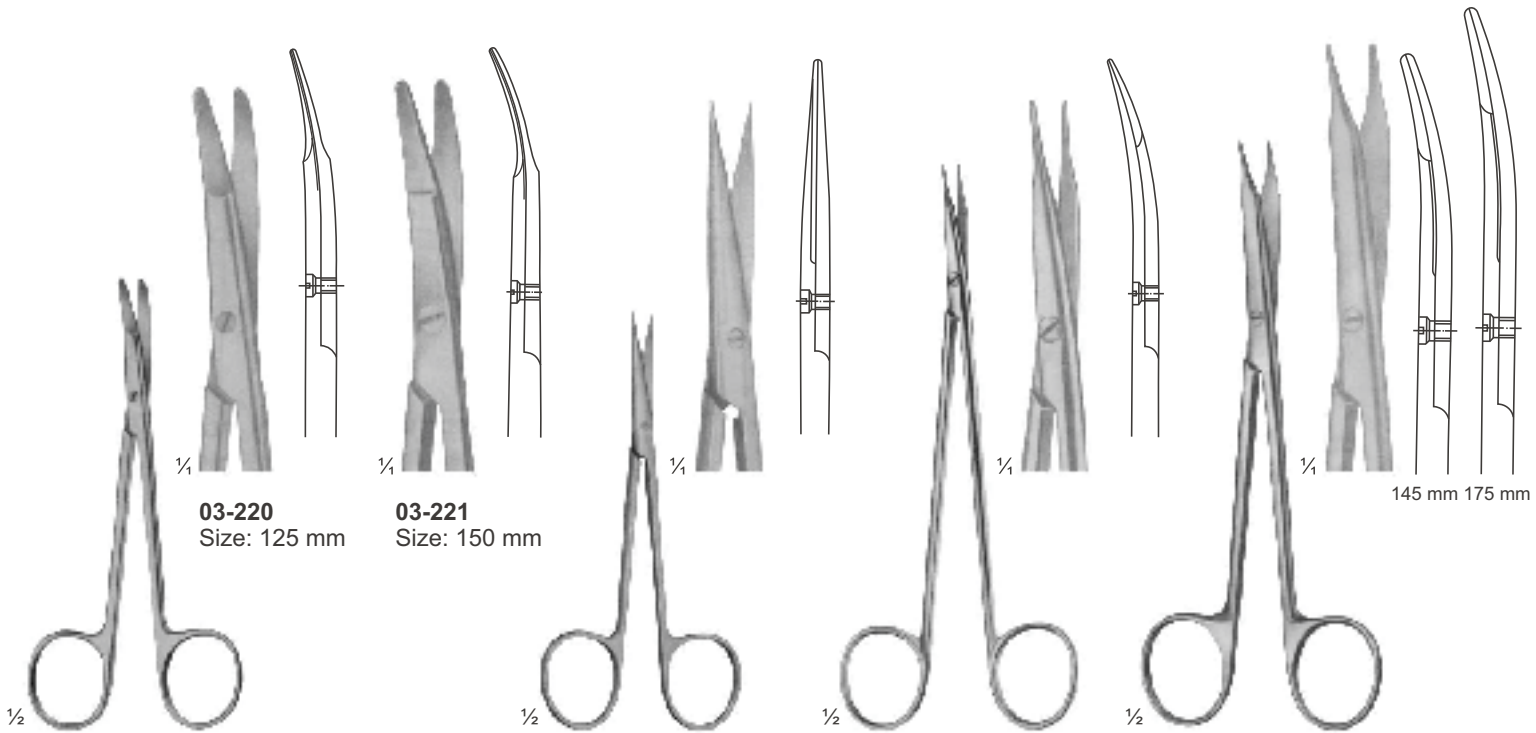

03-220
Size: 125 mm

03-221
Size: 150 mm

¼

¼

¼

¼

¼

¼

¼

145 mm 175 mm

03-220 - 221
KILNER
Special flat points for dissecting
and undermining the skin

03-222
KILNER
Fine dissecting scissors
Size: 115 mm

03-223
JAMESON
Dissecting scissors
Size: 150 mm

03-224
REYNOLDS
Dissecting scissors
Size: 145 - 175 mm

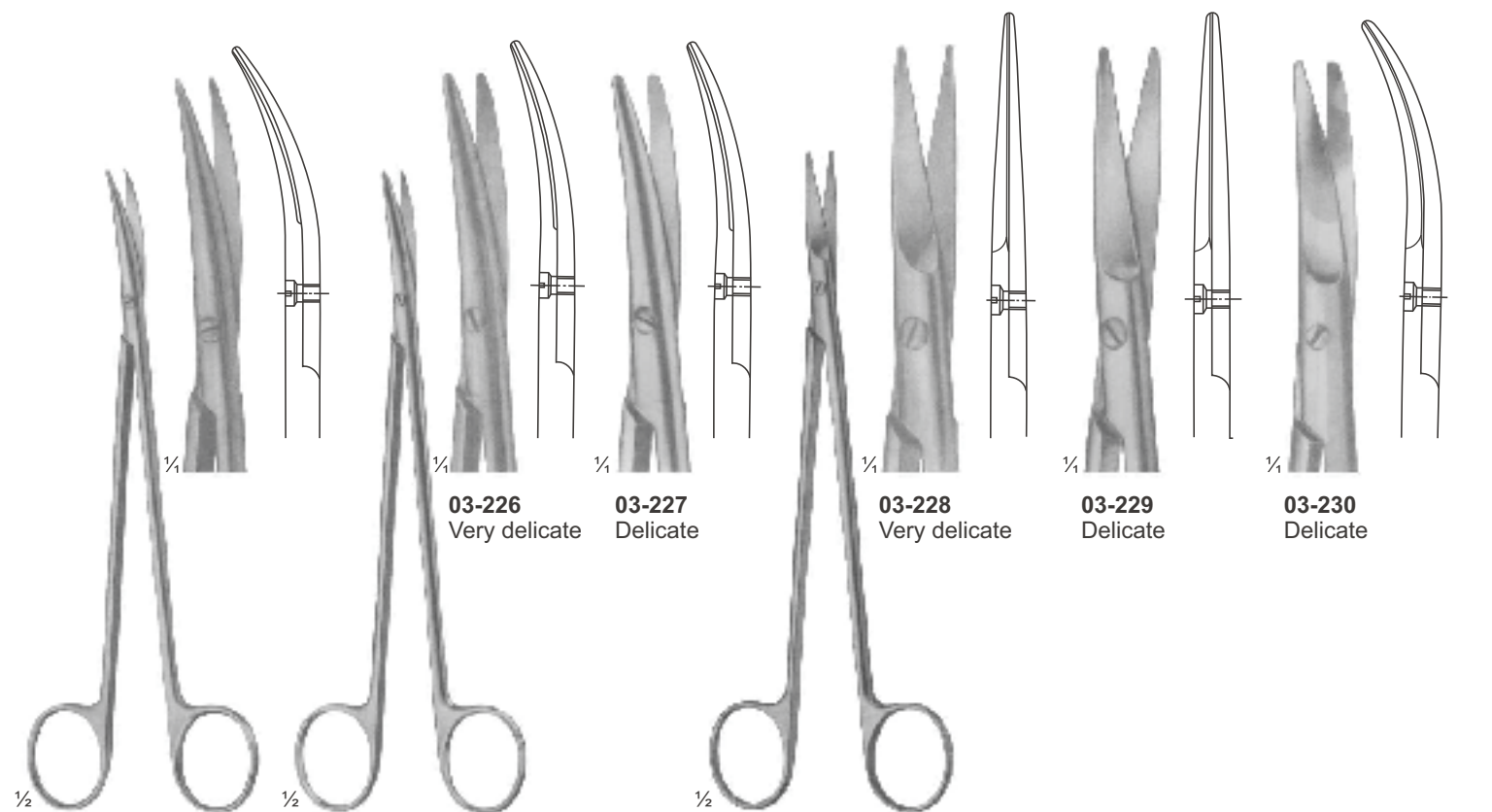

03-226
Very delicate

03-227
Delicate

03-228
Very delicate

03-229
Delicate

03-230
Delicate

03-225
DE BAKEY
Ateriotomy scissors
Size: 175 mm

03-226 - 227
TOENNIS ADSON
Dissecting scissors
Size: 175 mm

03-228 - 230
TOENNIS
Dissecting scissors
Size: 150 mm

Dissecting & Surgical Scissors

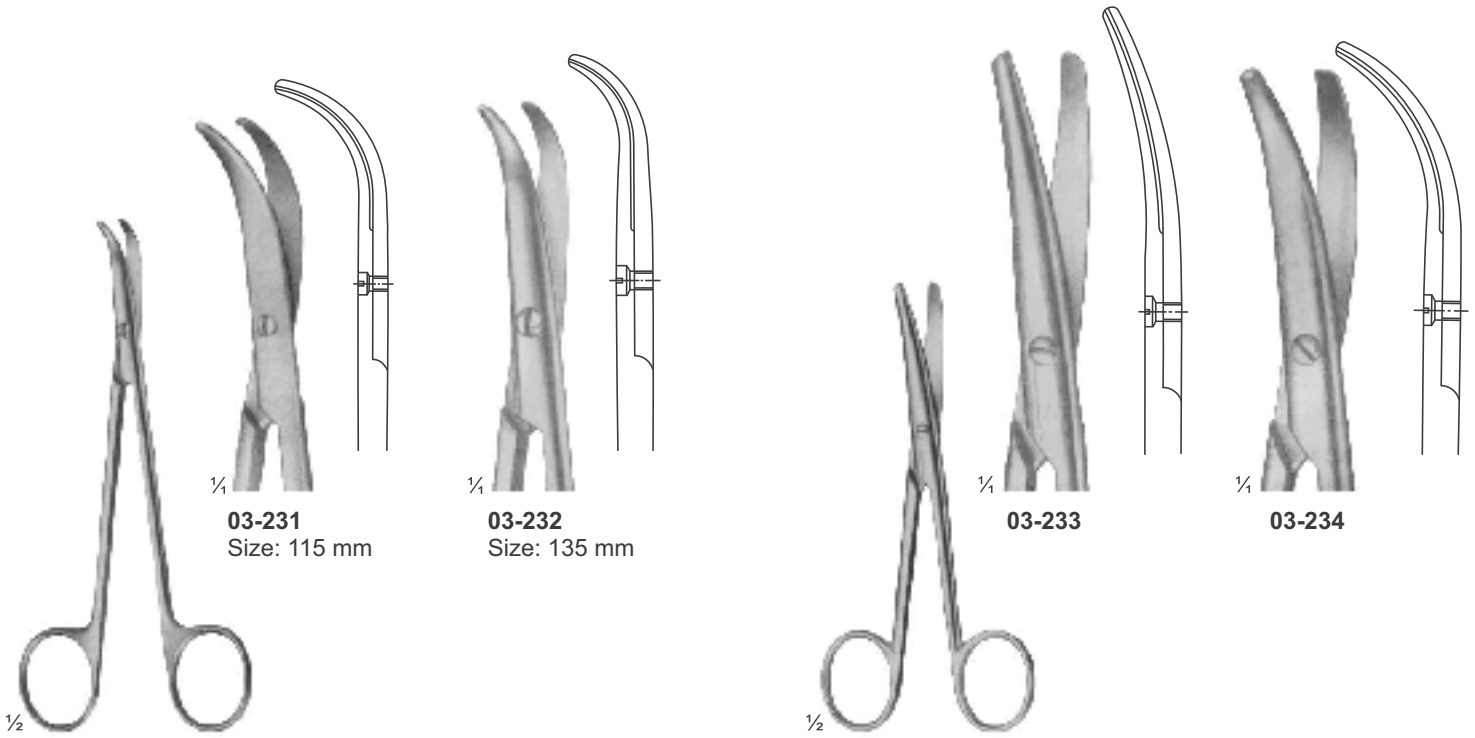

03-231
Size: 115 mm

03-232
Size: 135 mm

03-233

03-234

03-231 - 232
FOMON
Lower lateral scissors

03-233 - 234
LANDOLT
Enucleation scissors
Size: 120 mm

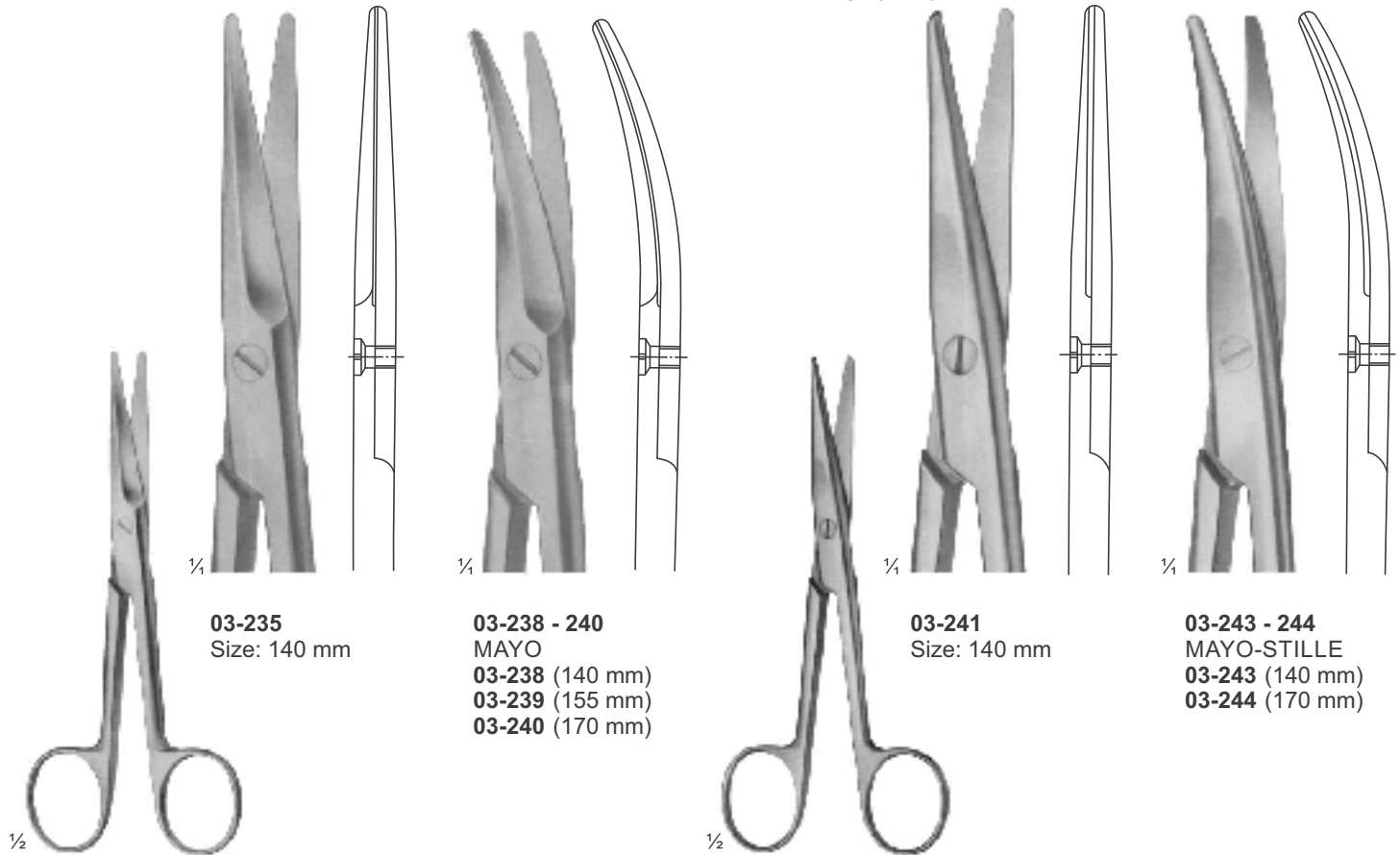

03-235
Size: 140 mm

03-238 - 240
MAYO
03-238 (140 mm)
03-239 (155 mm)
03-240 (170 mm)

03-241
Size: 140 mm

03-243 - 244
MAYO-STILLE
03-243 (140 mm)
03-244 (170 mm)

03-235 - 237
MAYO
03-235 (140 mm)
03-236 (155 mm)
03-237 (170 mm)

03-241 - 242
MAYO-STILLE
03-241 (140 mm)
03-242 (170 mm)

Dissecting Scissors

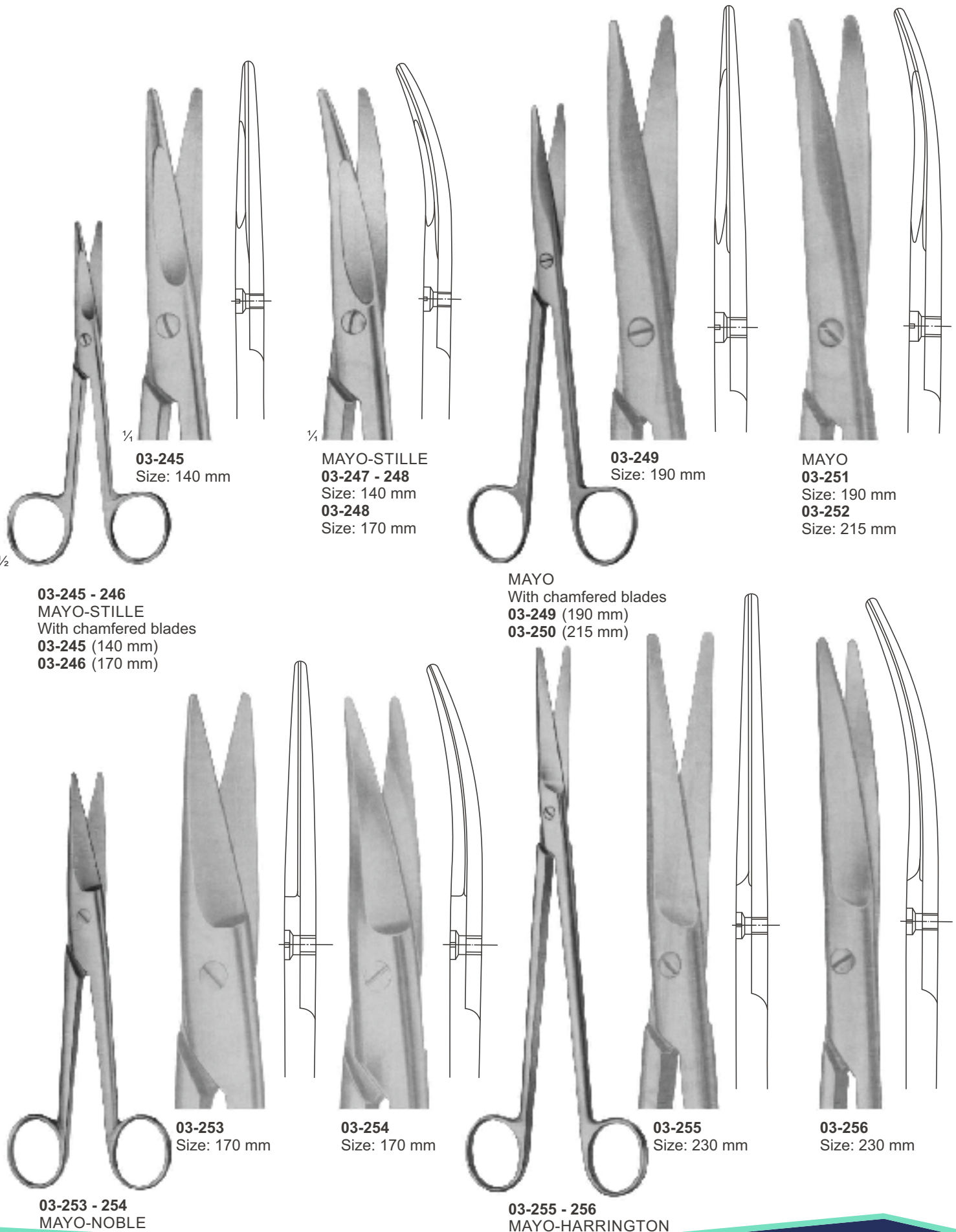

Dissecting Scissors

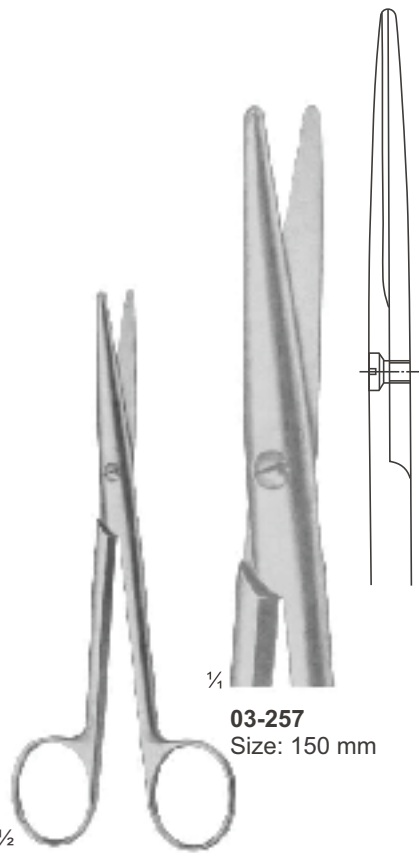

03-257
Size: 150 mm

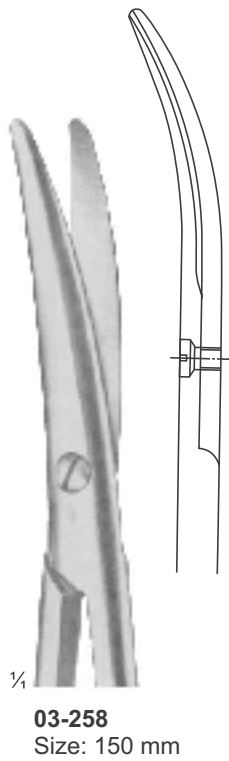

03-258
Size: 150 mm

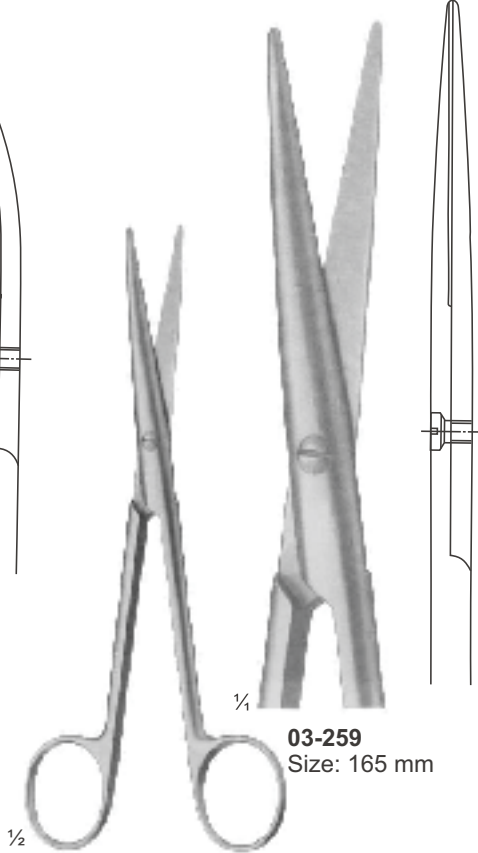

03-259
Size: 165 mm

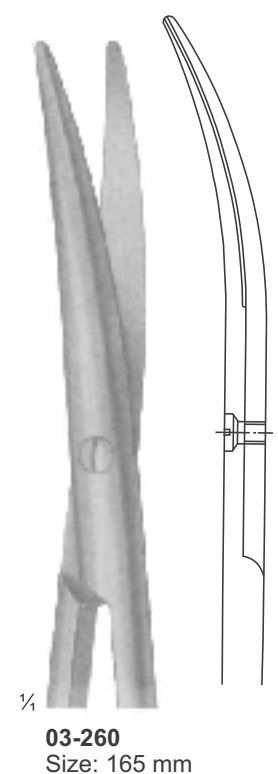

03-260
Size: 165 mm

03-257 - 258
STILLE
Size: 150 mm

03-259 - 260
LEXER
Narrow
Size: 165 mm

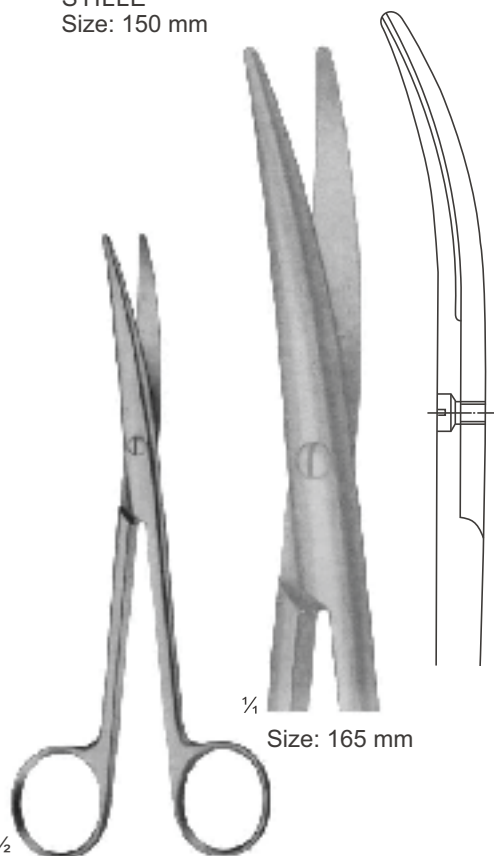

Size: 165 mm

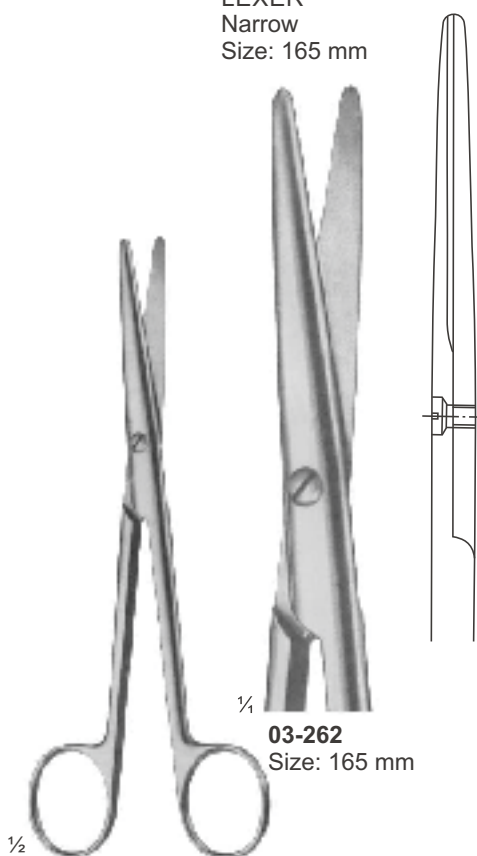

03-262
Size: 165 mm

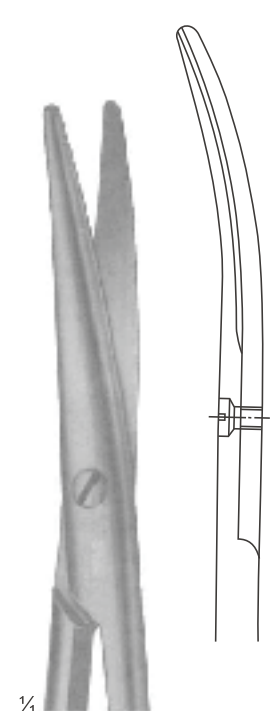

MAYO
03-264 - 266
Size: 165 mm

03-261
MAYO-LEXER
Standard

03-262 - 263
MAYO
03-262 (165 mm)
03-263 (200 mm)

03-265
Size: 200 mm
03-266
Size: 210 mm

Dissecting Scissors

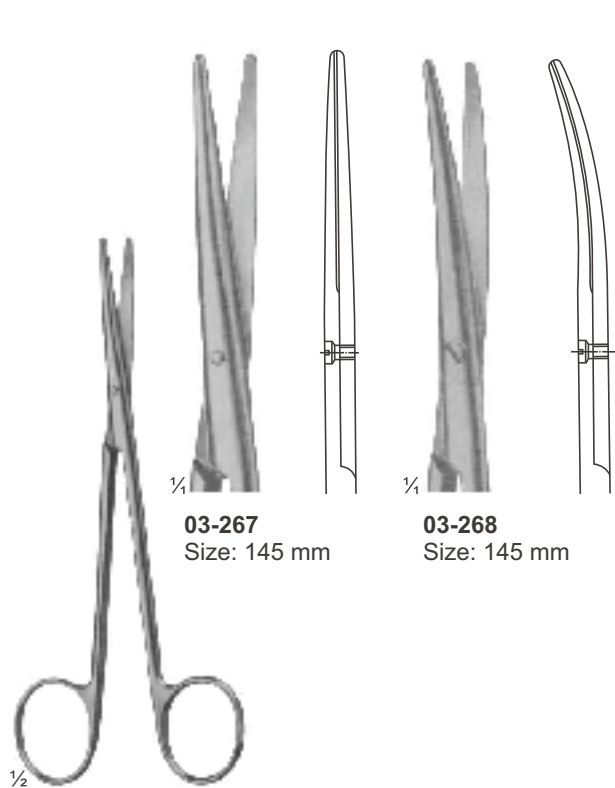

03-267
Size: 145 mm

03-268
Size: 145 mm

03-267 - 268
BABY - METZENBAUM

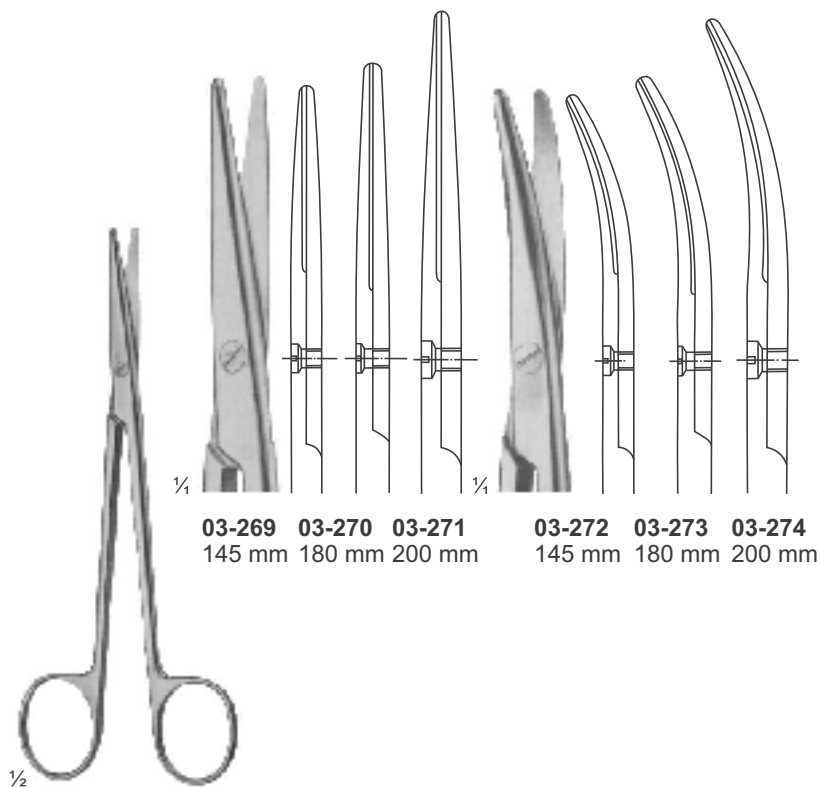

03-269 145 mm

03-270 180 mm

03-271 200 mm

03-272 145 mm

03-273 180 mm

03-274 200 mm

03-269 - 274
METZENBAUM



03-275 - 282

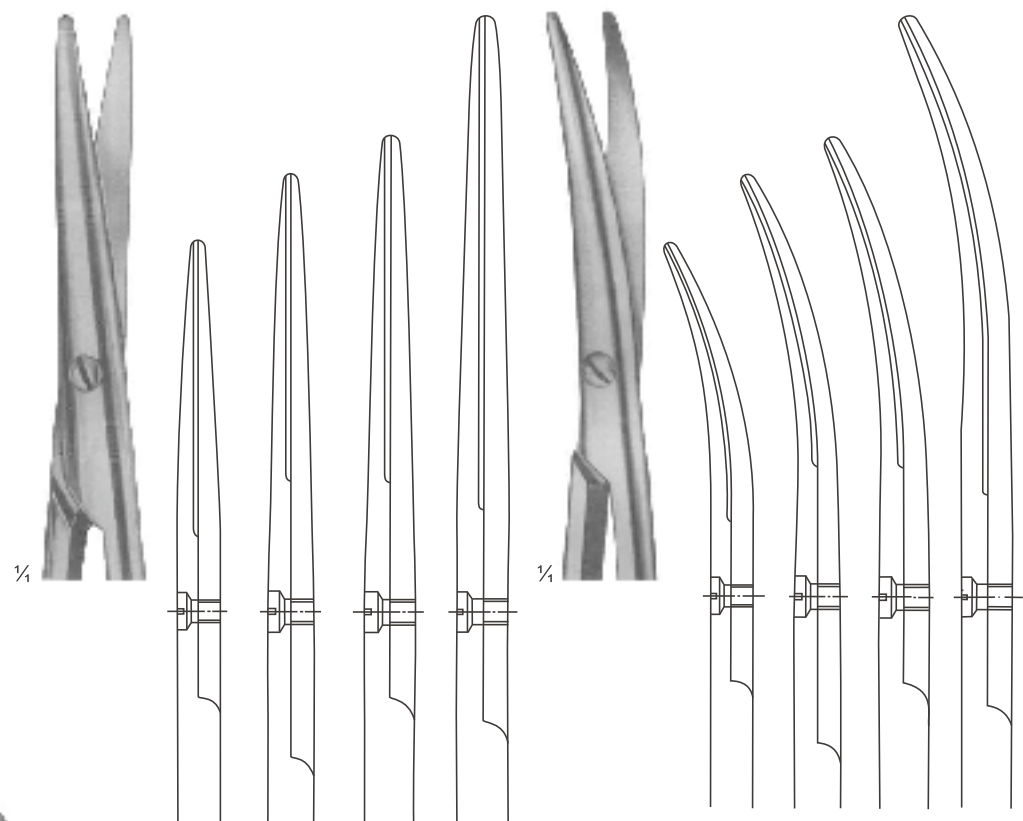

03-275 230 mm

03-276 250 mm

03-277 280 mm

03-278 305 mm

03-279 230 mm

03-280 250 mm

03-281 280 mm

03-282 305 mm

Vessel Scissors

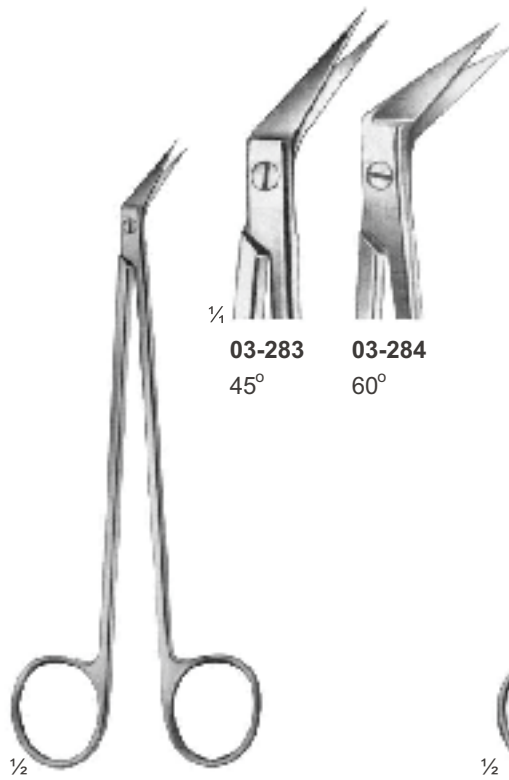

03-283 - 284
DE BAKY
Size: 155 mm

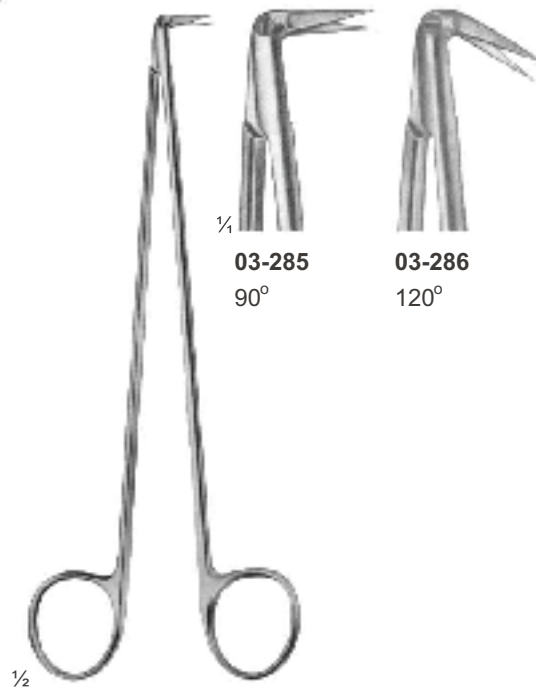

03-285 - 286
DIETRICH
Size: 170 mm

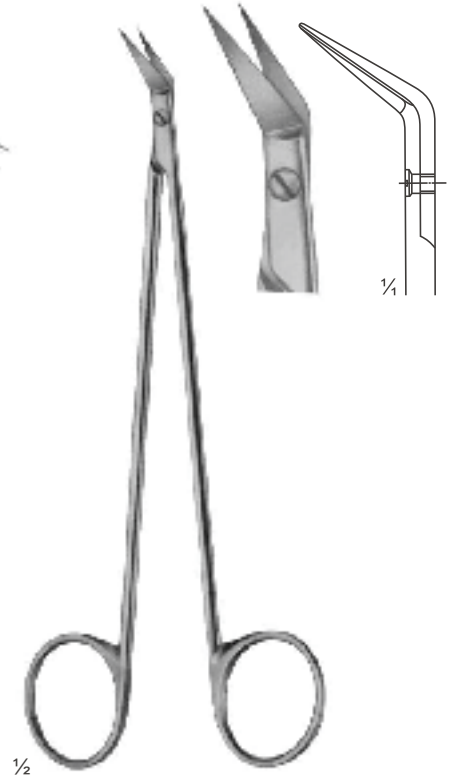

03-287
POTTS-SMITH
Size: 180 mm

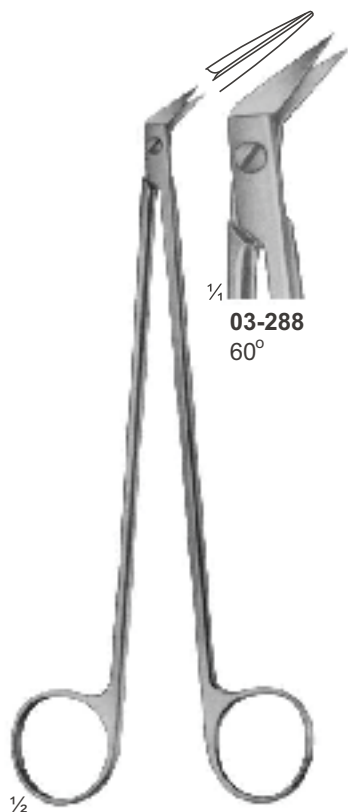

03-288
POTTS-SMITH
Size: 180 mm

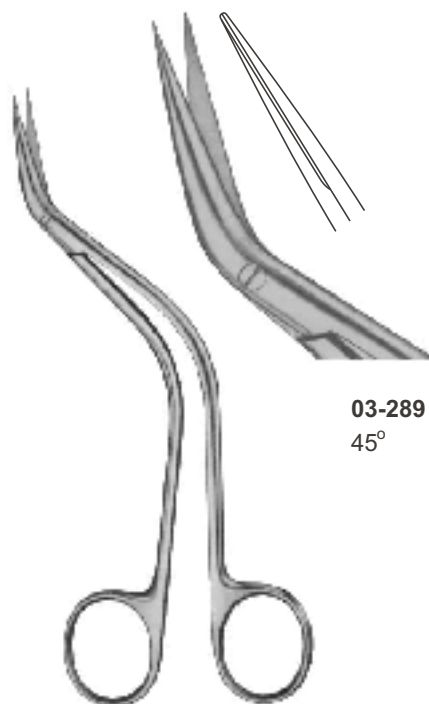

03-289
DEBAKEY
Size: 155 mm

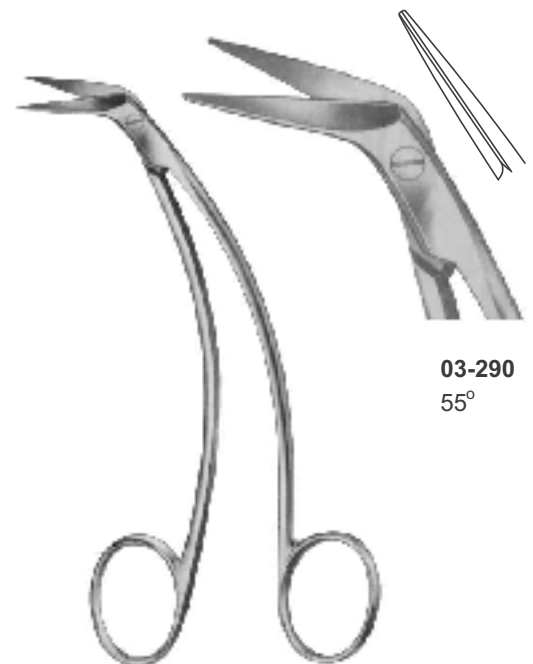

03-290
FAVOLORO
Size: 140 mm

Cardiovascular and Neuro-Surgery Scissors

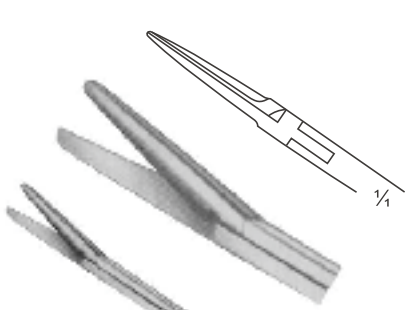

03-291
OLIVECRONA
Dura Scissors

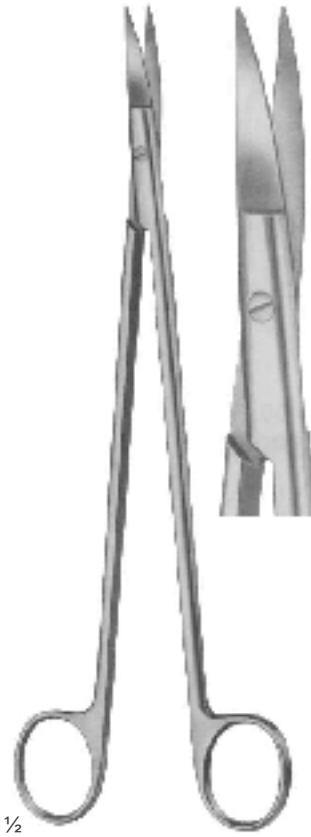

03-292
STRULLY
Pointed
Size: 220 mm

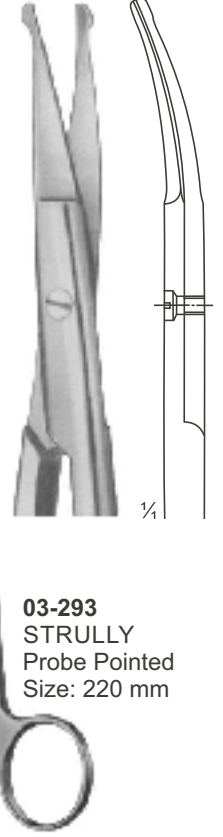

03-293
STRULLY
Probe Pointed
Size: 220 mm

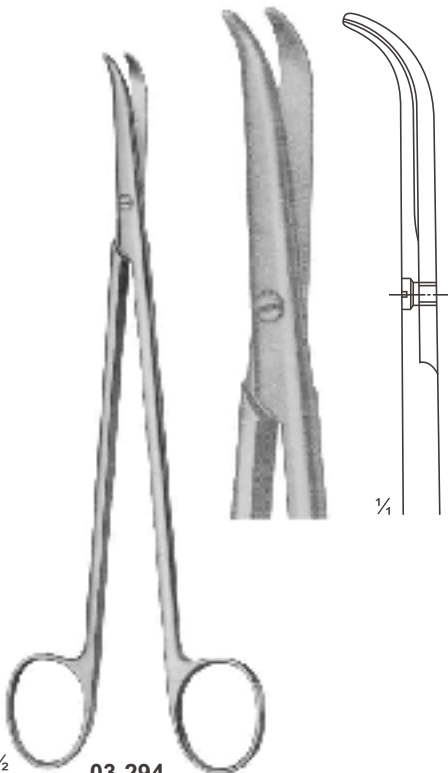

03-294
THOREK

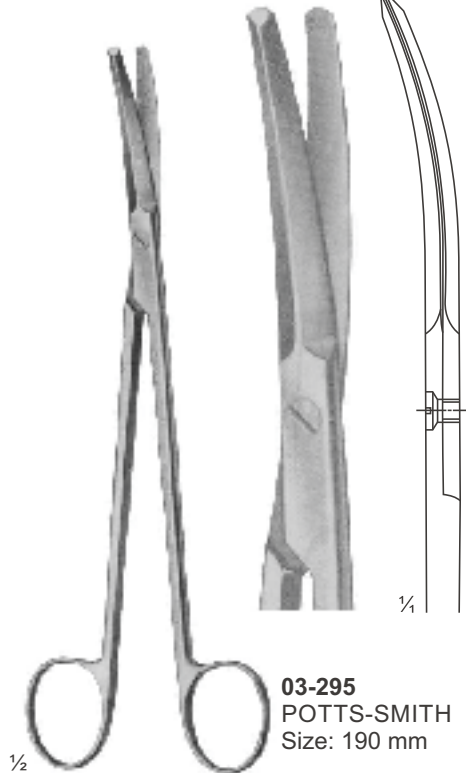

03-295
POTTS-SMITH
Size: 190 mm

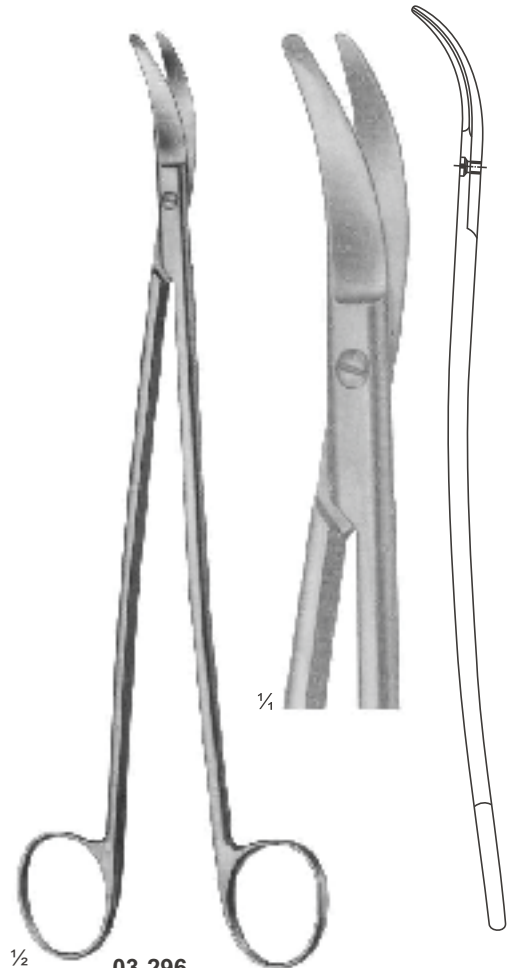

03-296
SATINSKY

Delicate, Nasal and Tonsil Scissors

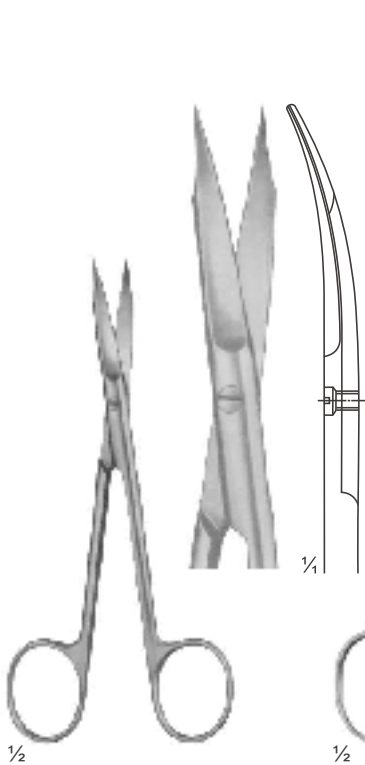

03-297
1 Finlay Toothed Blade
Size: 130 mm

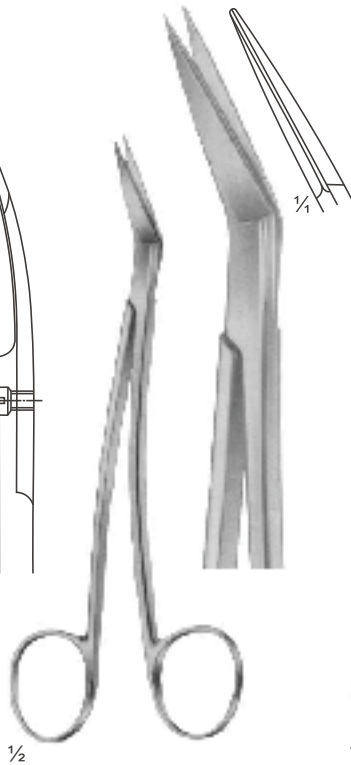

03-298
LOCKLIN
Curved Sideways,
1 Toothed Blade
Size: 155 mm

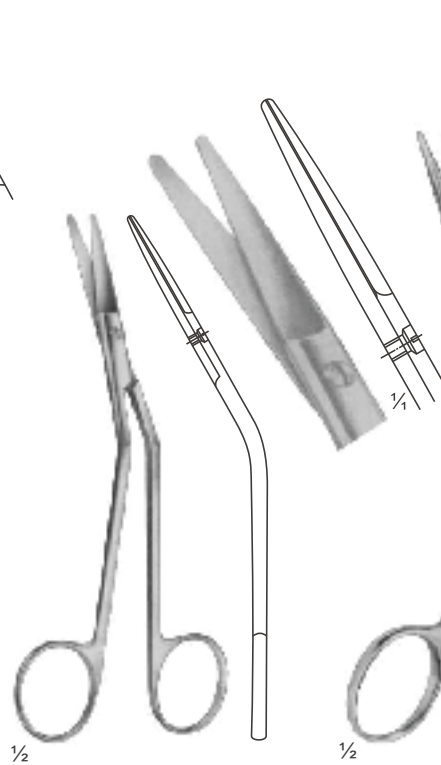

03-299
FOMON
Blades Serrated
Size: 145 mm

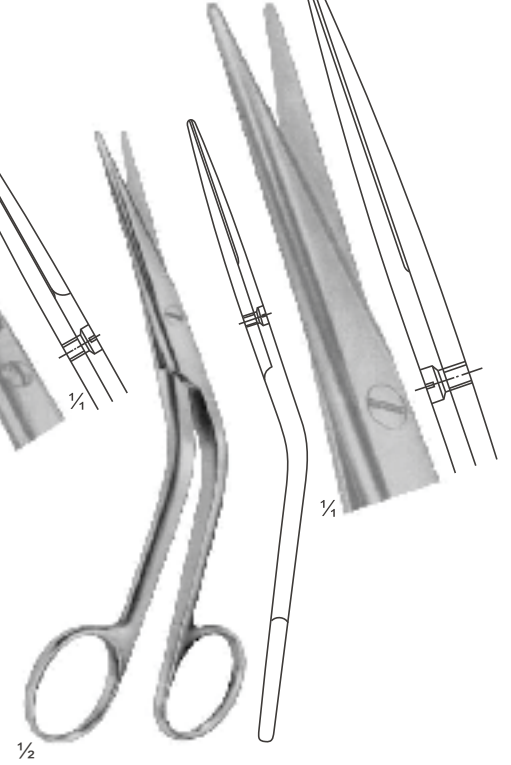

03-300
COTTLE
Size: 165 mm

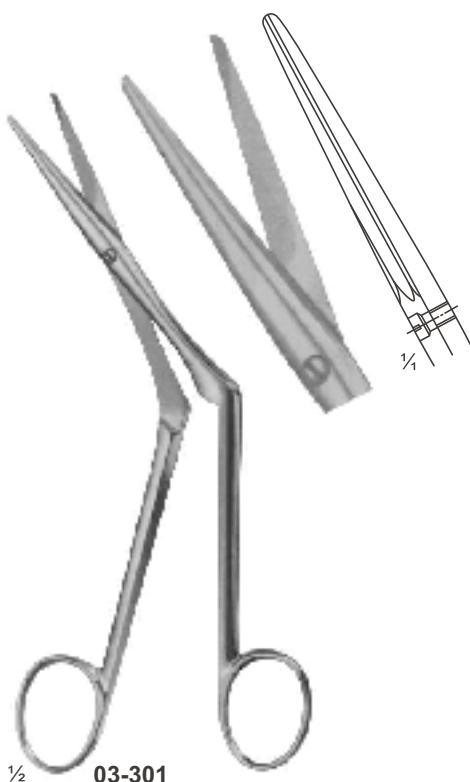

03-301
HEYMANN-KNIGHT

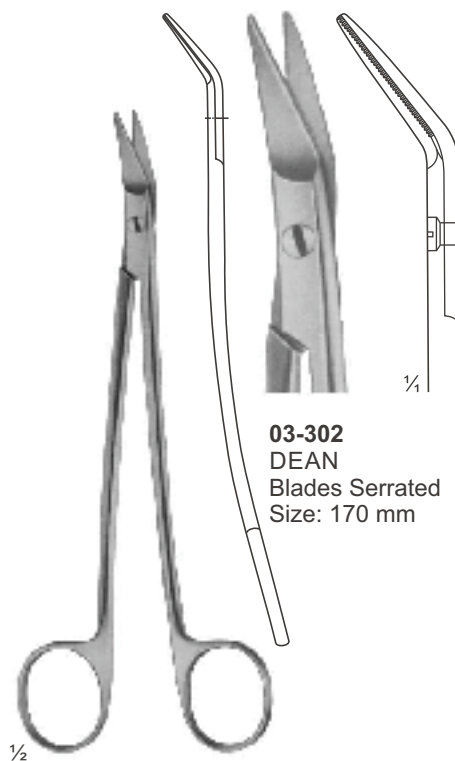

03-302
DEAN
Blades Serrated
Size: 170 mm

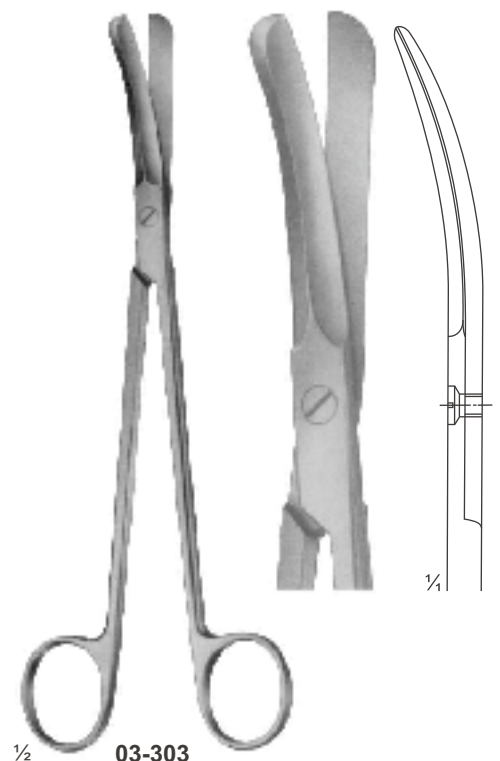

03-303
GOOD

Bone Shears

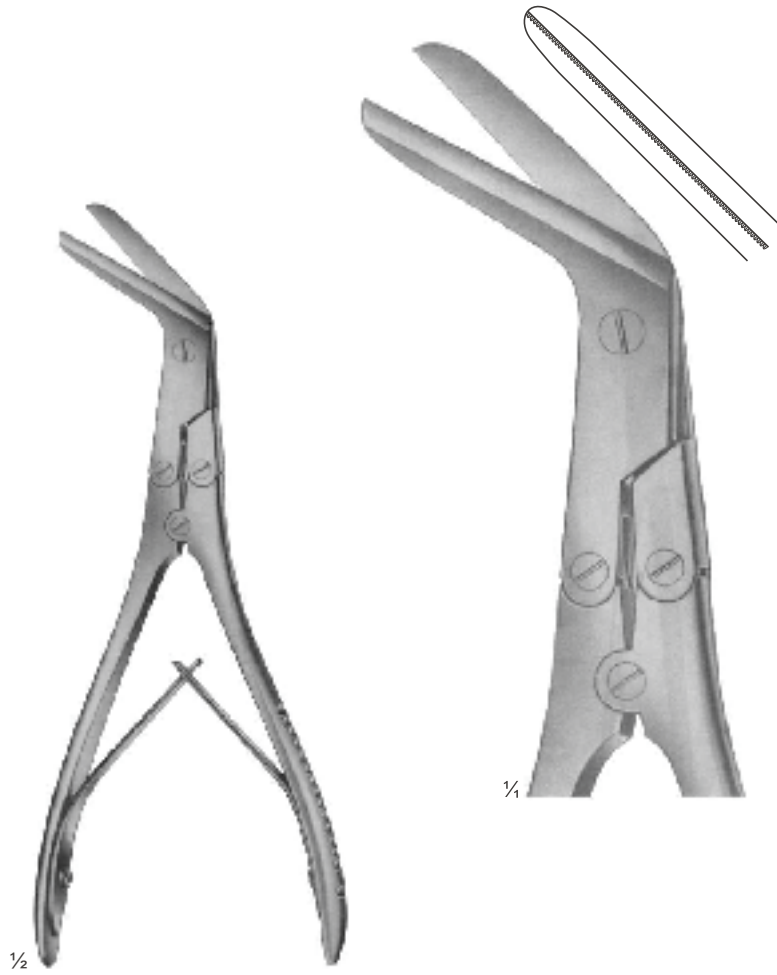

03-304
KILLIAN
Size: 200 mm

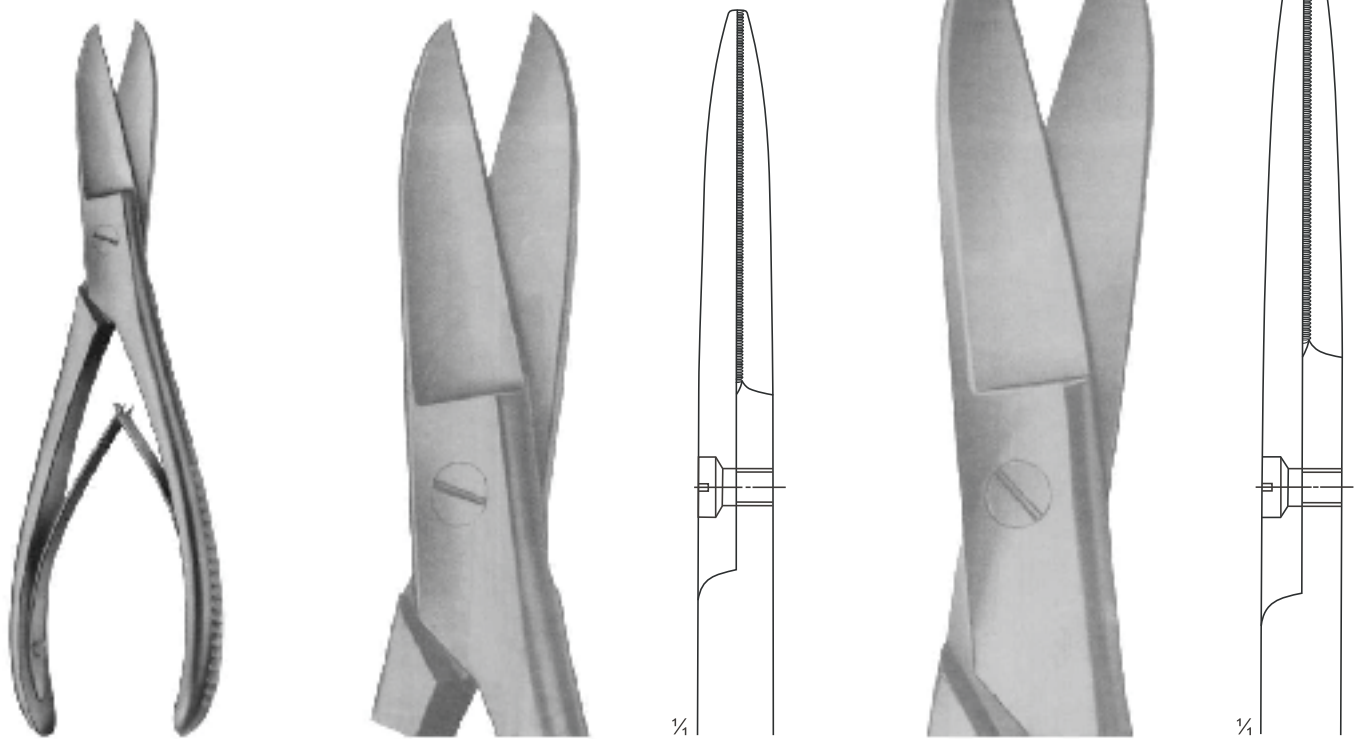

03-305 - 306

03-305
195 mm

03-306

Operating and Gynaecology Scissors

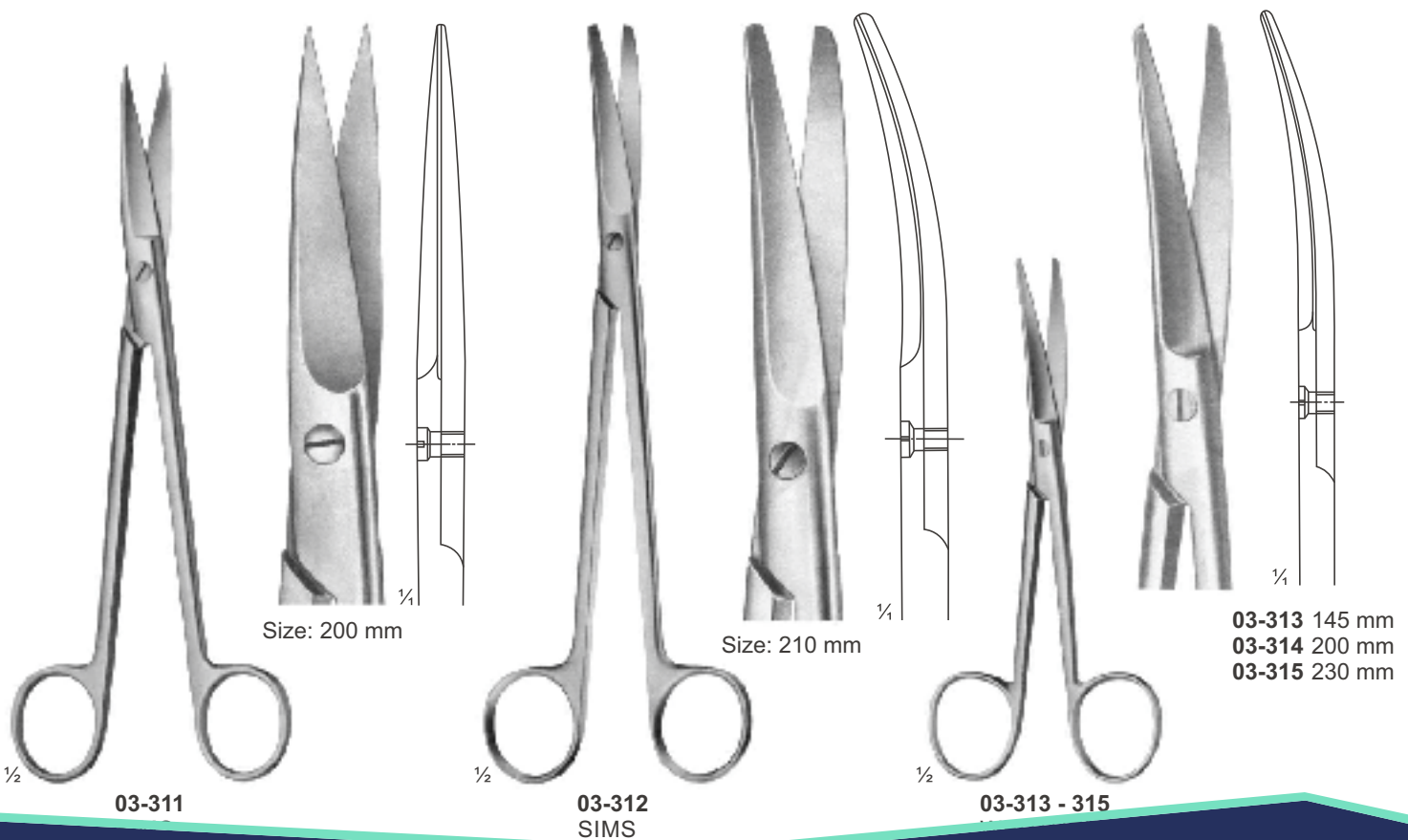
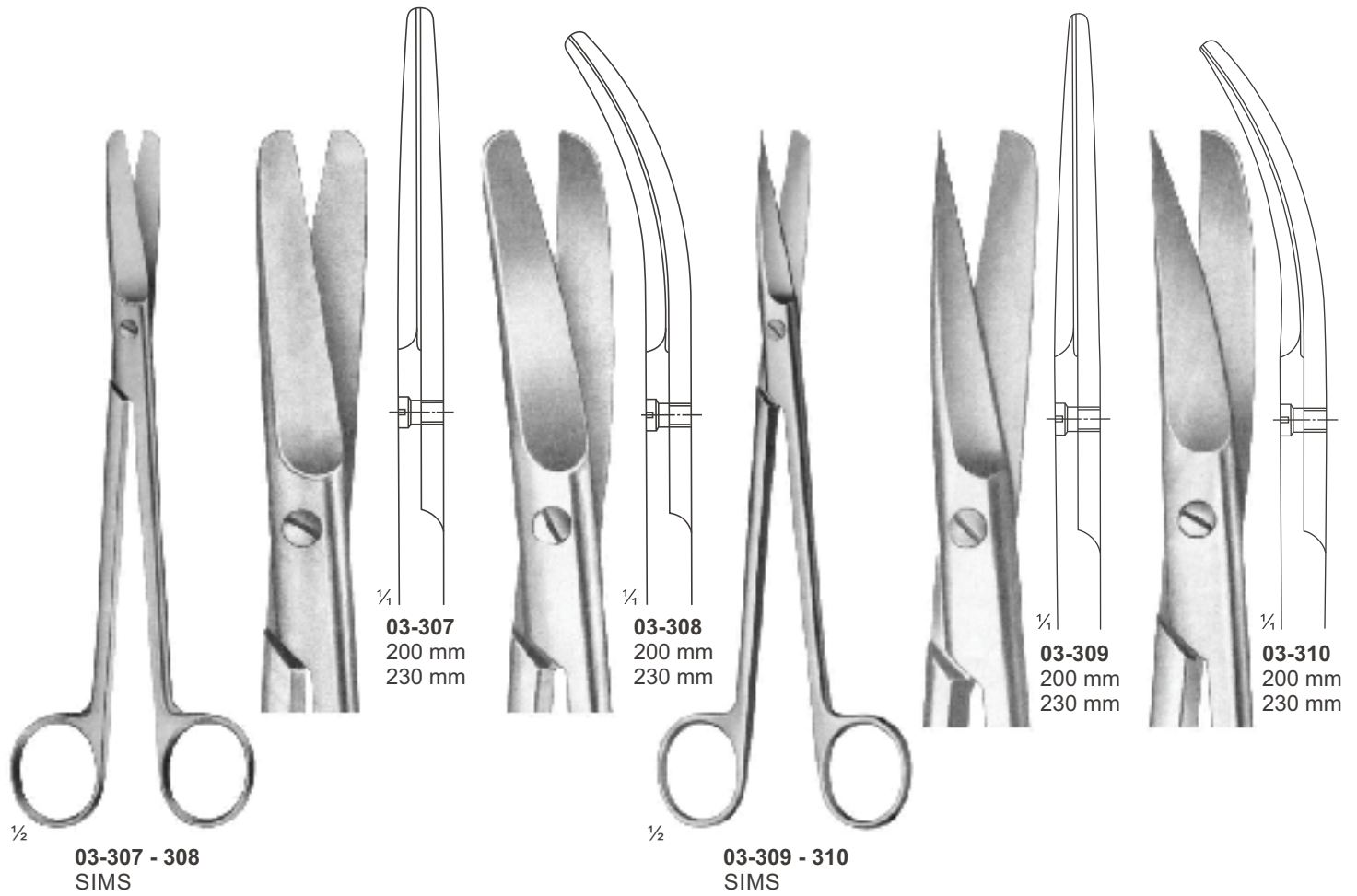

Operating and Gynaecology Scissors



03-316
SIEBOLD
Uterine Scissors
Size: 245 mm

03-317
BOZEMANN
Uterine Scissors
Size: 220 mm

03-318
SIMS-SIEBOLD
Uterine Scissors
Size: 250 mm

Operating and Gynaecology Scissors

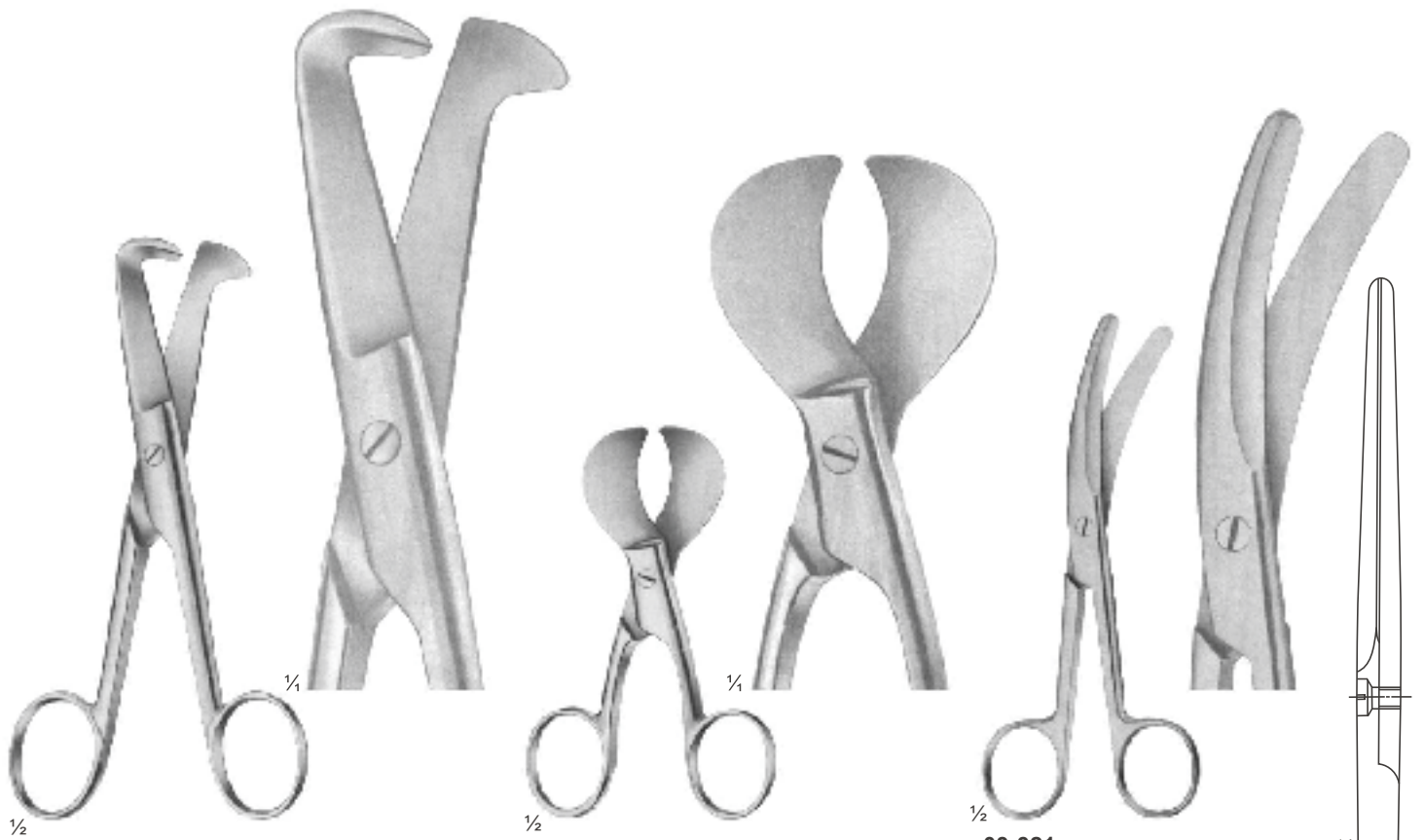

03-319
SCHUMACHER
Umbilical Cord Scissors
Size: 155 mm

03-320
Umbilical Cord Scissors
Size: 105 mm

03-321
Umbilical Cord Scissors

135 mm

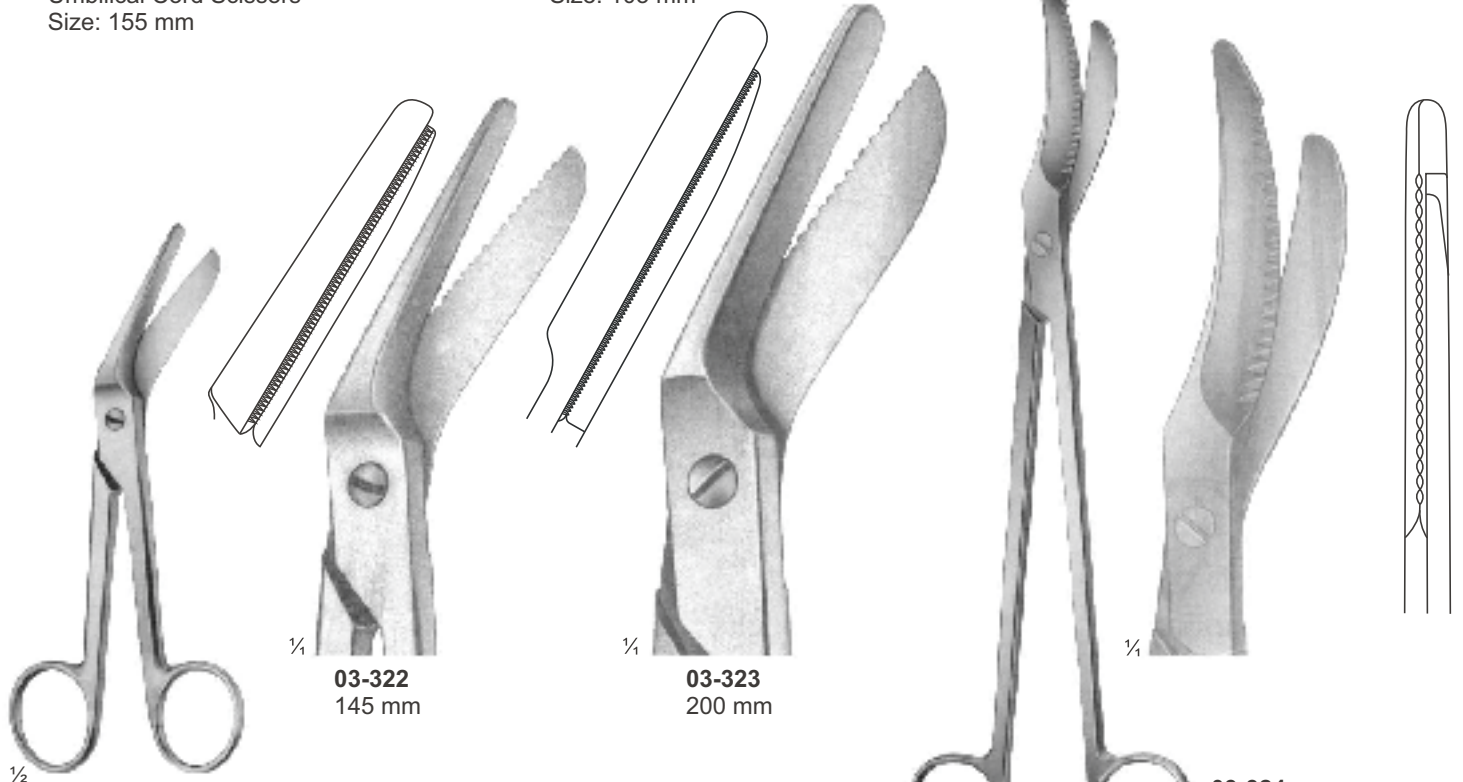

03-322 - 323
BRAUN-STADLER
Empisiotomy Scissors

03-322
145 mm

03-323
200 mm

03-324
DAMMSCHERE
Empisiotomy Scissors
240 mm

Bowel Scissors, Cartilage Scissors

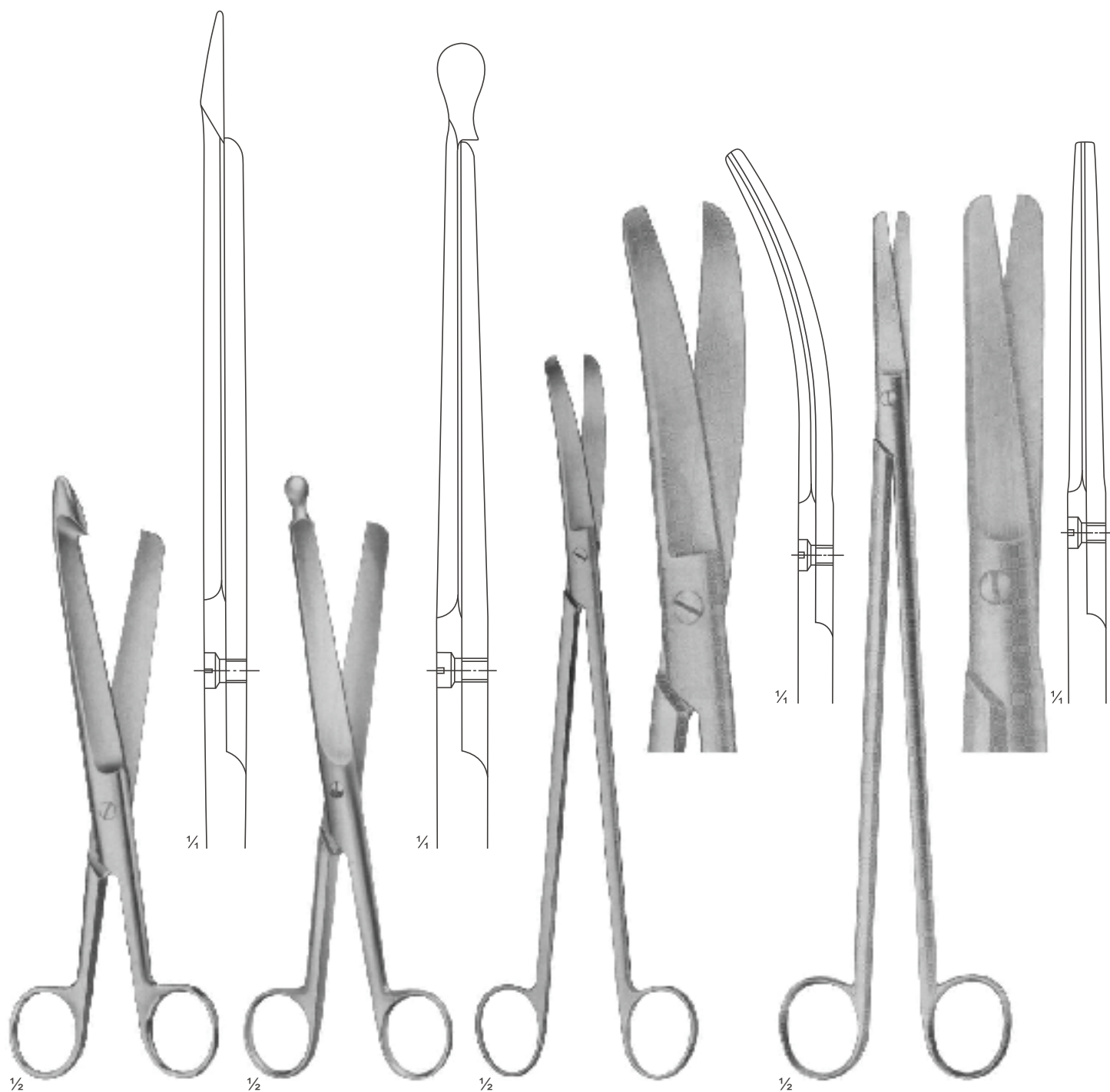

03-325
DAMMSCHERE
Bowel Scissors
Size: 210 mm

03-326
DAMMSCHERE
Bowel Scissors
Size: 210 mm

03-327
LLOYD-DAVIES
(GOLIGHER'S)
Rectal Scissors
Size: 255 mm

03-328
STELZNER
Rectal Scissors
Size: 310 mm

Ligature Scissors

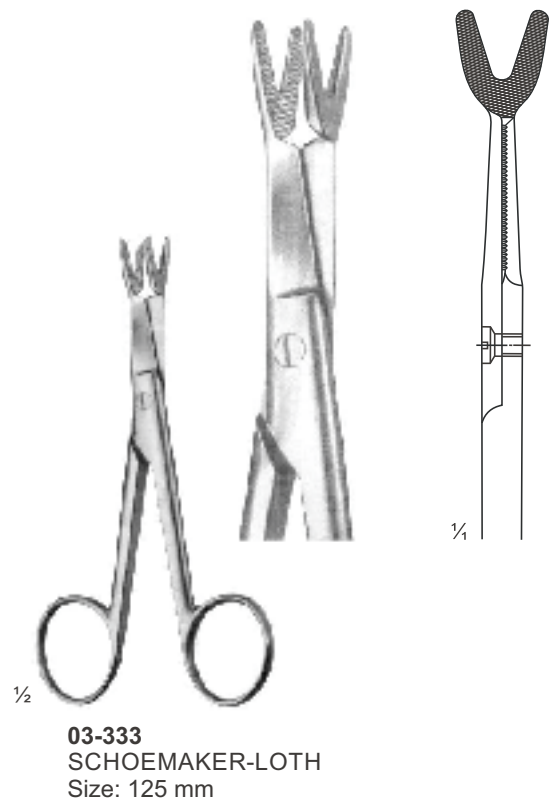
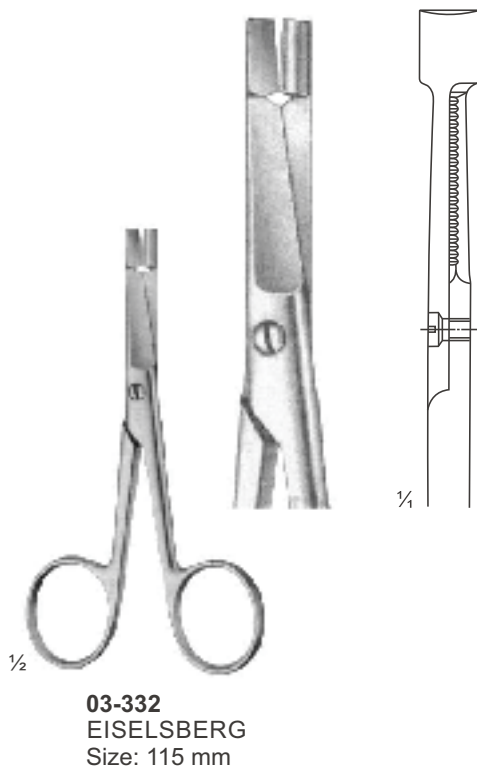
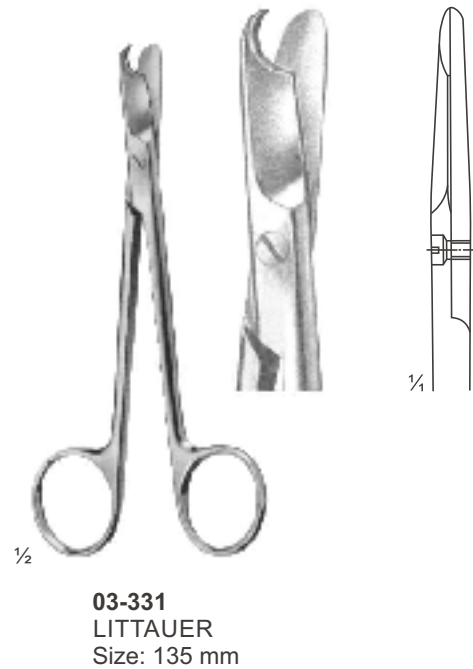
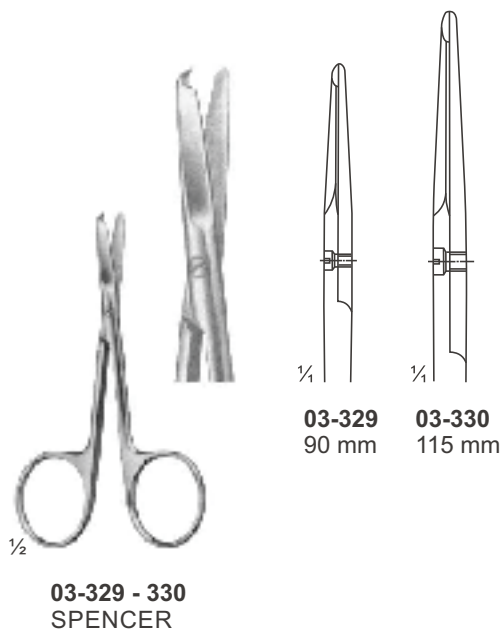

Wire and Plate Scissors



03-334 - 338
BEEBE
Size: 110 mm

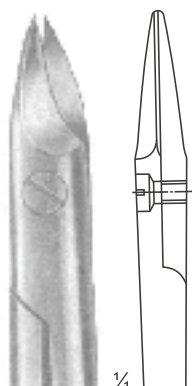

03-334

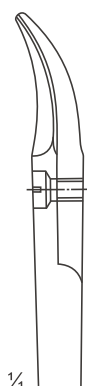

03-335

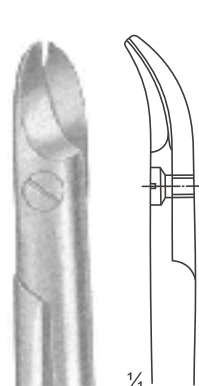

03-336
Broad Blades

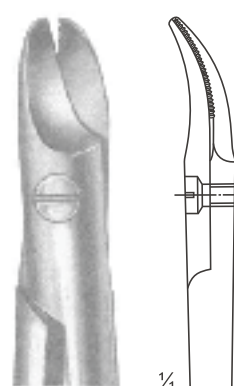

03-337
1 Blade Serrated

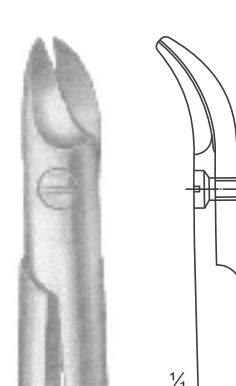

03-338
NAUJOKS
Strongly Curved

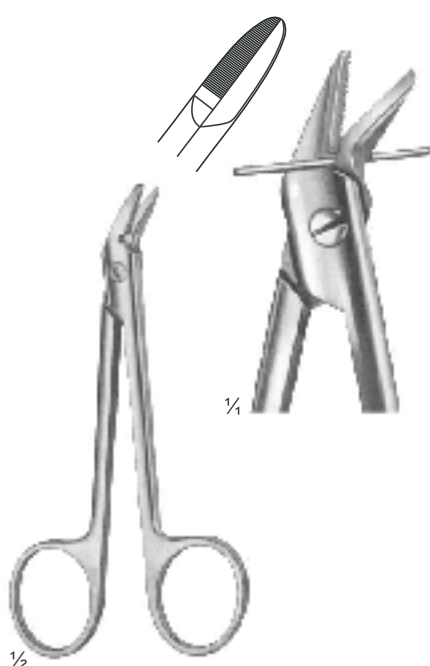

03-339
1 Blade Serrated
Size: 120 mm

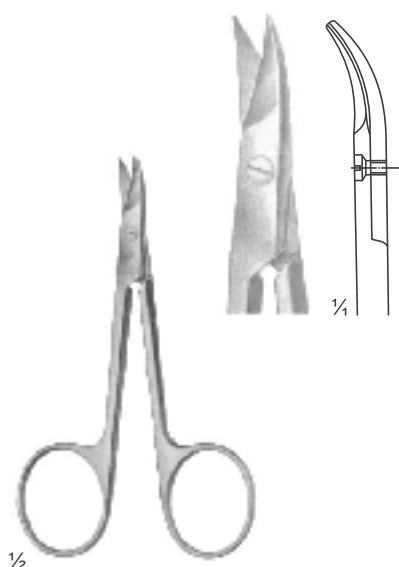

03-340
STRACK
Size: 100 mm

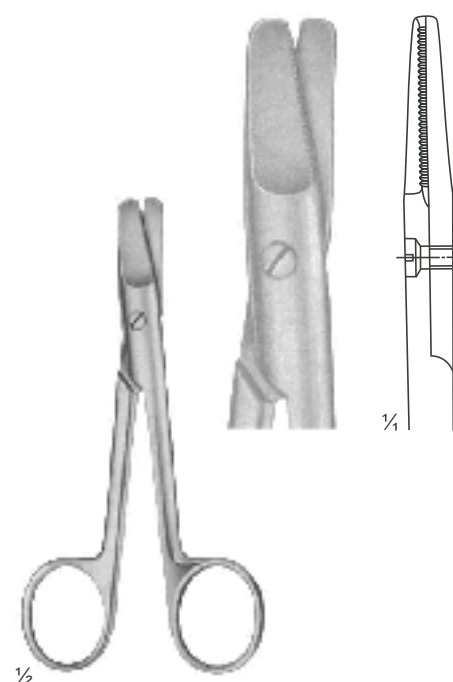

03-341
HARVEY
Size: 125 mm

Wire and Plate Scissors

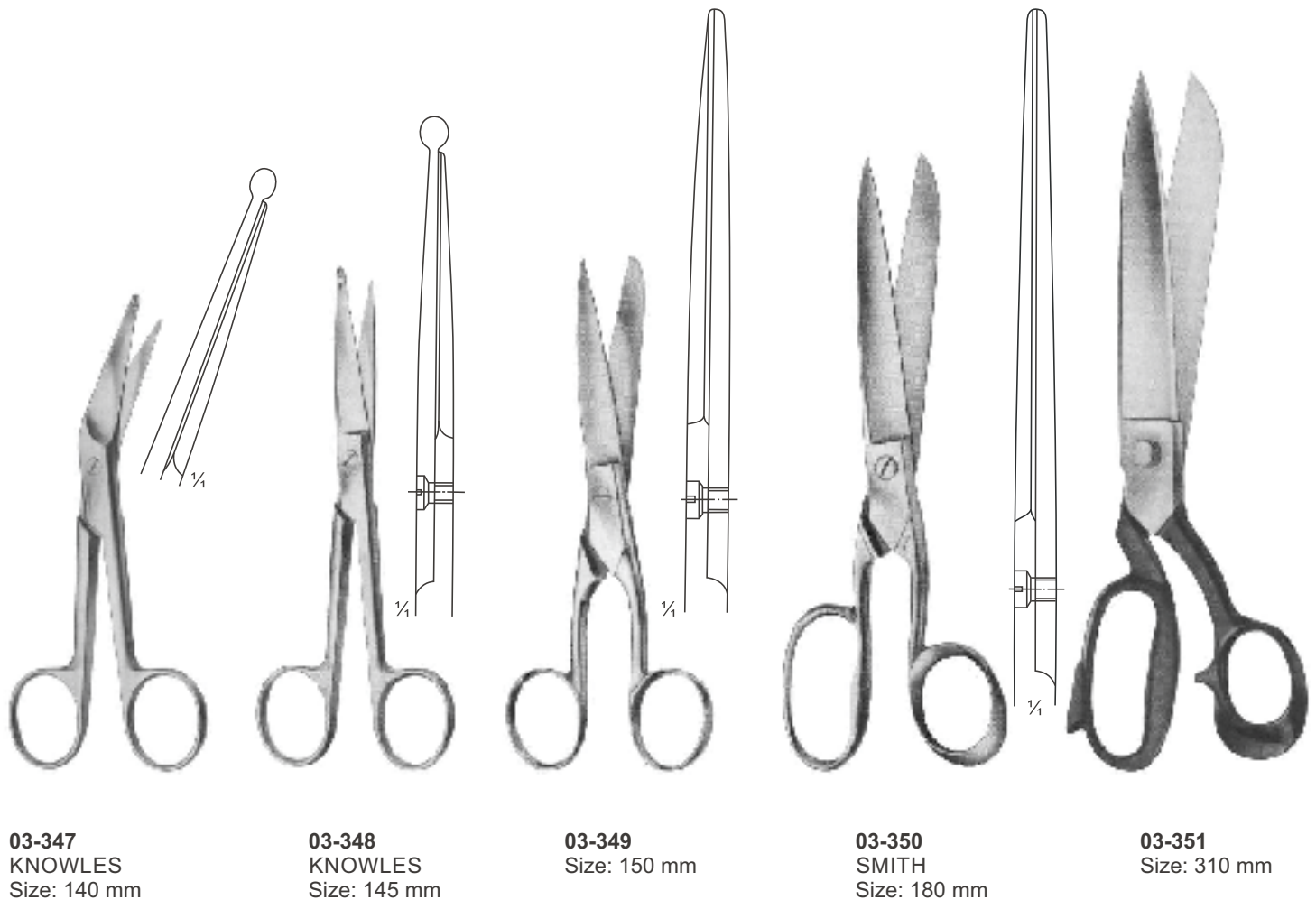
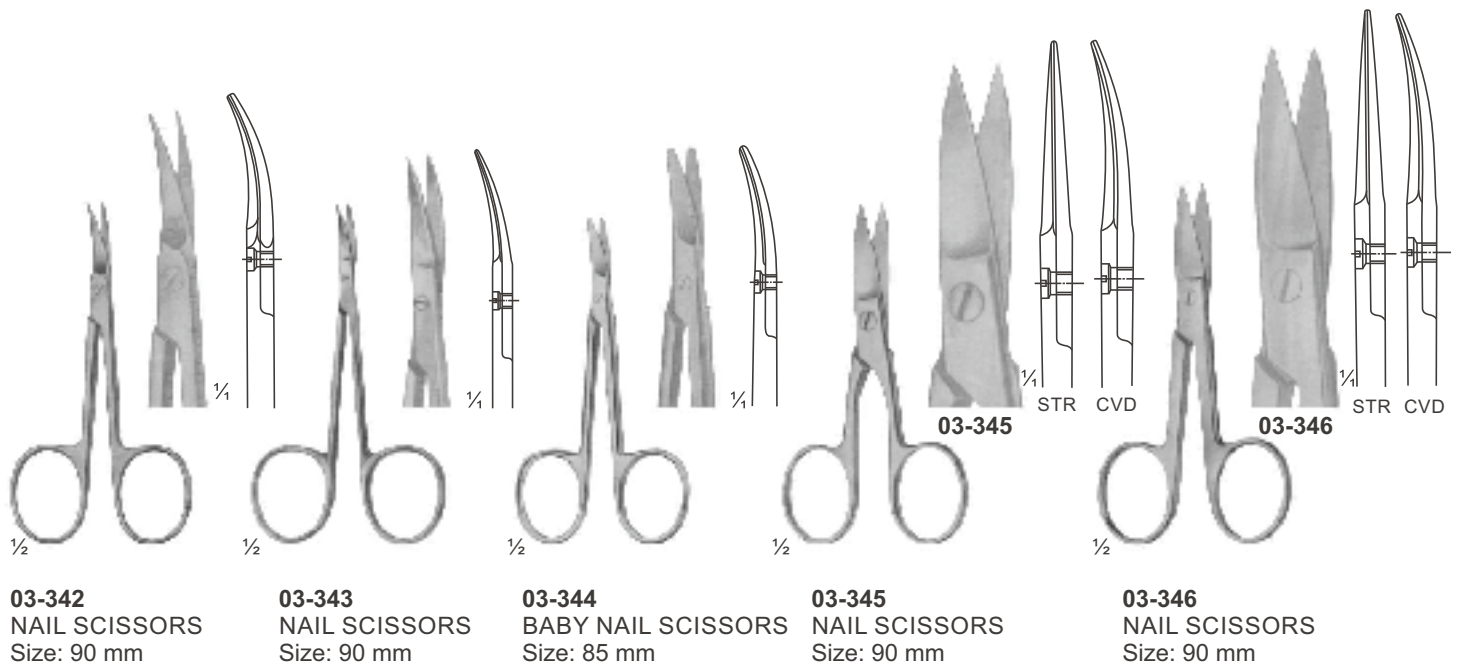

Bandage and Cloth Scissors



03-352
UNIVERSAL AND BANDAGE SCISSORS
180 mm

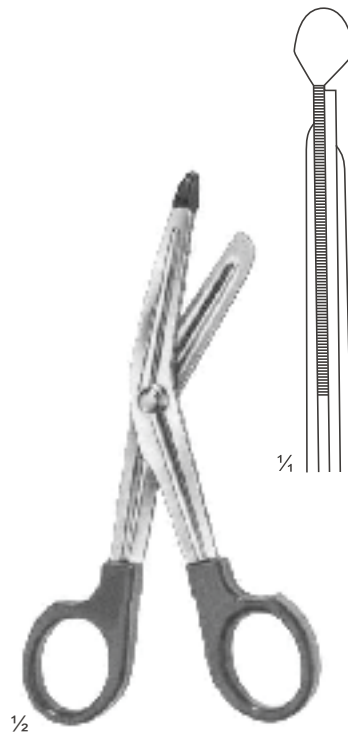

03-353
LISTER
Size: 145 mm

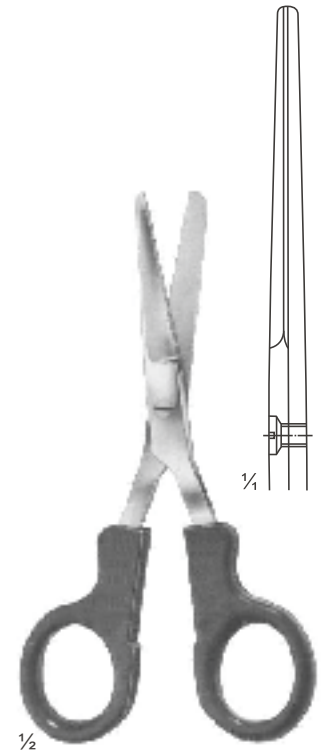

03-354
LISTER
Size: 145 mm

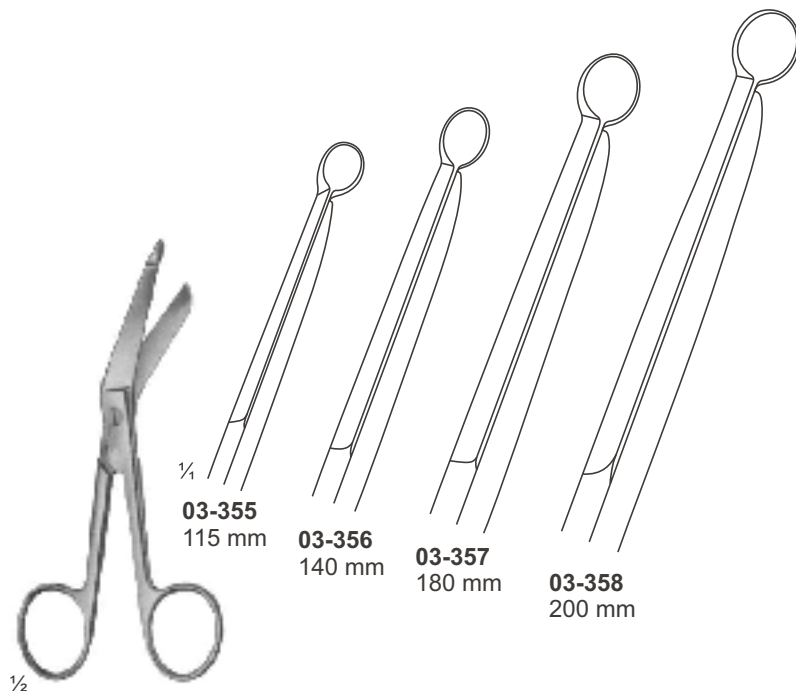

03-355 - 358
LISTER

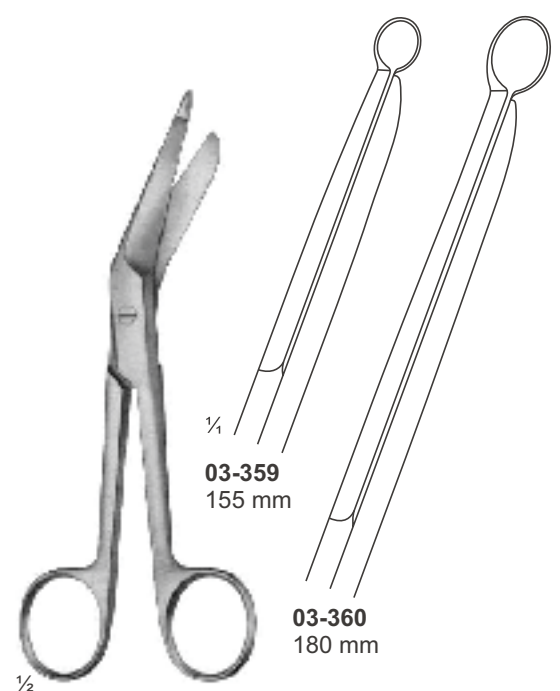

03-359 - 360
LISTER

Bandage, Cloth and Plaster Scissors

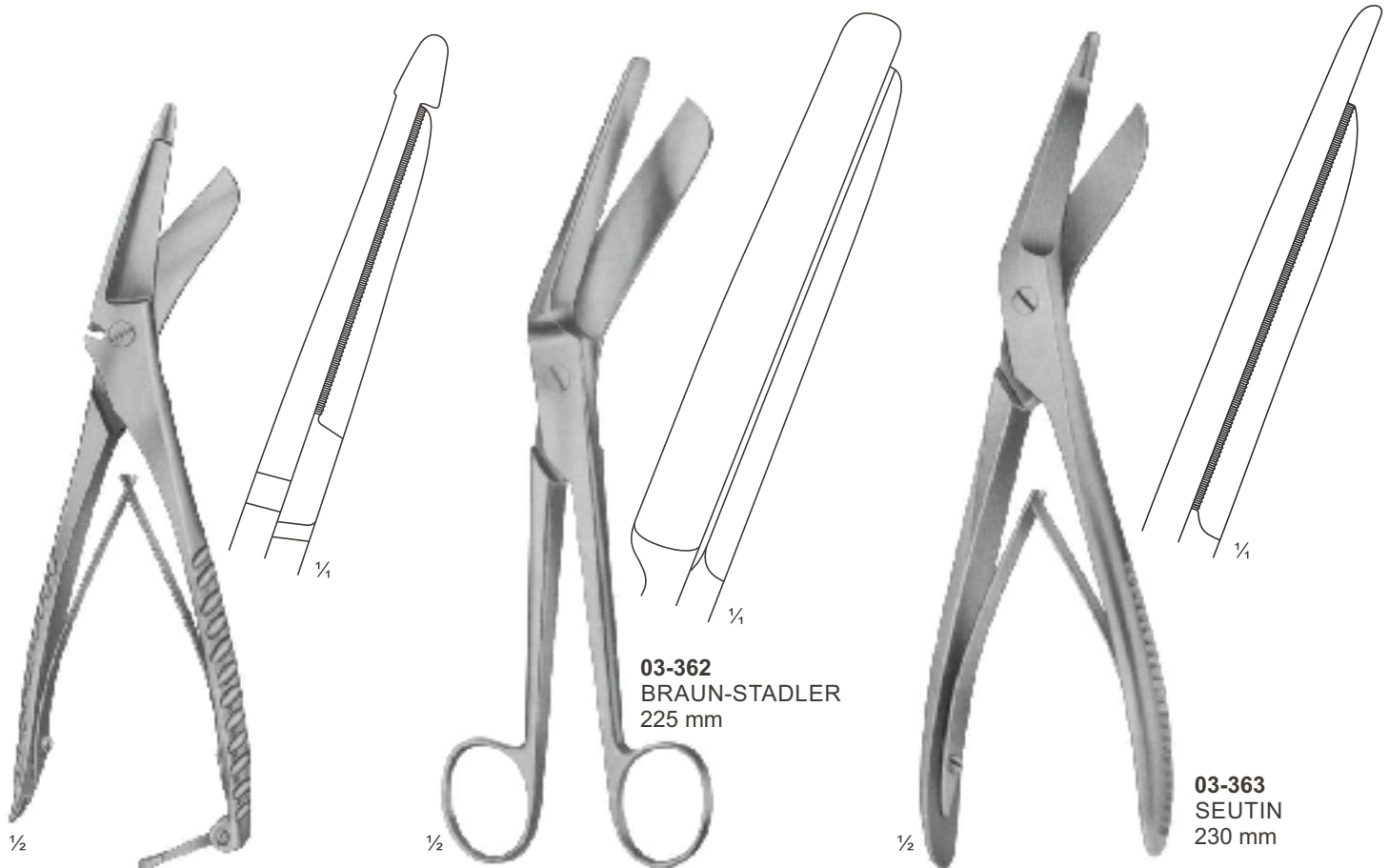

03-361
CLOTH SCISSORS
205 mm

03-362
BRAUN-STADLER
225 mm

03-363
SEUTIN
230 mm

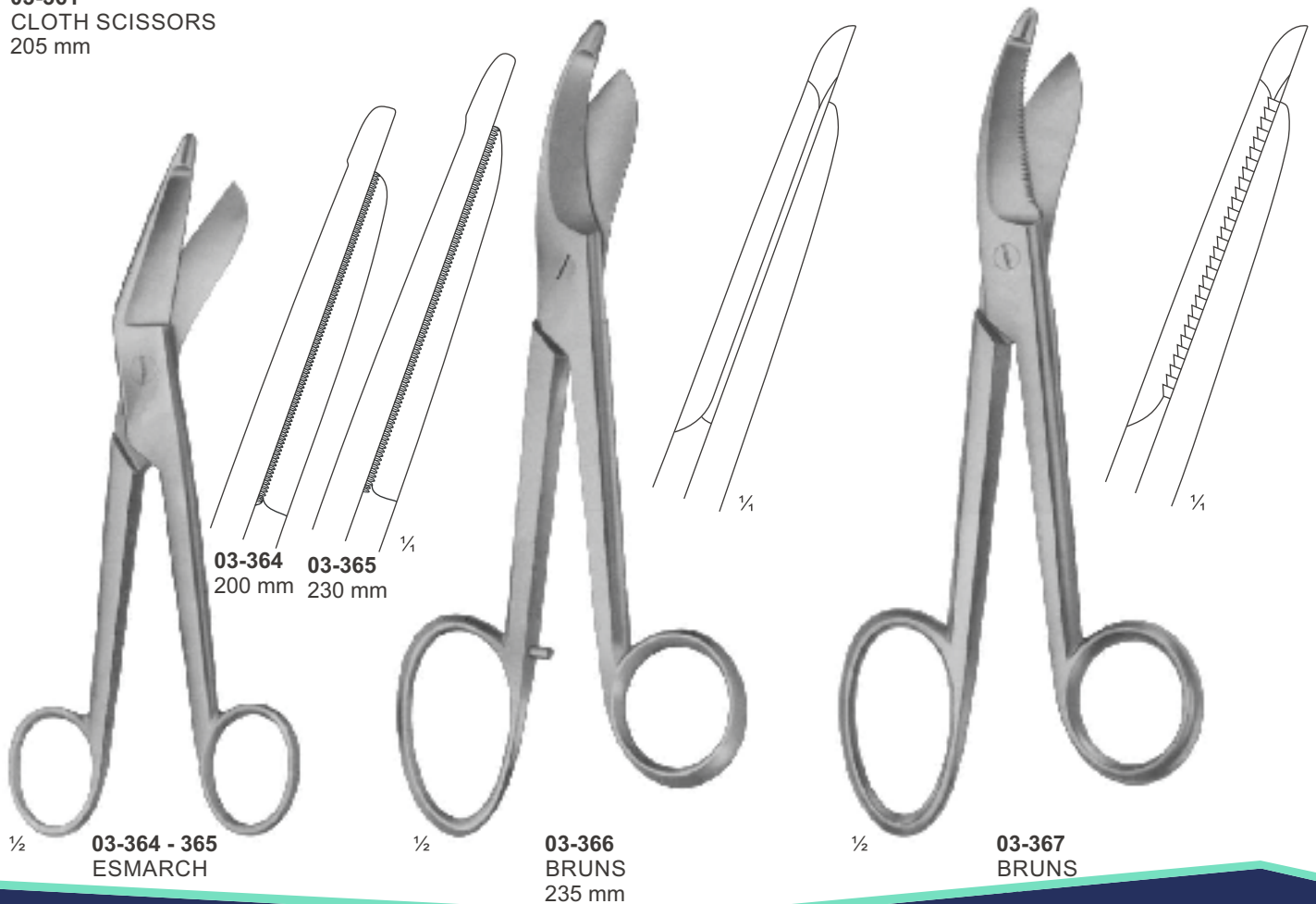

03-364 - 365
ESMARCH

03-366
BRUNS
235 mm

03-367
BRUNS

Micro Forceps, Jeweler Types

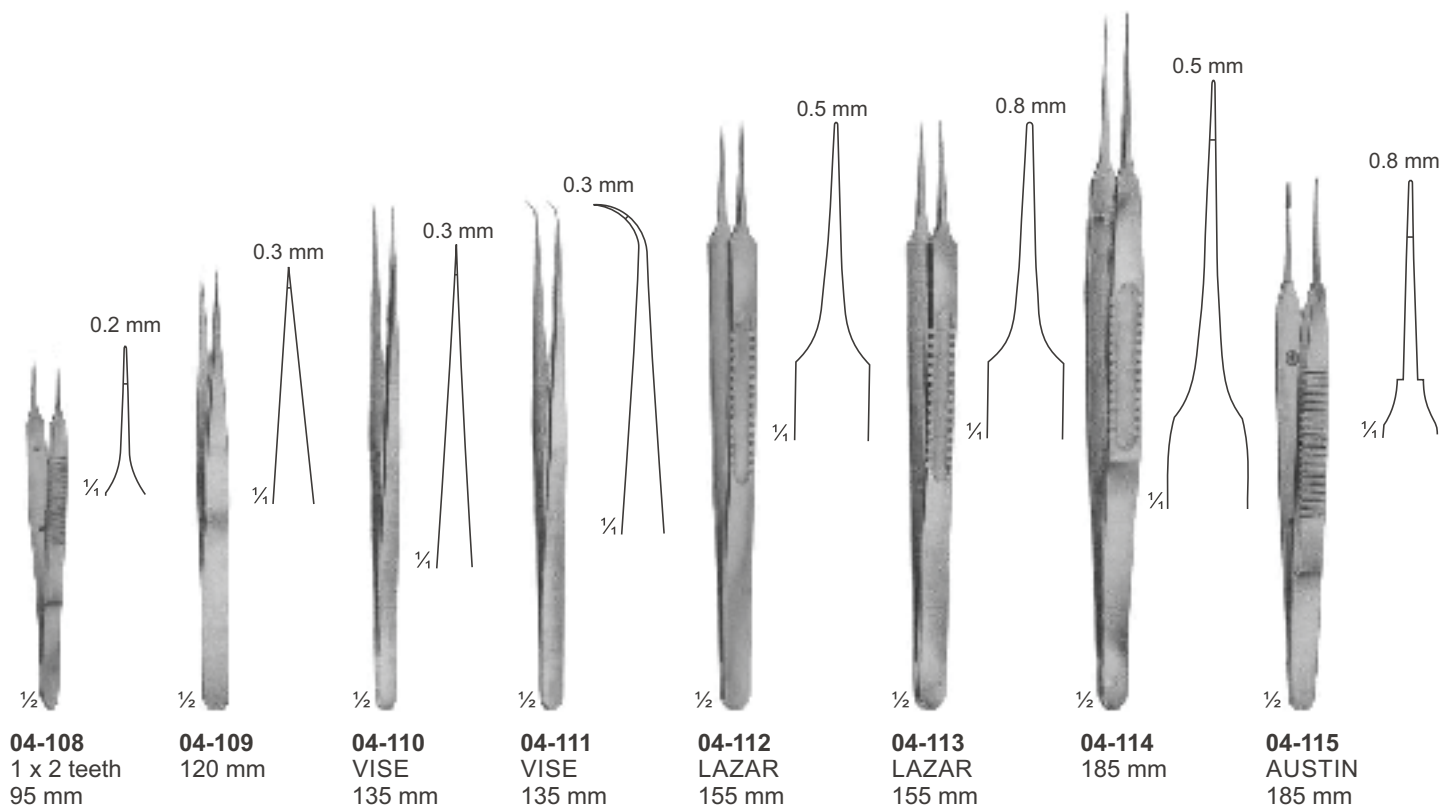
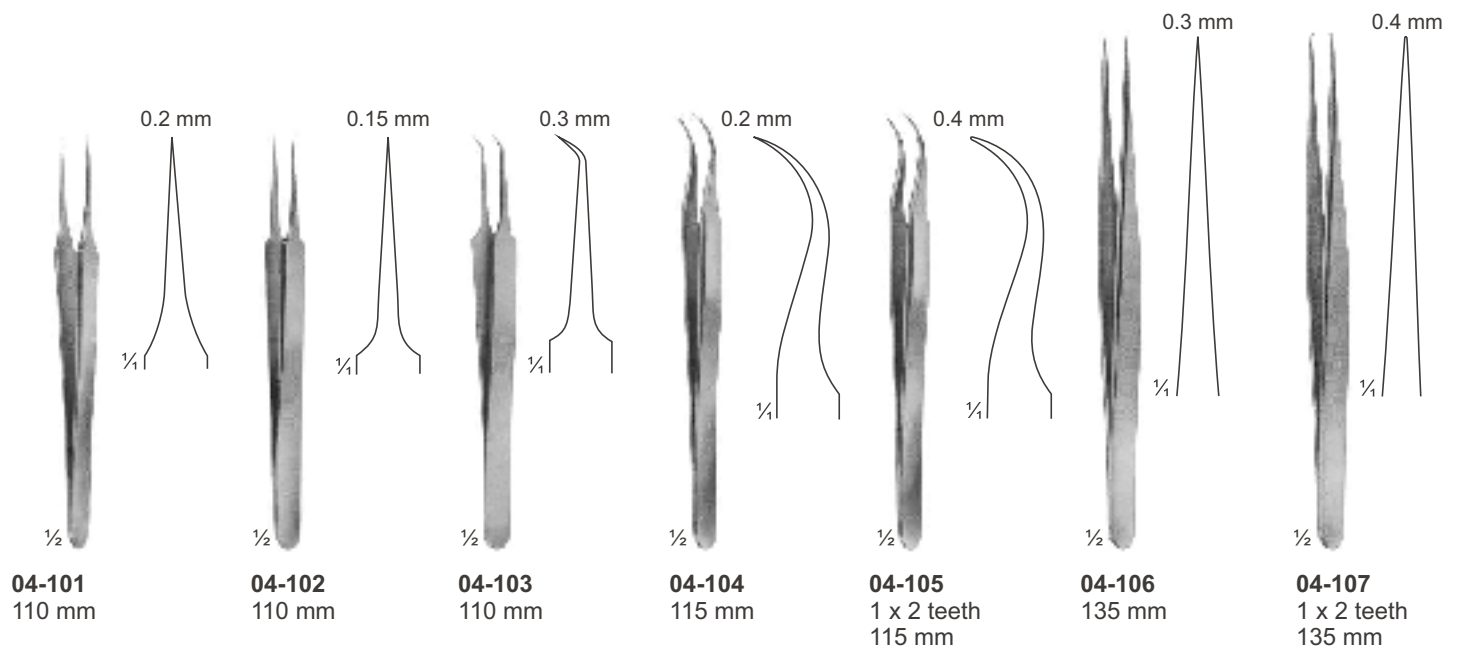

Ligature Forceps, Micro Forceps (Light Patterns)

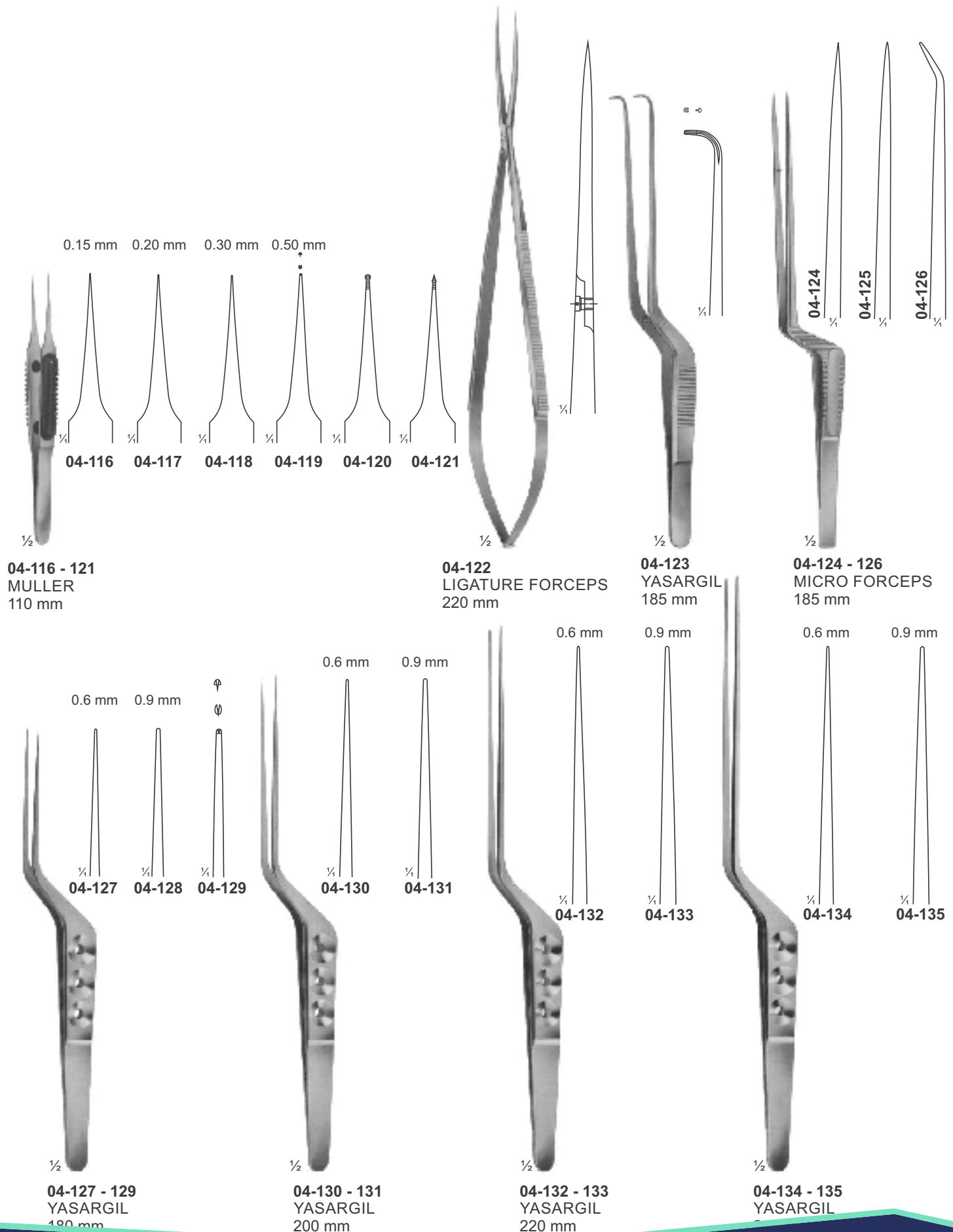

Forceps for Grasping Tissue, Tumors

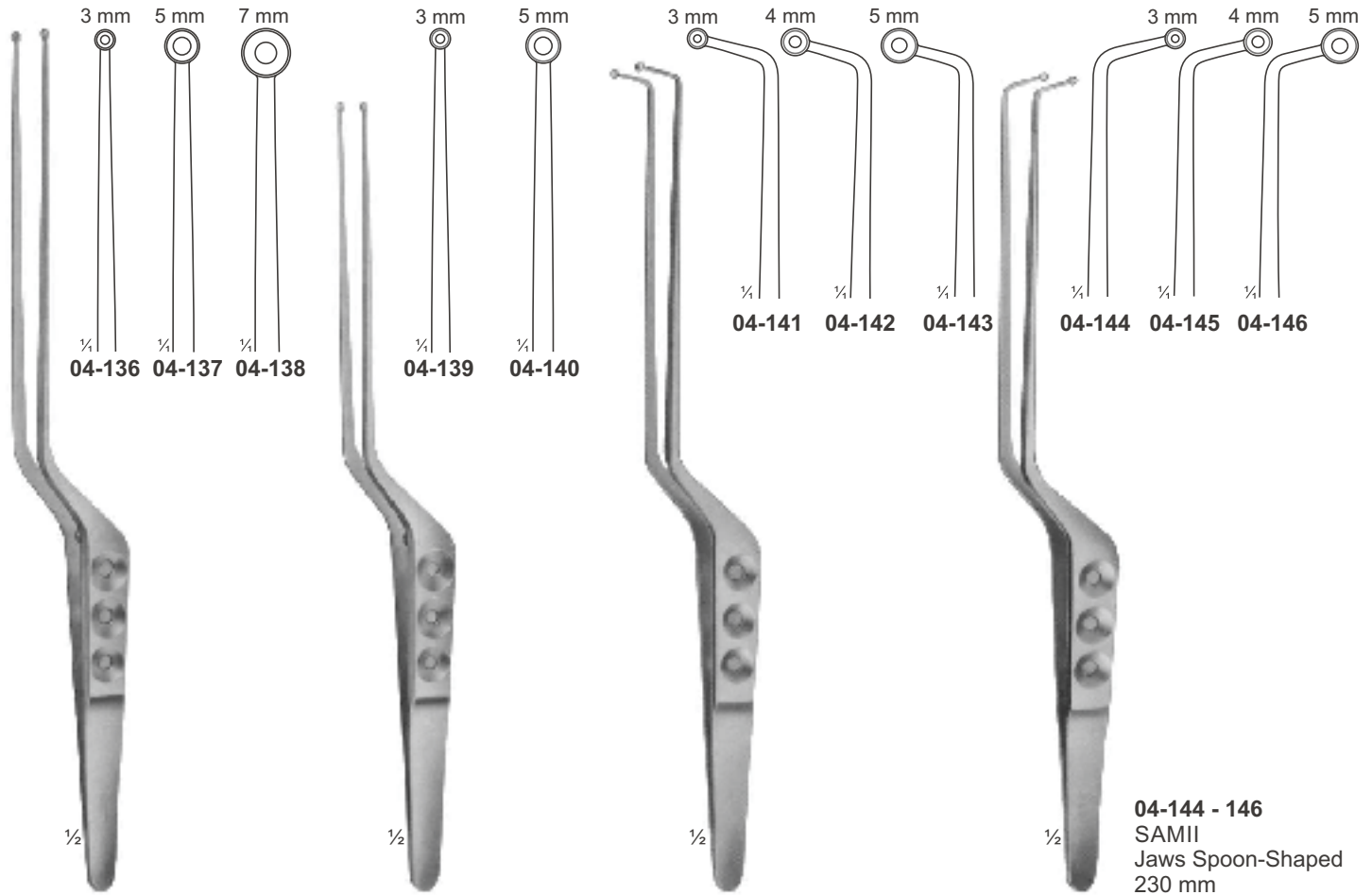

04-136 - 138
YASARGIL-SAMI
Jaws Spoon-Shaped
240 mm

04-139 - 140
YASARGIL
Jaws Spoon-Shaped
220 mm

04-141 - 143
SAMII
Jaws Spoon-Shaped
230 mm

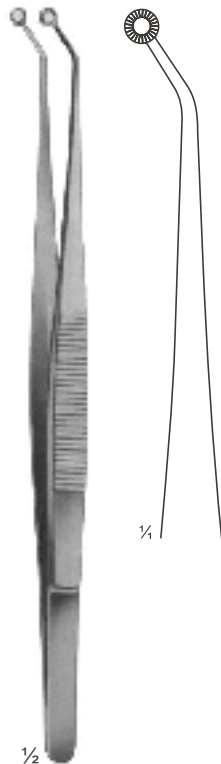

04-147 1/2
HUNT
Tumor-and Vessel Forceps
200 mm

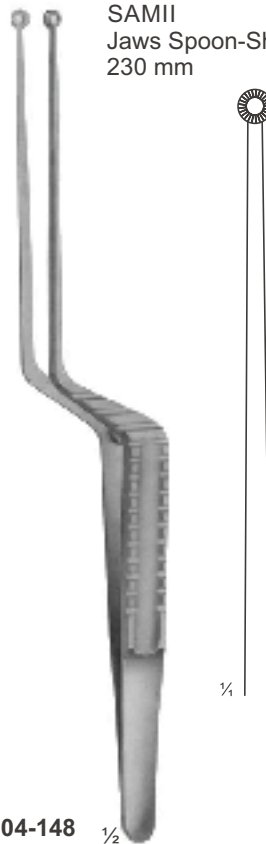

04-148 1/2
HUNT
Tumor-and Vessel Forceps
200 mm

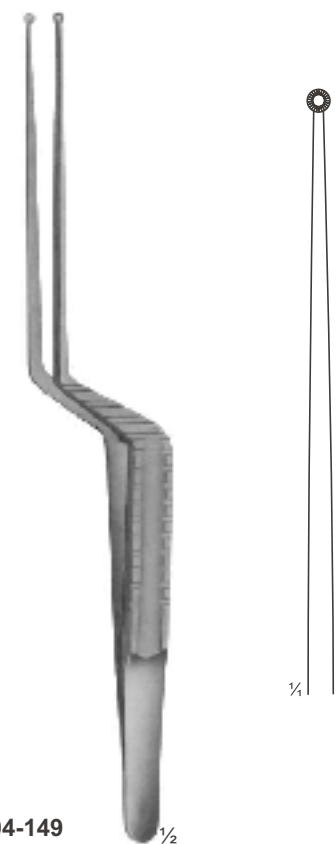

04-149 1/2
YASARGIL
Tumor-and Vessel Forceps
200 mm

Delicate Dissecting, Microscopic, Sterilizing Forceps

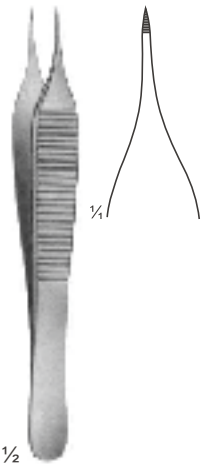

04-150
THORPE
Corneal Forceps
120 mm

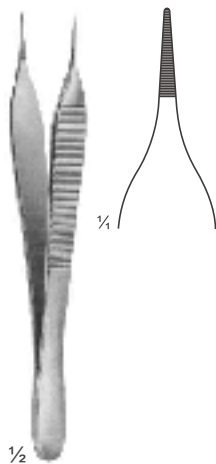

04-151
MICRO-ADSON
120 mm

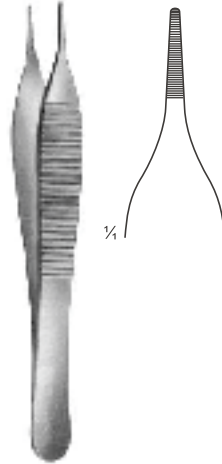

04-152
ADSON
120 mm

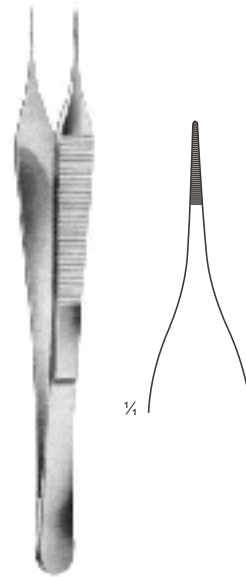

04-153
MICRO-ADSON
150 mm



04-154 - 156
100 mm



04-154



04-155



04-156

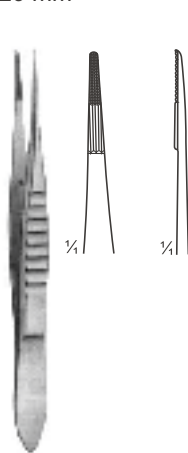

04-157
110 mm

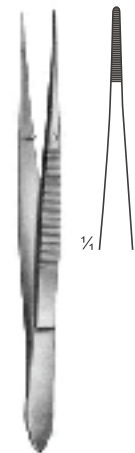

04-158
115 mm



04-159 - 168



04-159
90 mm



04-160
105 mm



04-161
115 mm



04-162
130 mm



04-163
145 mm



04-164
90 mm



04-165
105 mm



04-166
115 mm



04-167
130 mm



04-168
145 mm

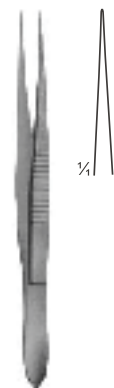

04-169
100 mm

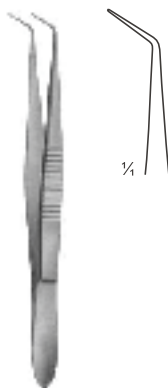

04-170
100 mm

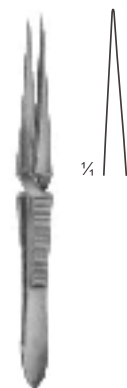

04-171
100 mm

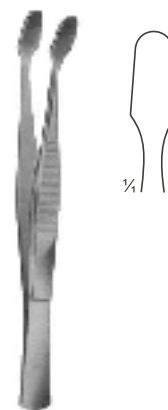

04-172
COVER GLASS FORCEPS
105 mm



04-173
160 mm

Delicate Dissecting Forceps

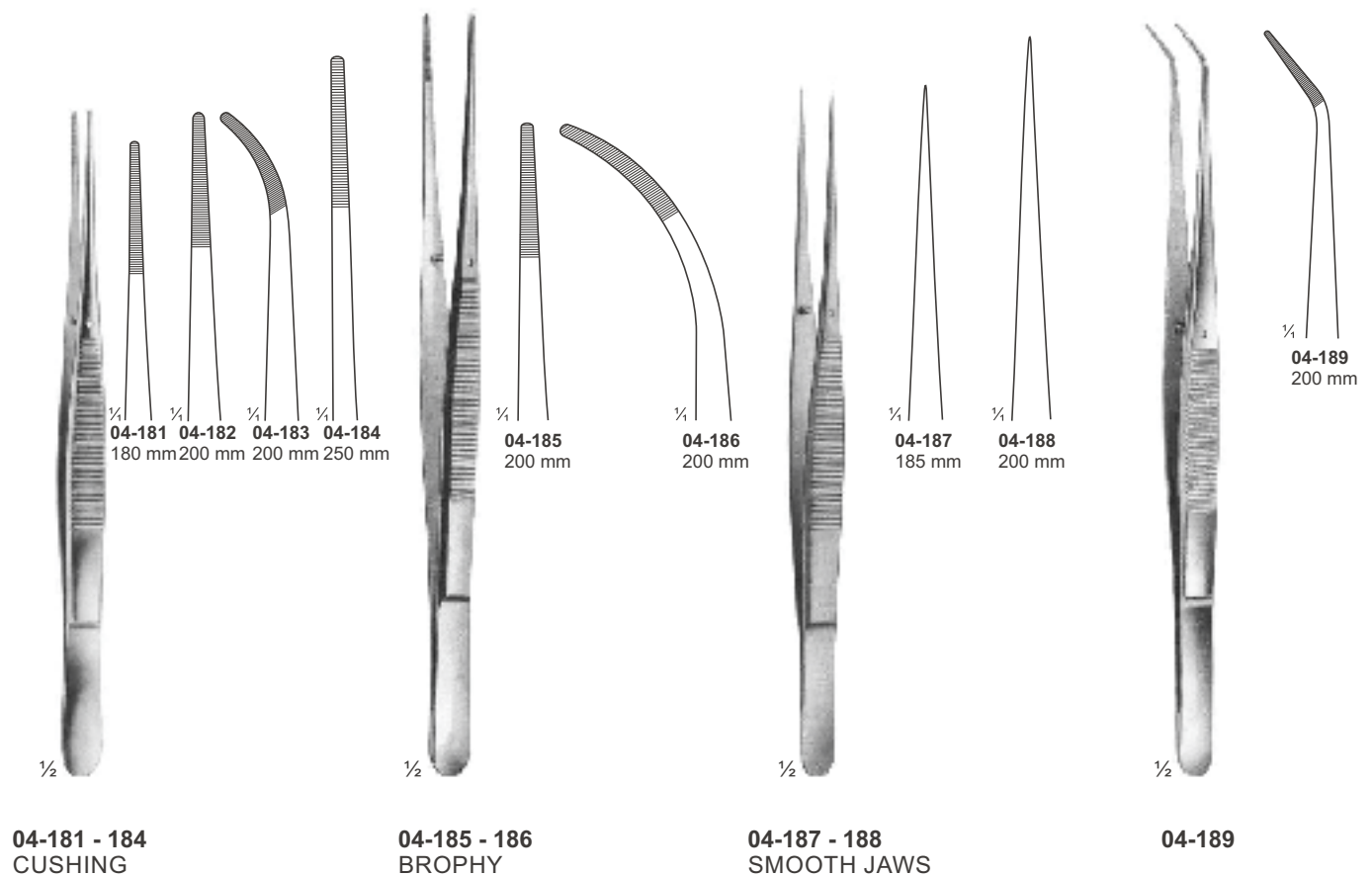
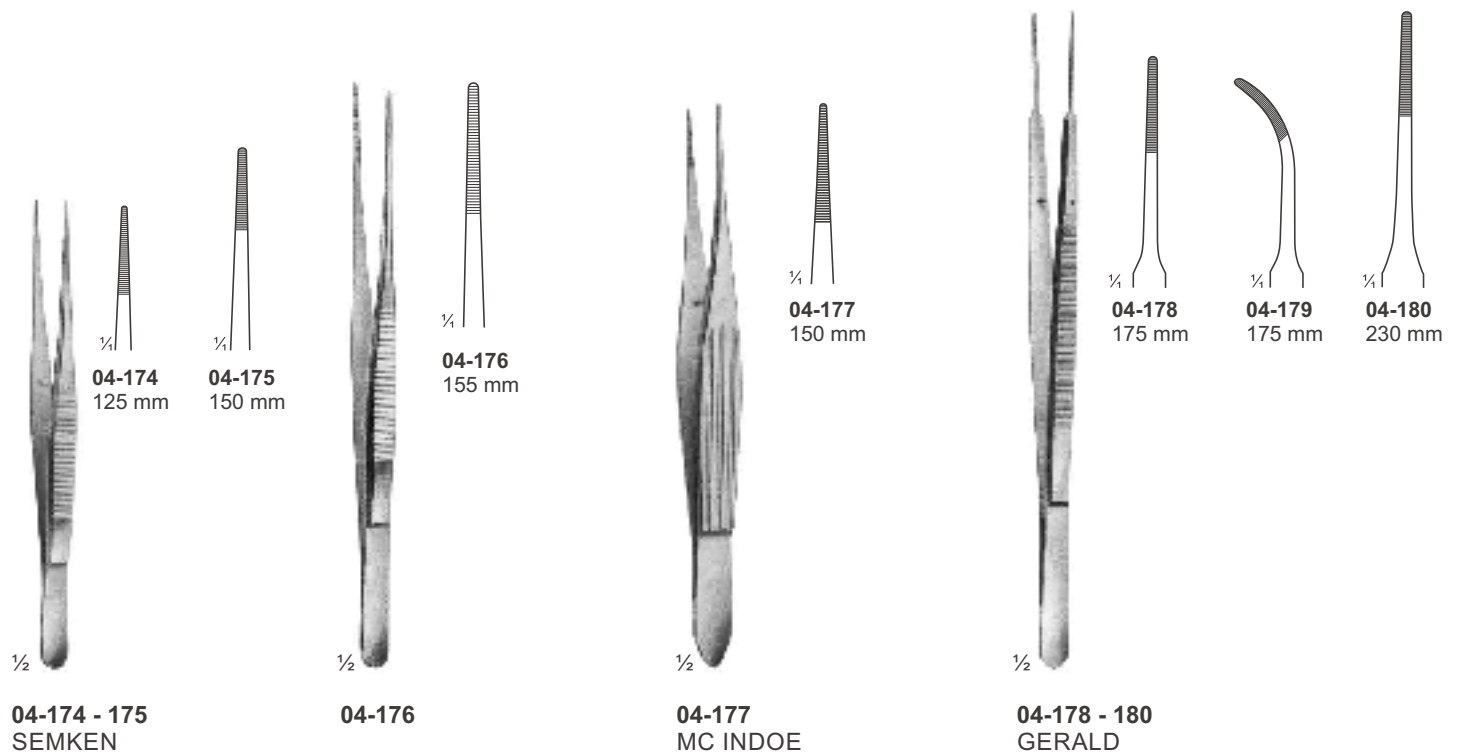

Dissecting Forceps



1/2

04-190 - 197
STANDARD

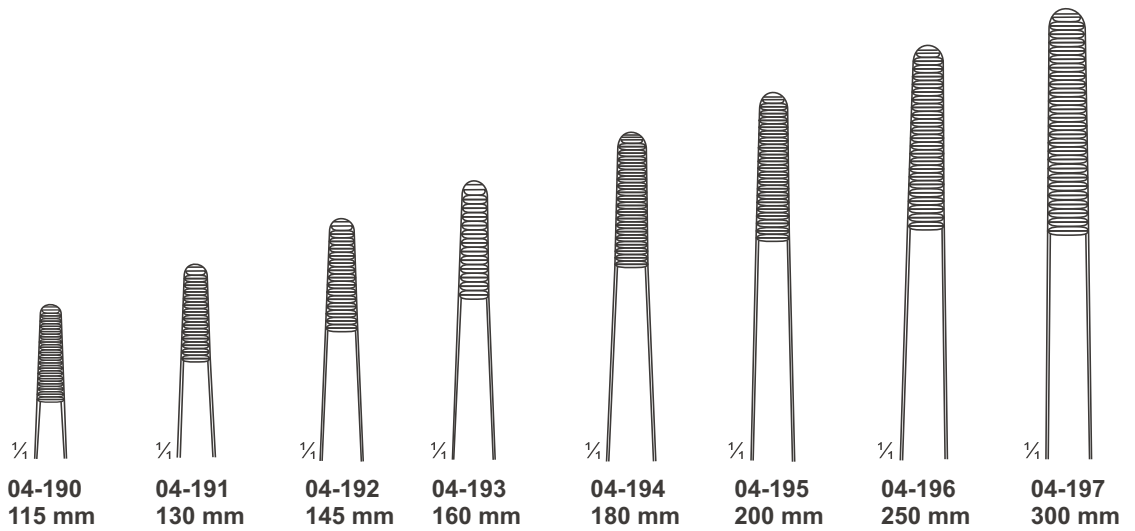

1/2

04-198 - 202
MEDIUM

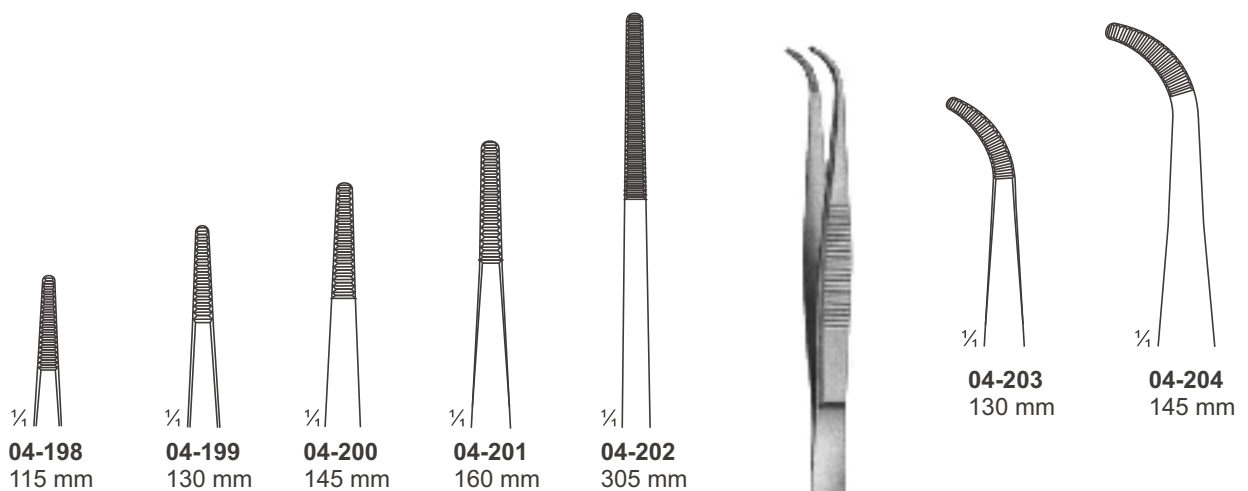

1/2

04-203 - 204
MEDIUM

Dissecting Forceps

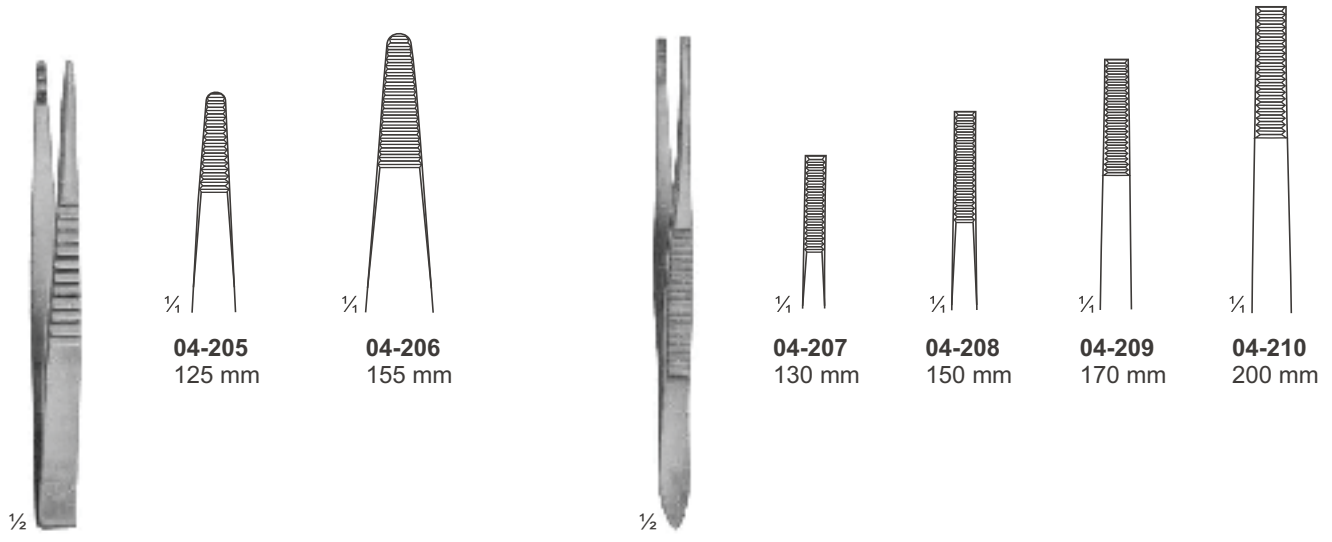

04-205
125 mm

04-206
155 mm

04-207
130 mm

04-208
150 mm

04-209
170 mm

04-210
200 mm

04-205 - 206

04-207 - 210



04-211
OCHSNER

04-212
FRICKE

04-213
BONNEY

Ultra-Light Forceps

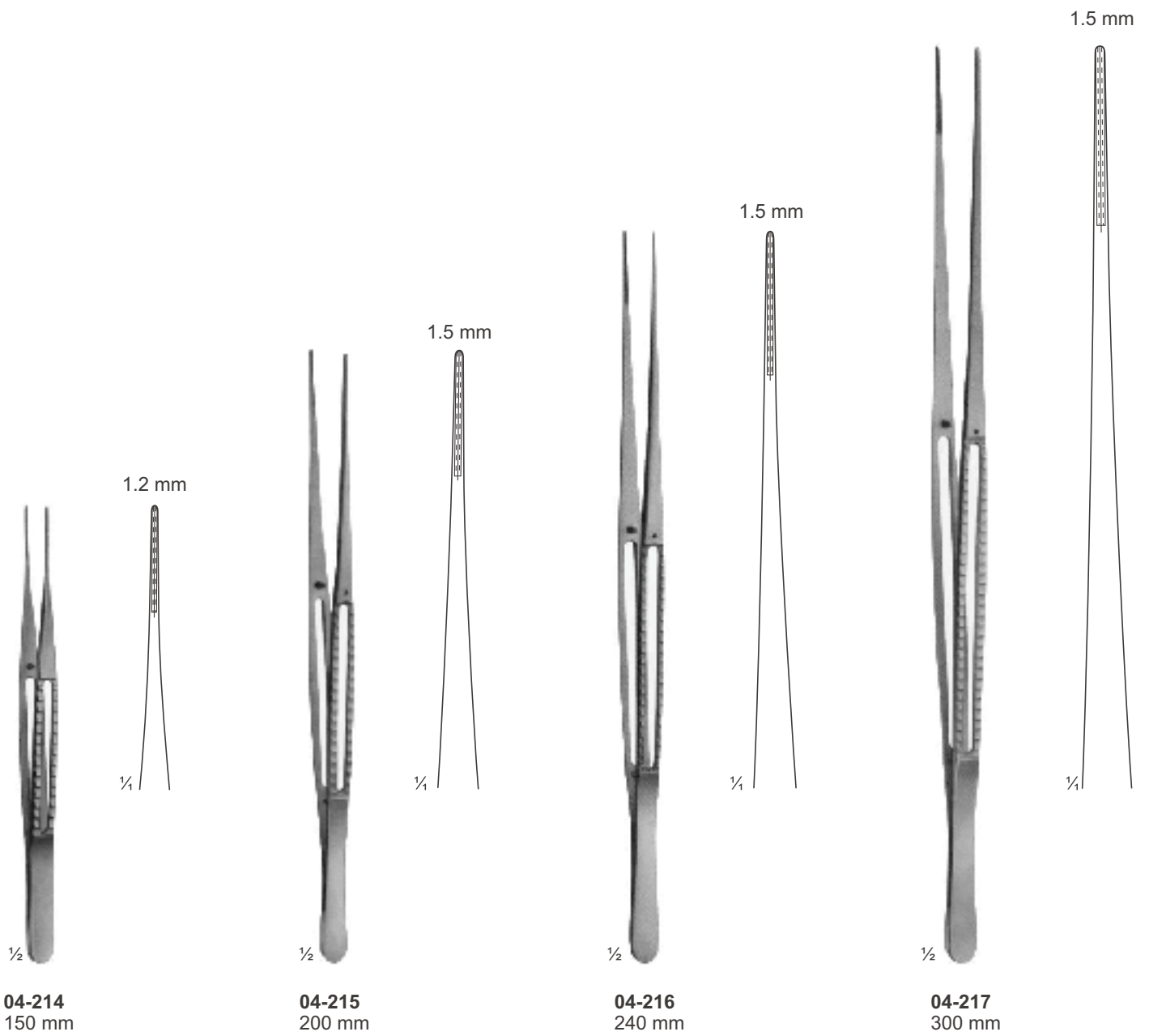

Forceps

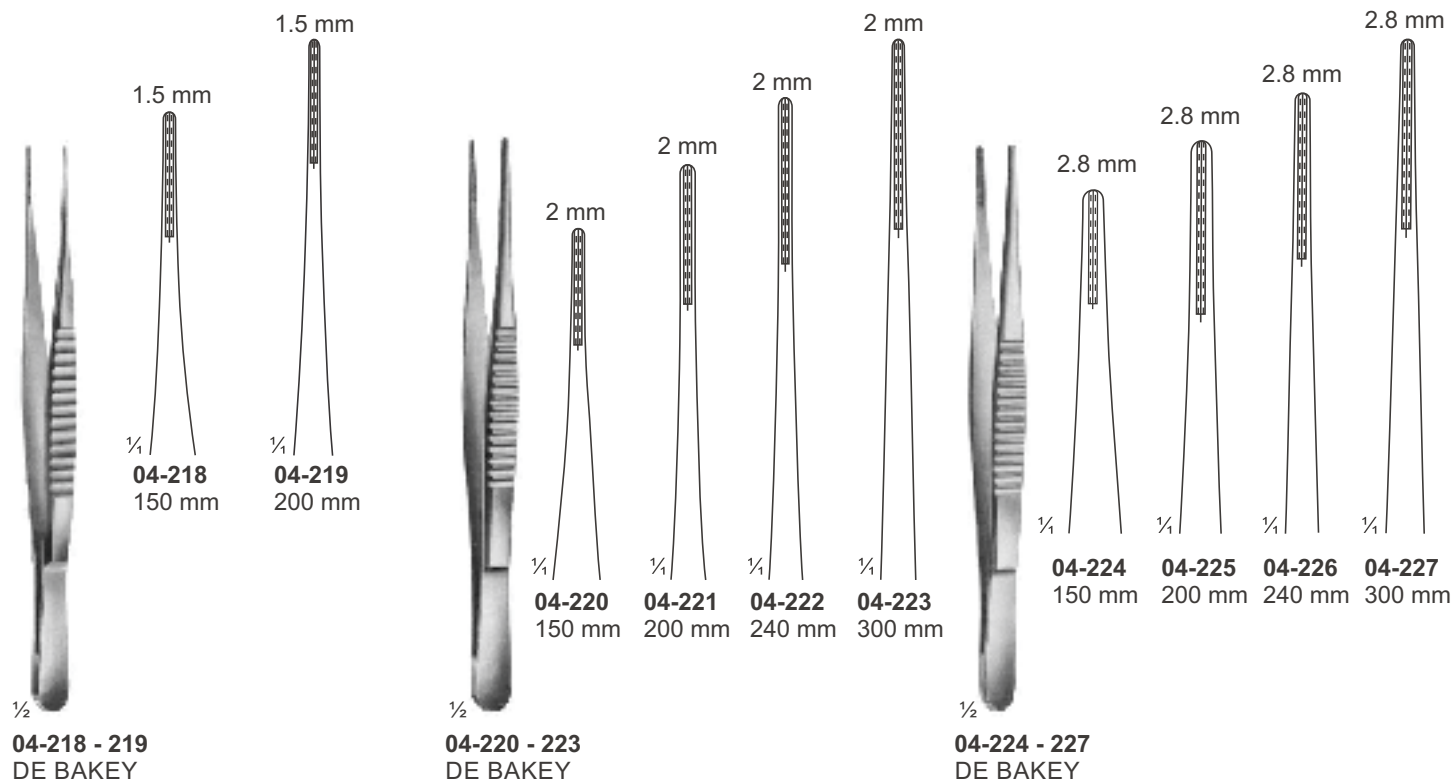

04-218 - 219
DE BAKAY
1.5 mm
150 mm

04-219
200 mm

04-220 - 223
DE BAKAY
2 mm
150 mm
200 mm
240 mm
300 mm

04-224 - 227
DE BAKAY
2.8 mm
150 mm
200 mm
240 mm
300 mm

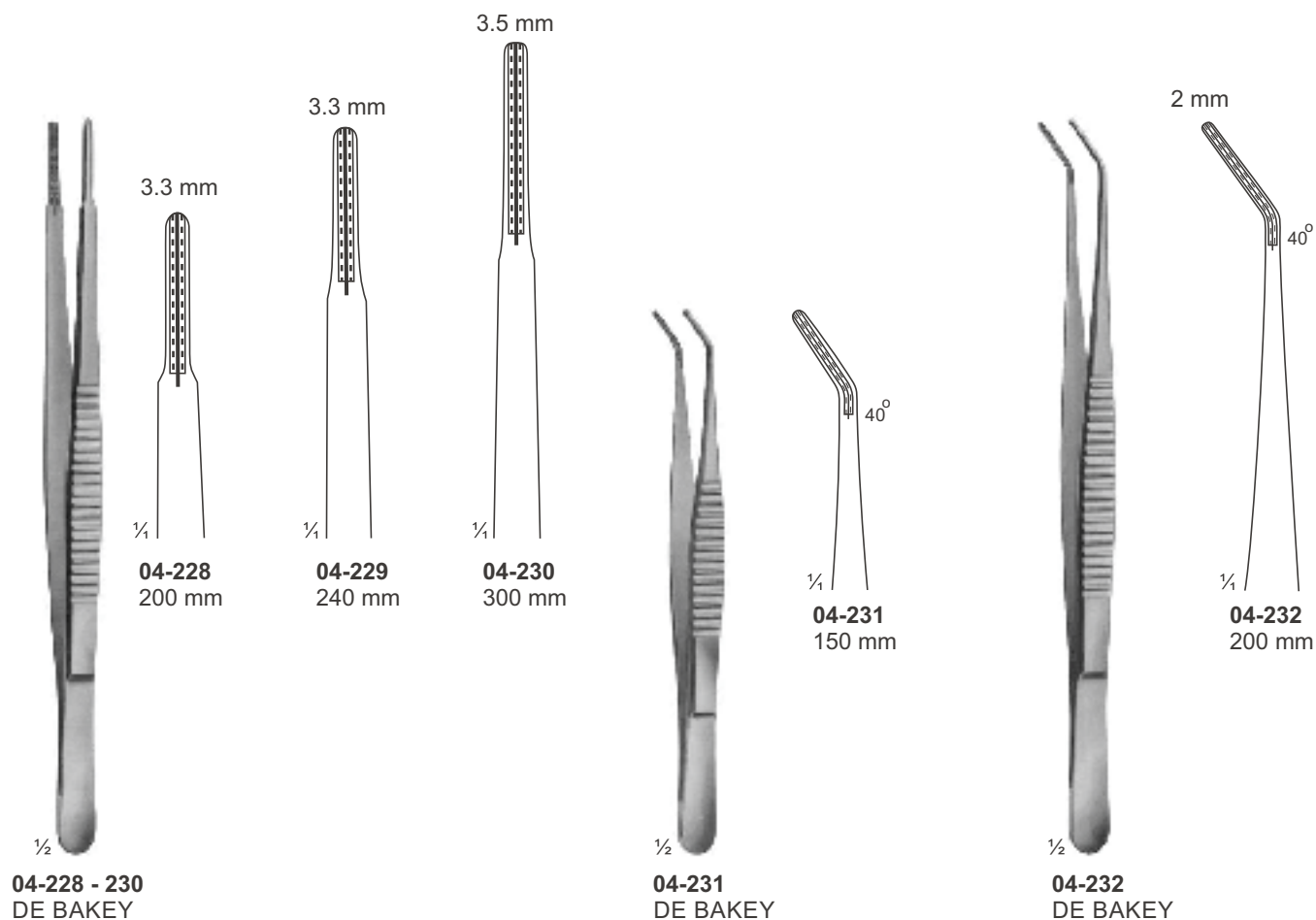

04-228 - 230
DE BAKAY
3.3 mm
200 mm

04-229
240 mm

04-230
300 mm

04-231
DE BAKAY
40°
150 mm

04-232
DE BAKAY
2 mm
40°
200 mm

Forceps, Bayonet - Shaped

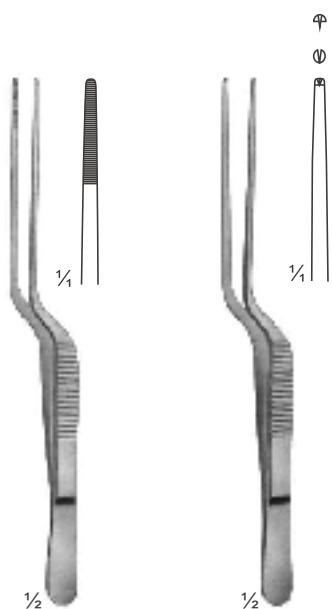

04-233
LUCAE
140 mm

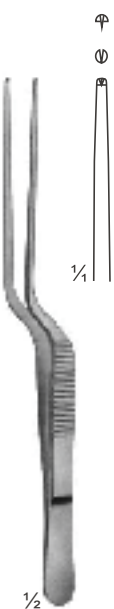

04-234
LUCAE
1x2 teeth
140 mm



04-235
COTTLE
Forceps with
jaws toothed
and serrated
140 mm

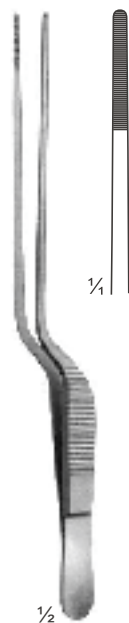

04-236
JANSEN
160 mm

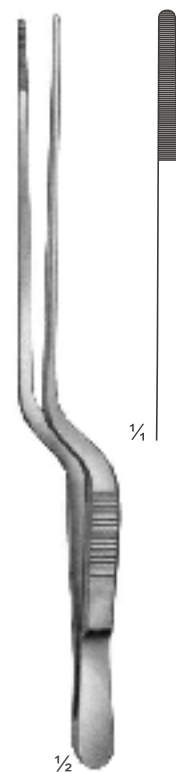

04-237
GRUENWALD
200 mm

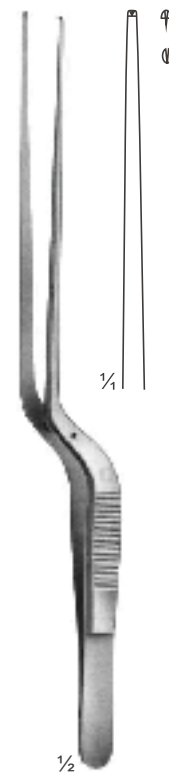

04-238
1x2 teeth
200 mm

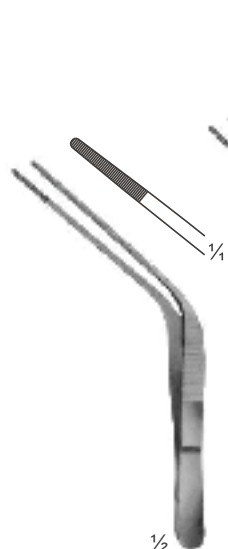

04-239
TROELTSCH
100 mm

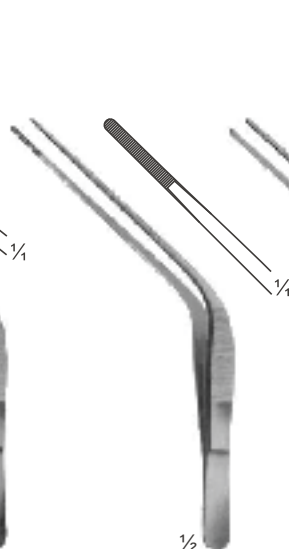

04-240
TROELTSCH
115 mm

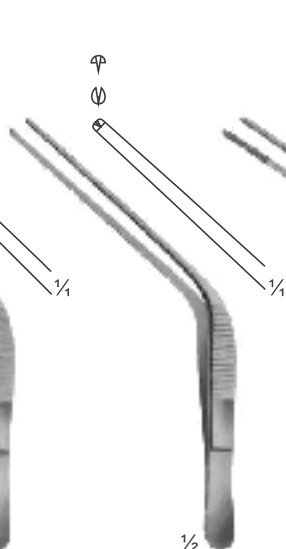

04-241
TROELTSCH
1X2 teeth
115 mm

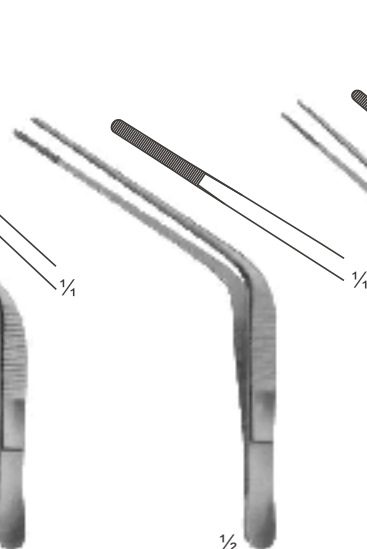

04-242
WILDE
115 mm

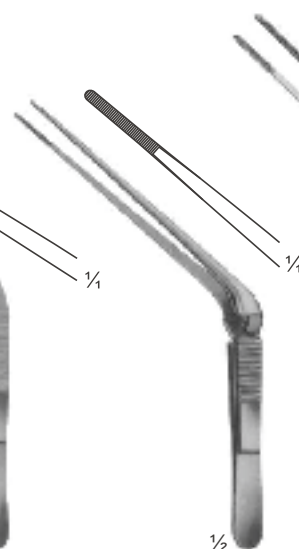

04-243
TROELTSCH
Cross action
120 mm

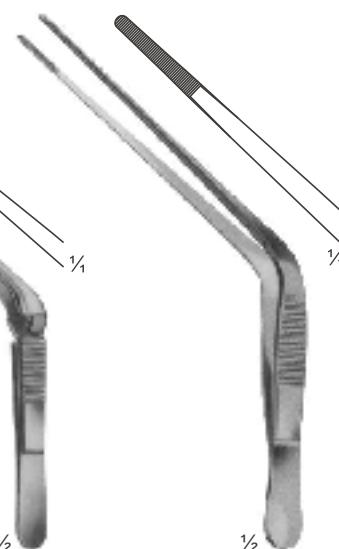

04-244
TROELTSCH
140 mm

Delicate Tissue Forceps

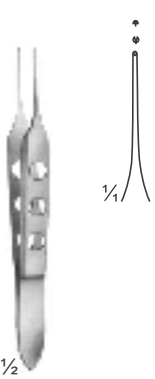

04-245
BISHOP-HARMON
85 mm

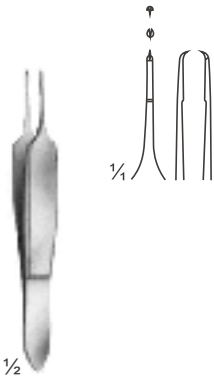

04-246
ST.MARTIN
80 mm

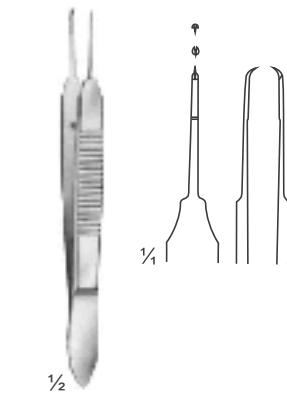

04-247
CASTROVIEJO
teeth 0.9 mm
100 mm

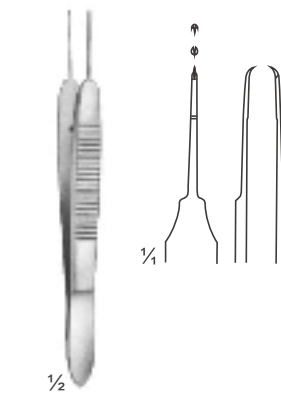

04-248
CASTROVIEJO
teeth 0.5 mm
100 mm

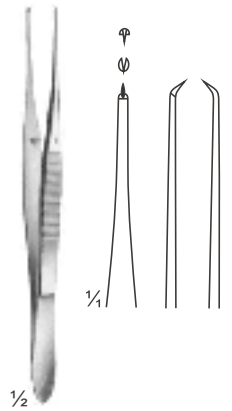

04-249
ELSCHING
110 mm

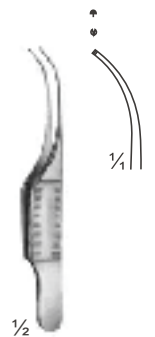

04-250
GILL
75 mm

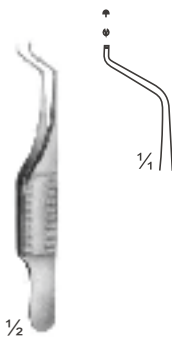

04-251
GILL - HESS
75 mm

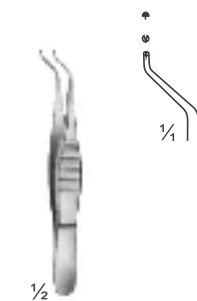

04-252
HESS
70 mm

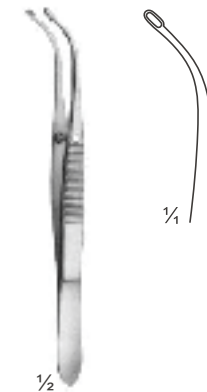

04-253
ARRUGA
100 mm

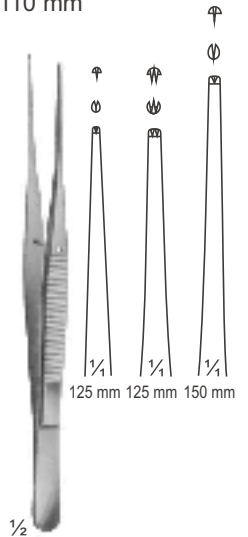

04-254
SEMKEN
125 mm 125 mm 150 mm

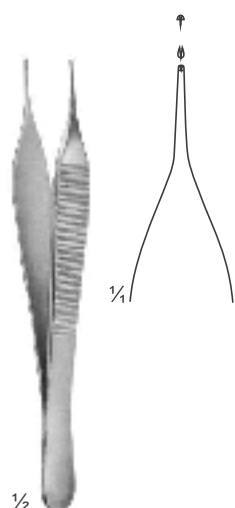

04-255
MICRO-ADSON
120 mm

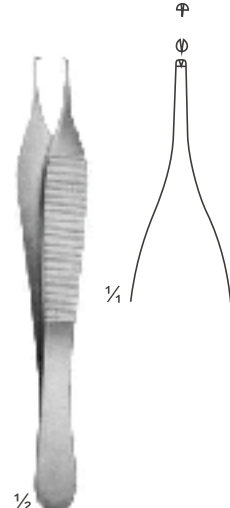

04-256
ADSON
120 mm

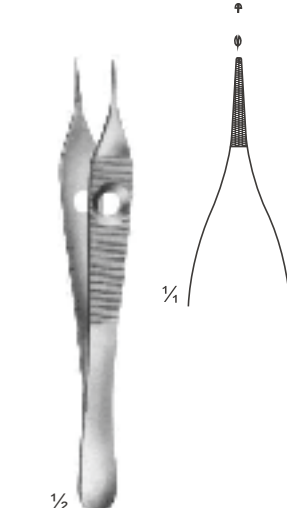

04-257
ADSON
120 mm



04-258
ADSON
120 mm

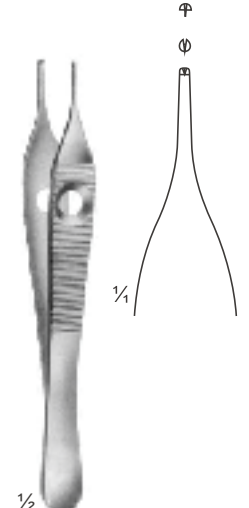

04-259
ADSON
150 mm

Tissue Forceps

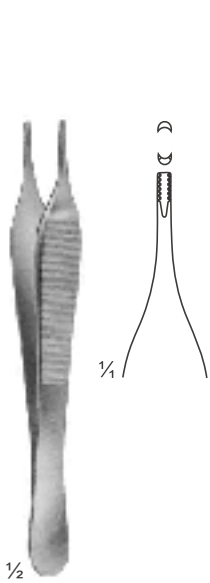

04-260
ADSON - BROWN
Non-traumatic
120 mm

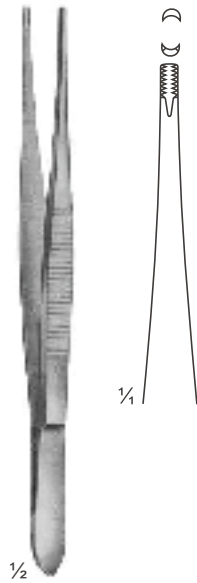

04-261
BROWN
120 mm

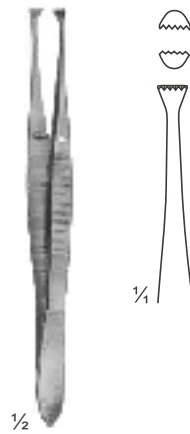

04-262
GRAEFE
110 mm

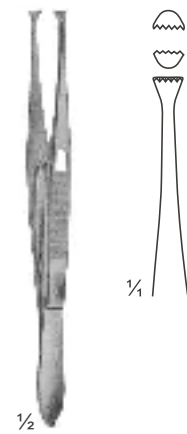

04-263
GRAEFE
With Catch
110 mm

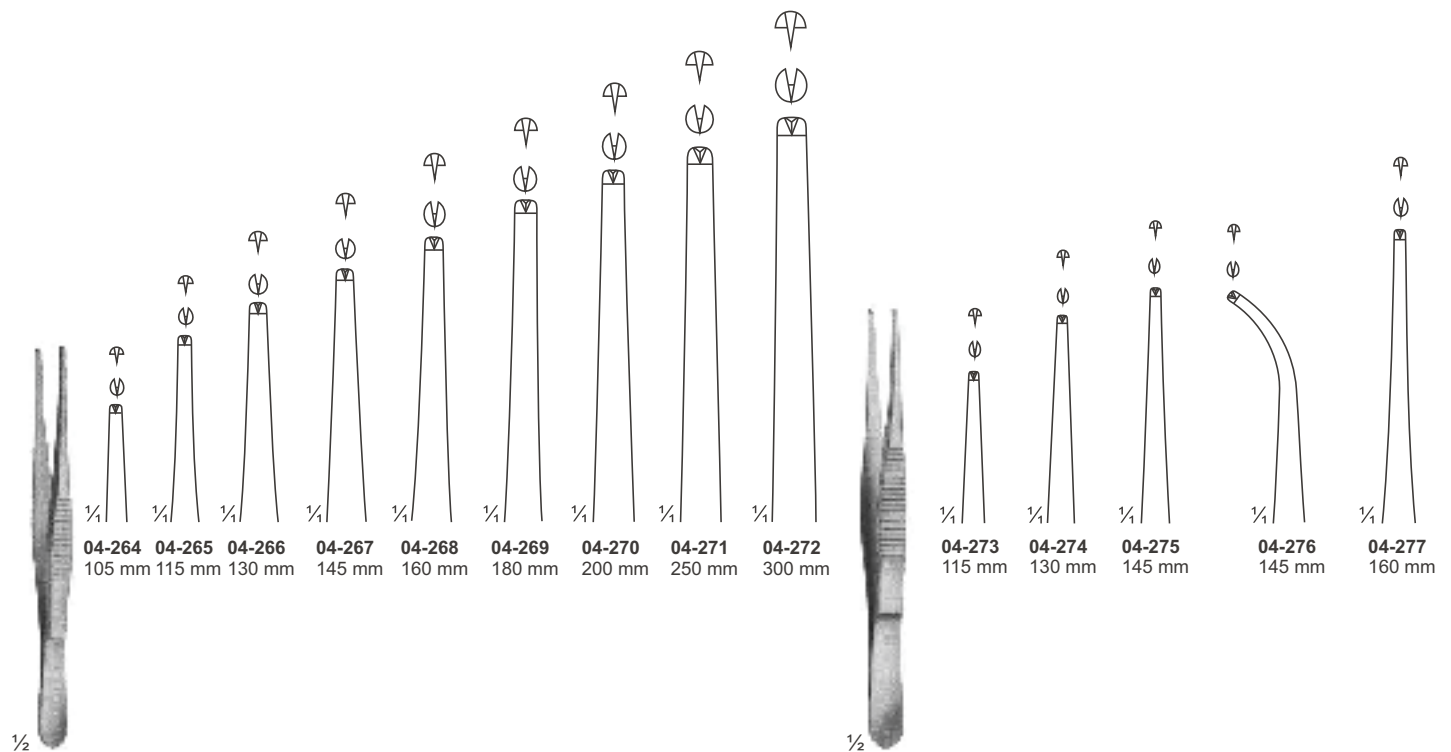

04-264 - 272
STANDARD

04-273 - 277
GRAEFE
110 mm

Tissue Forceps

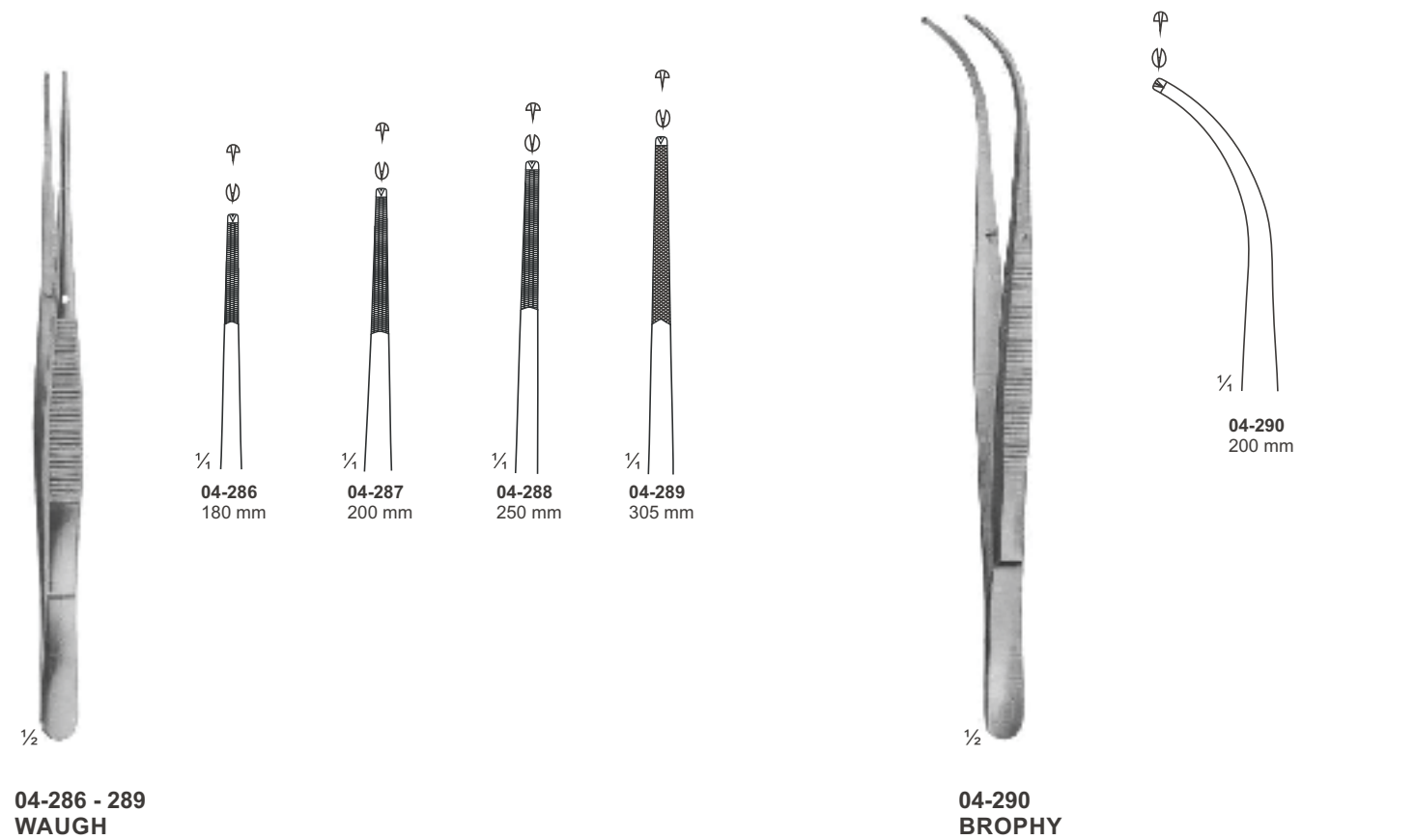
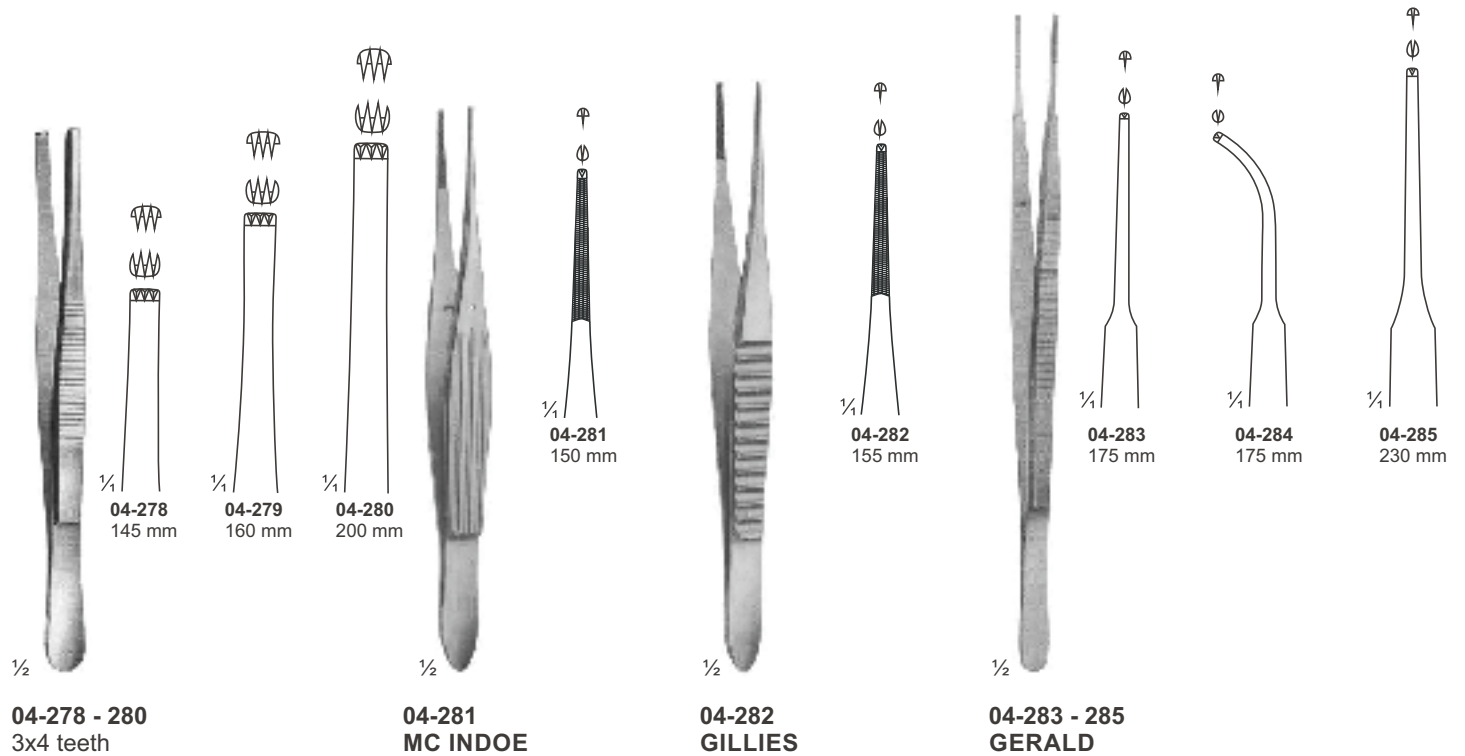

Tissue Forceps, Lung Dissecting Forceps

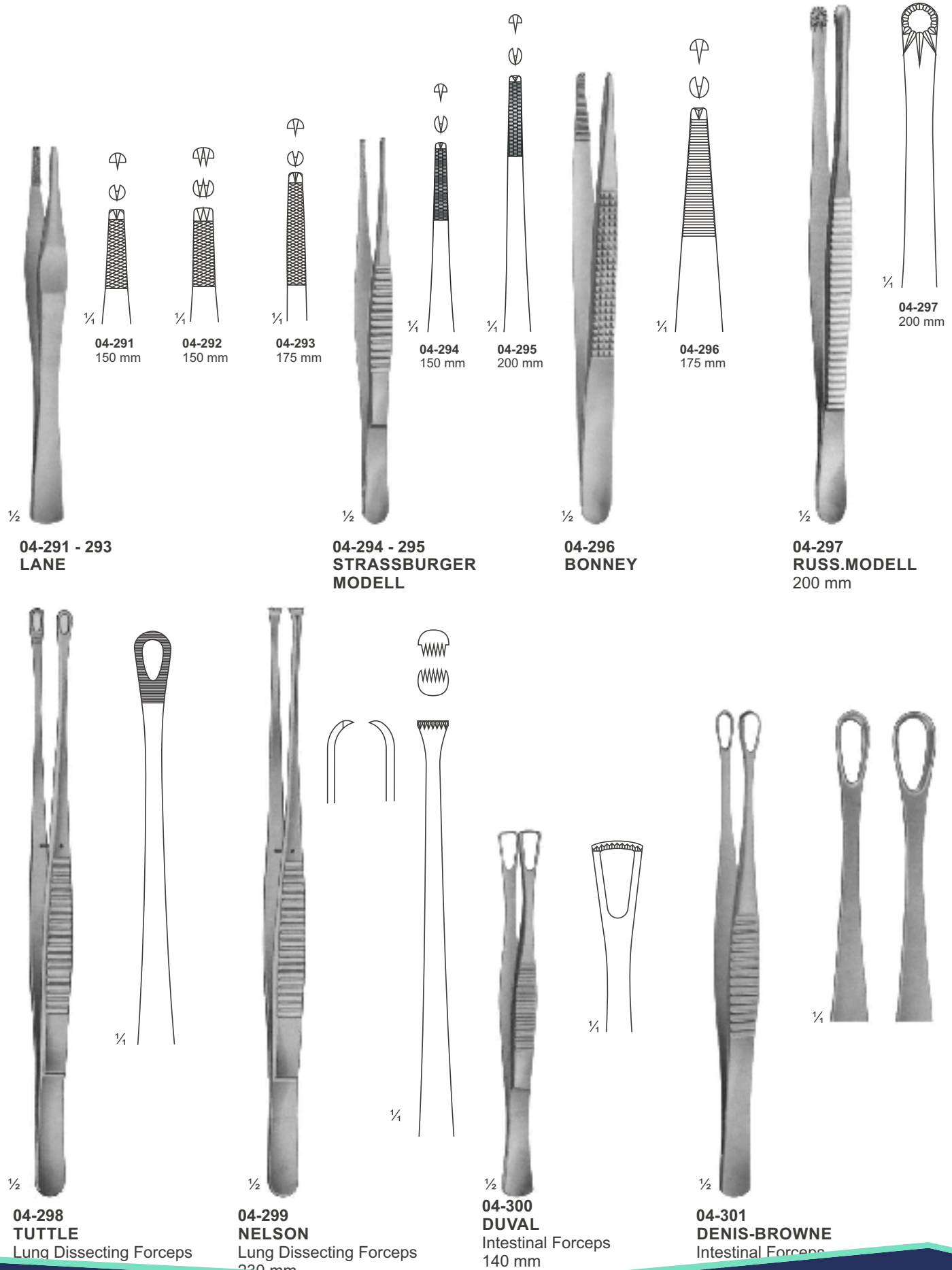

Splinter and Cilia Forceps

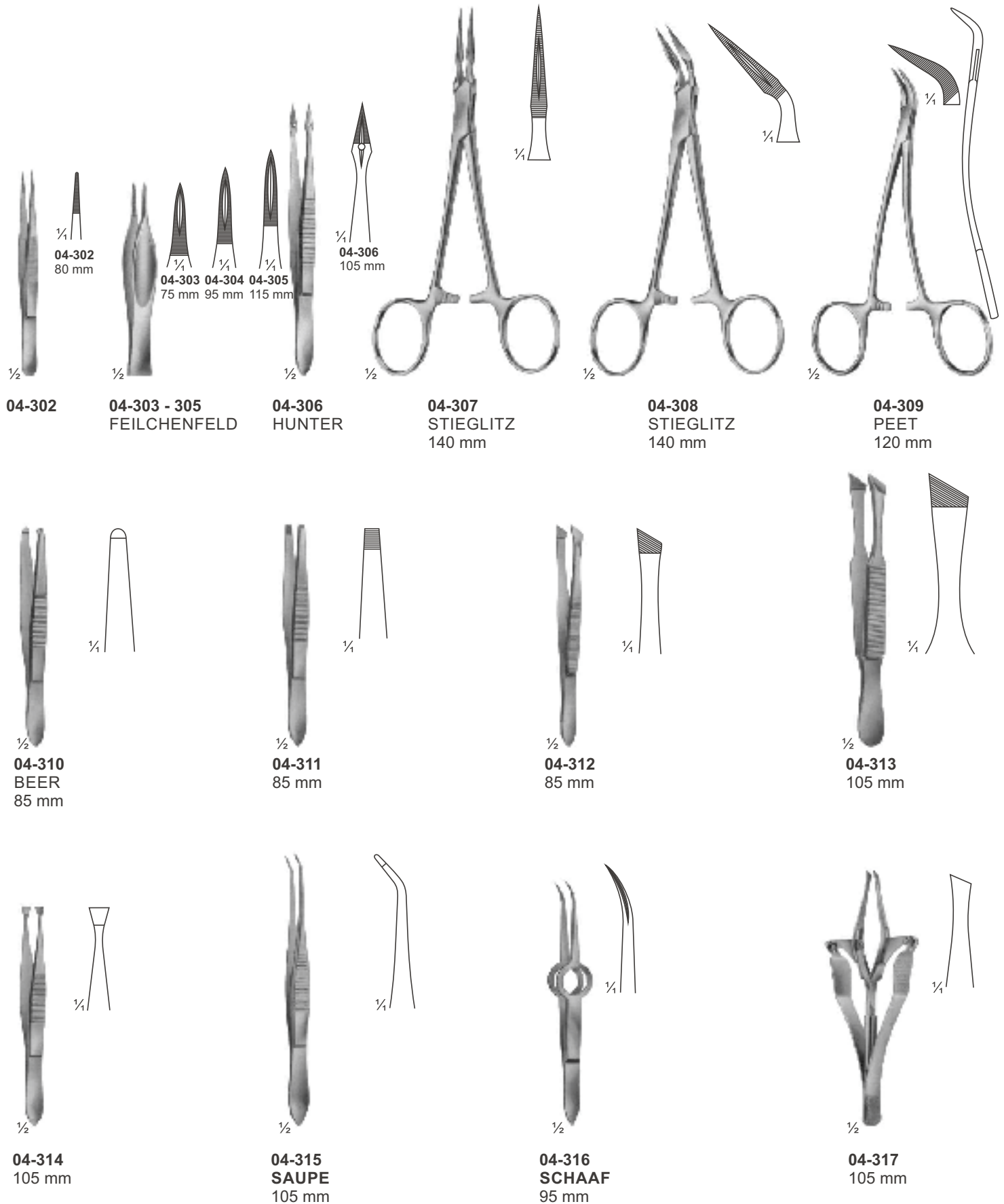

Sponge and Dressing Forceps

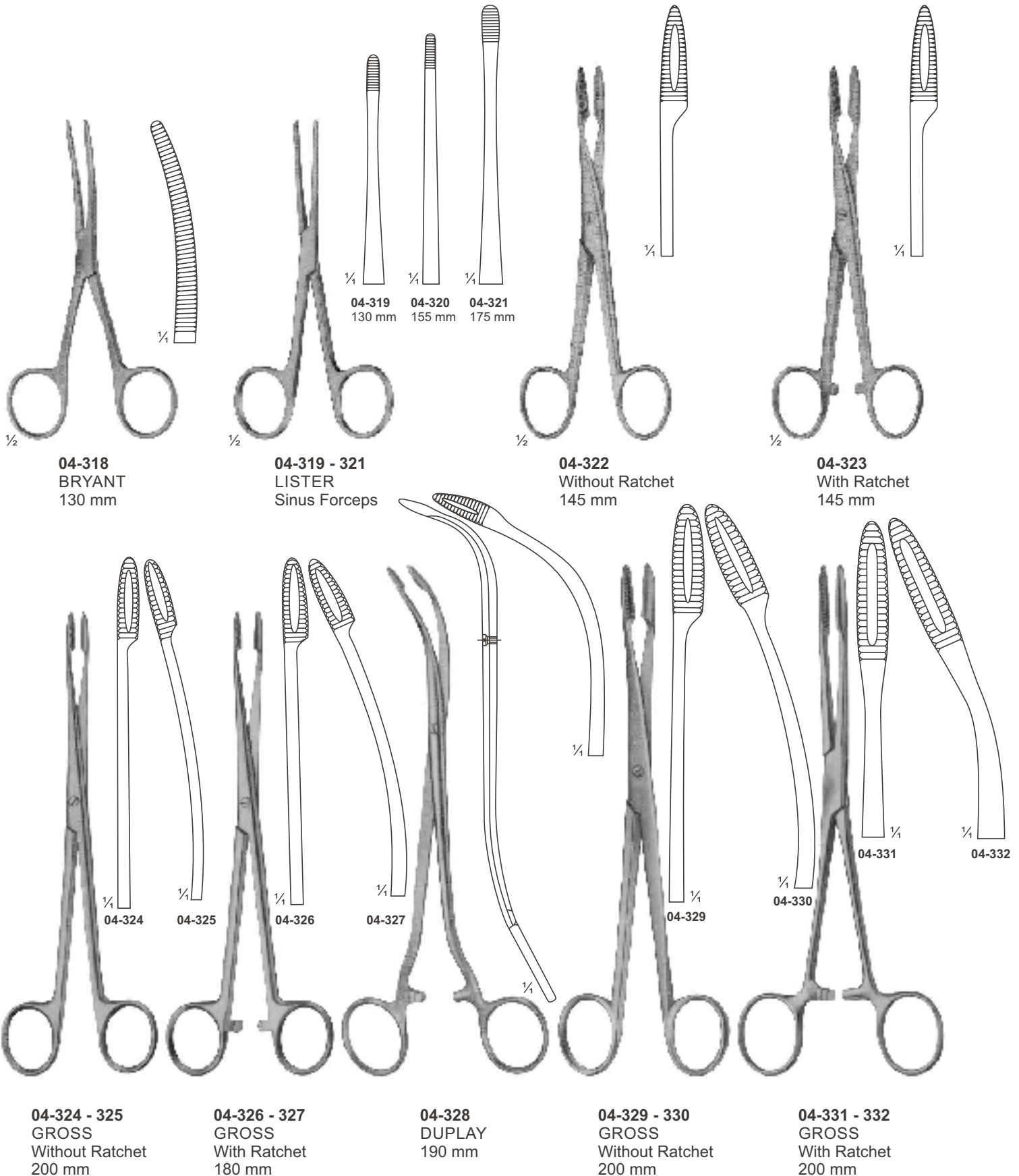

Sponge and Dressing Forceps



04-333 - 334
AESCULAP
220 mm

04-335 - 336
MAIER
Without Ratchet
265 mm

04-337 - 338
MAIER
With Ratchet
265 mm

Sponge and Dressing Forceps

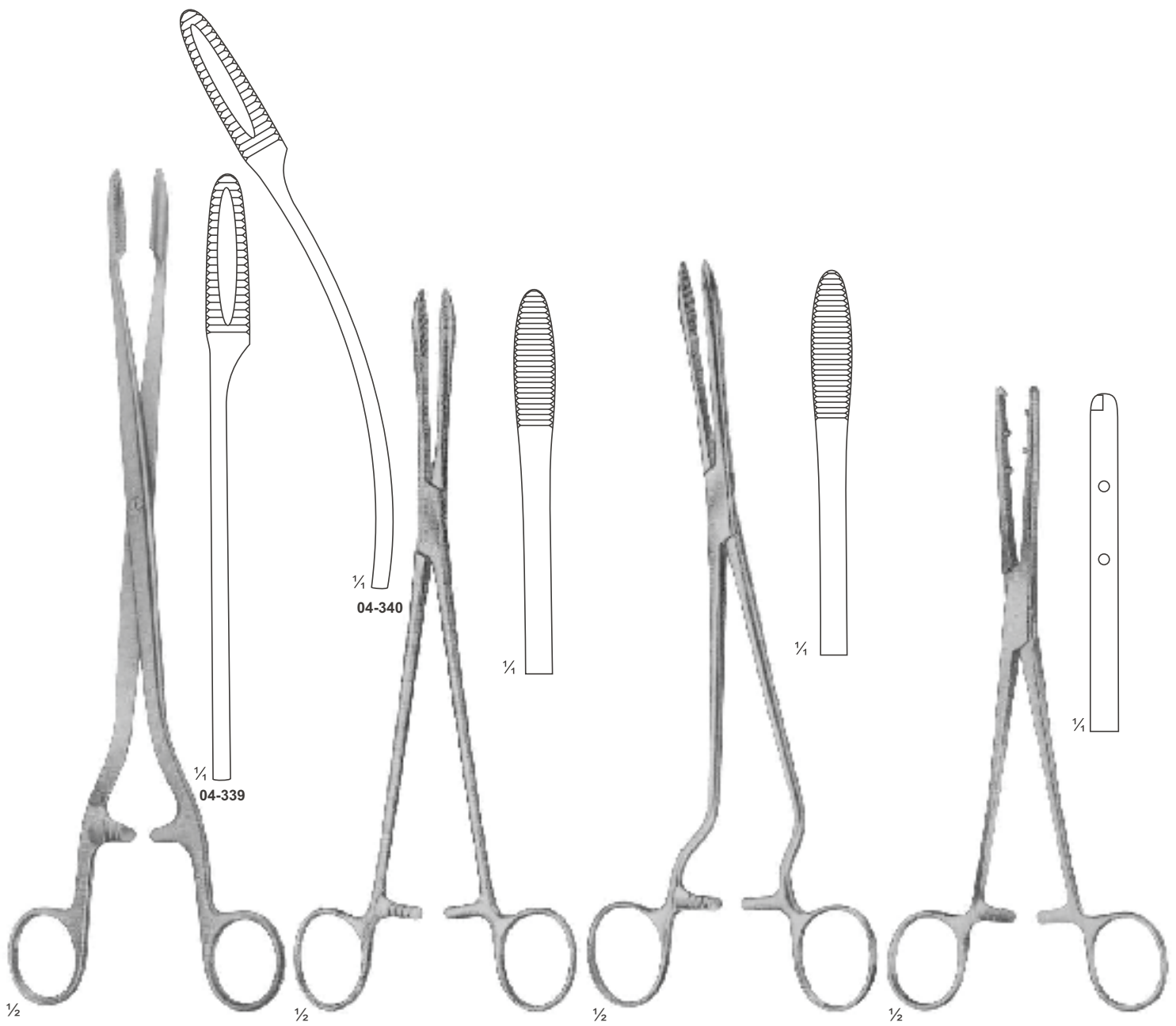

04-339 - 340
SIMS-MAIER
280 mm

04-341
COLLIN
240 mm

04-342
CHERON
Handles Laterally Angled
240 mm

04-343
EMMET
210 mm

Dressing, Sponge holding, Organ and Tissue Grasping Forceps

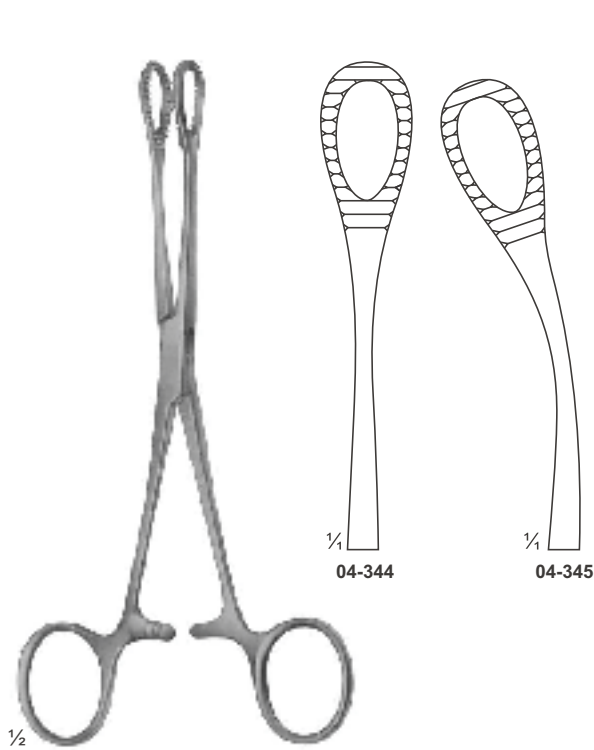

04-344

04-345

1/2

04-344 - 345
FOERSTER-BALLENGER
180 mm

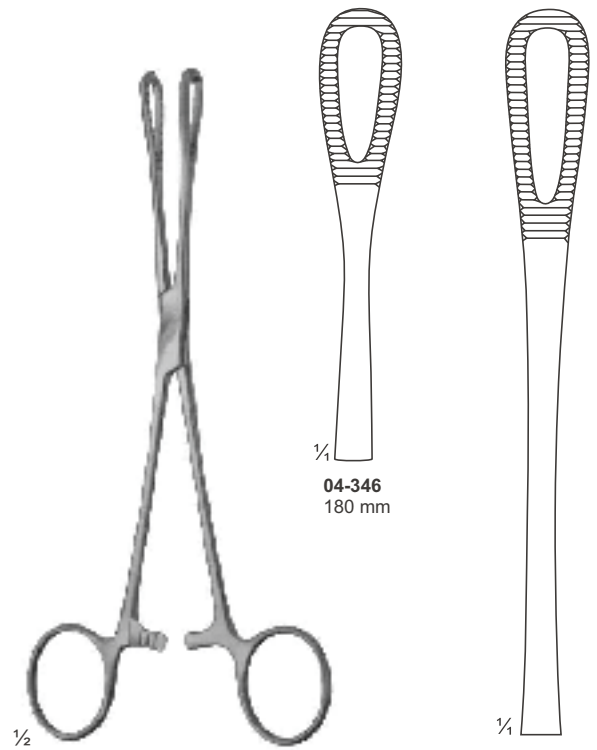

1/4

04-346
180 mm

1/4

04-347
250 mm

1/2

04-346 - 347
RAMPLEY

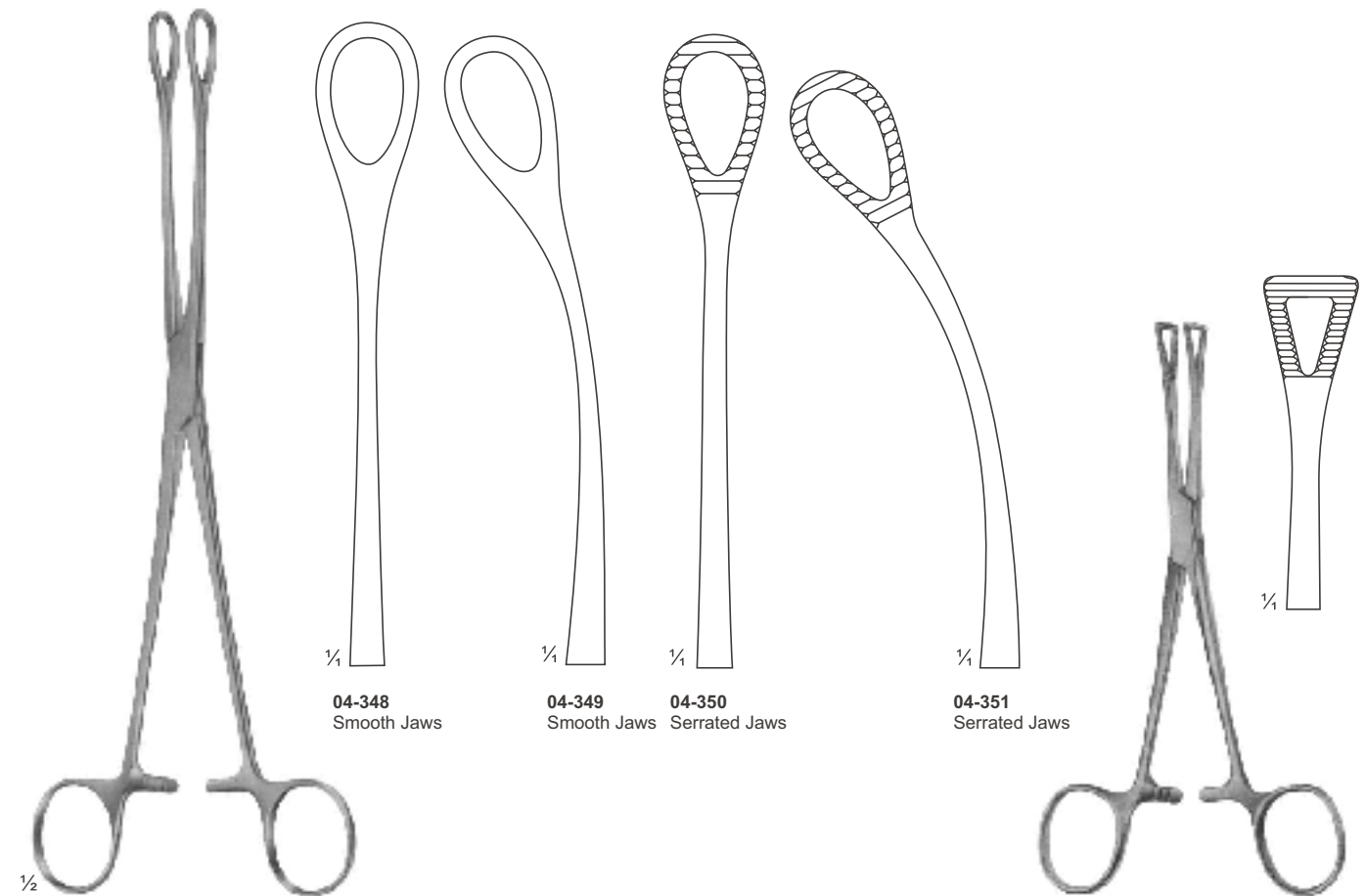

04-348

Smooth Jaws

04-349

Smooth Jaws

04-350

Serrated Jaws

04-351

Serrated Jaws

1/4

1/2

04-348 - 351
FOERSTER-BALLENGER
240 mm

04-352
PENNINGTON
155 mm

Dressing, Sponge holding, Organ and Tissue Grasping Forceps

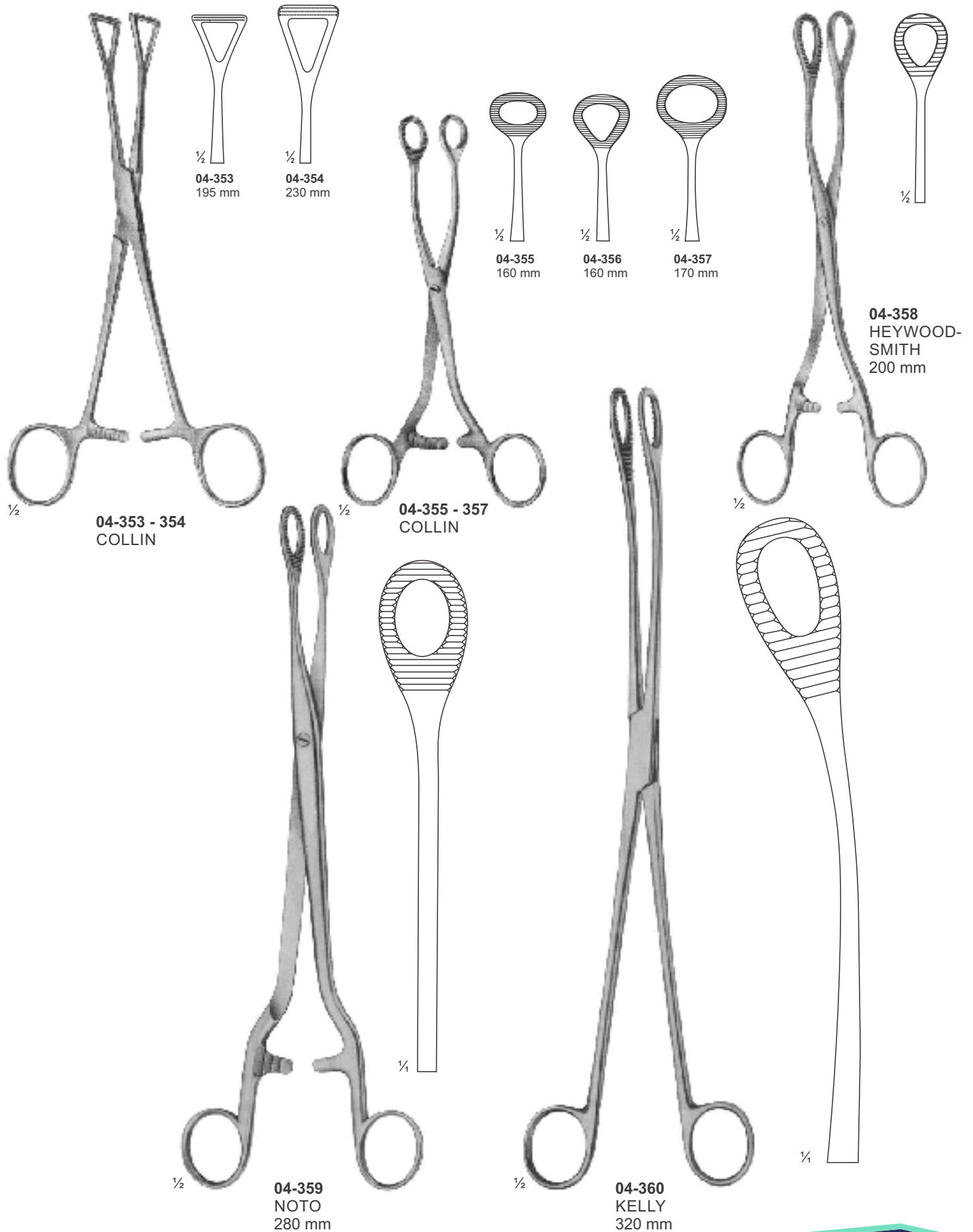

Tendon Seizing Forceps

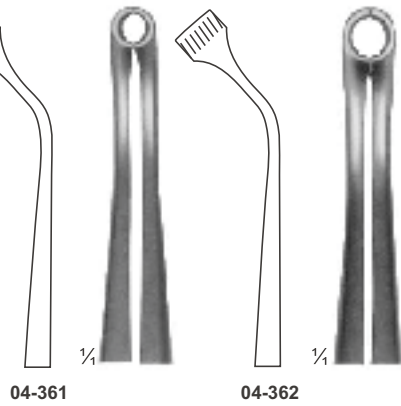
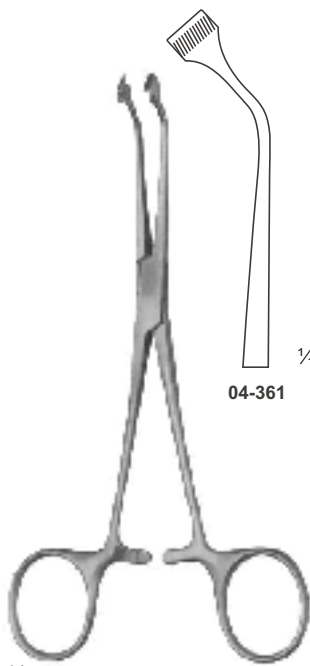

04-361

04-362

1/2

04-361 - 362
HERZ
155 mm

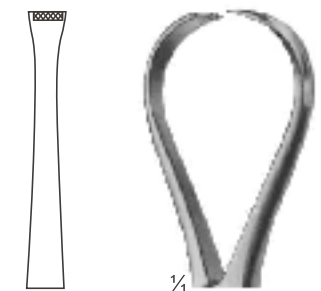

04-363

1/2

04-363
JACKSON
4 x 5 teeth
150 mm

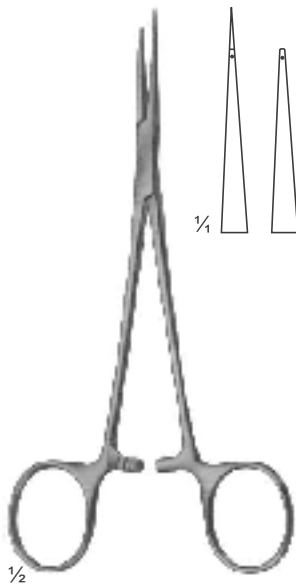

1/2

04-364
150 mm

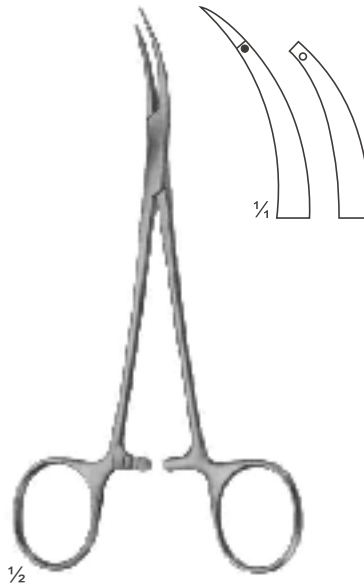

1/2

04-365
150 mm

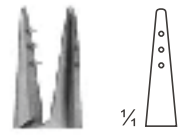

1/2

04-366
120 mm



04-367
JAGER
Tendon-and cross ligament
passing forceps
flexible shaft
275 mm



1/2

Artery Traction - and Tissue Grasping Forceps

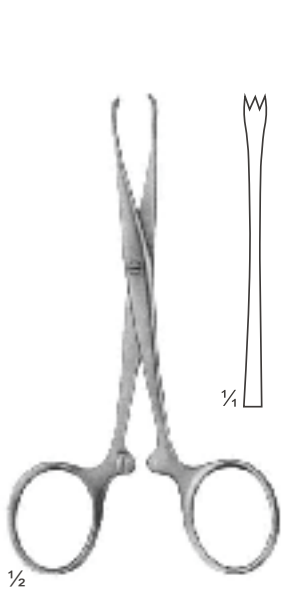

04-368
CHAPUT
2 x 3 teeth
125 mm

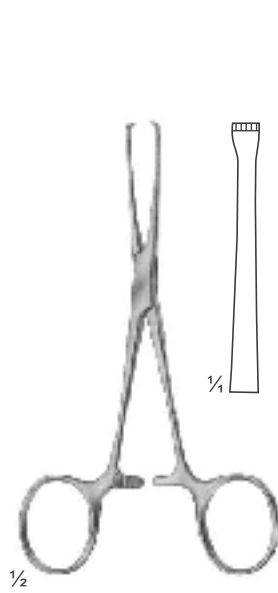

04-369
BABY-ALLIS
4 x 5 teeth
130 mm

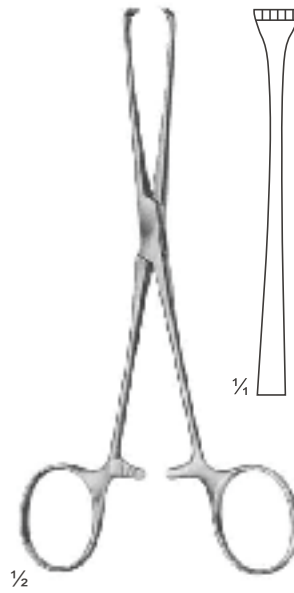

04-370
BOYS-ALLIS
5 x 6 teeth
155 mm

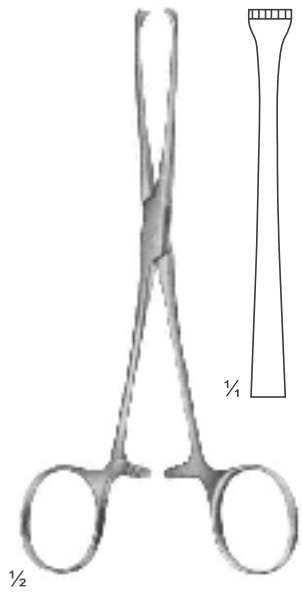

04-371
ALLIS
5 x 6 teeth
155 mm

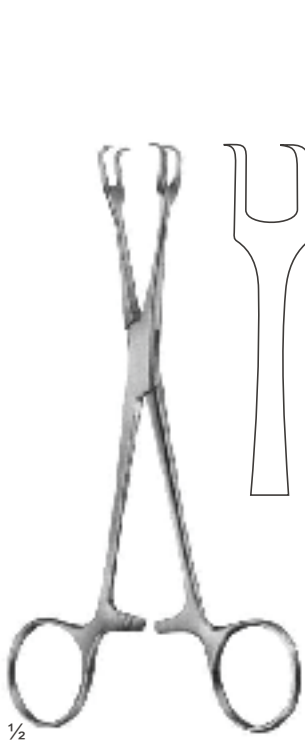

04-372
LAHEY
135 mm

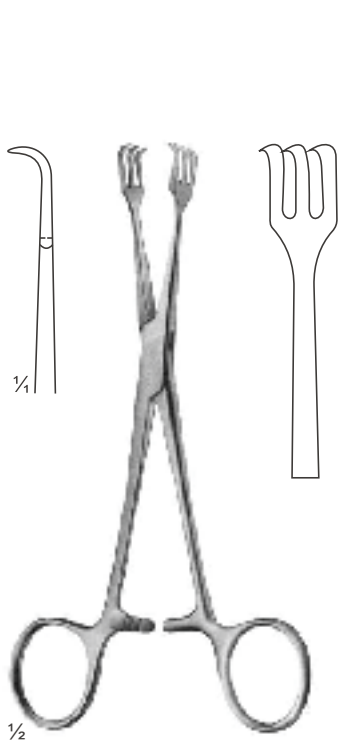

04-373
LAHEY
135 mm

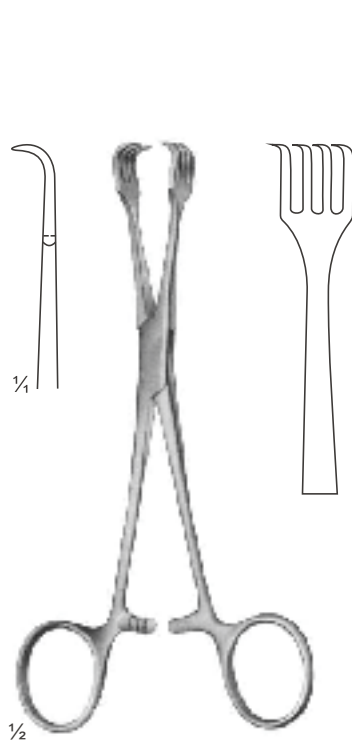

04-374
BRAUN
155 mm

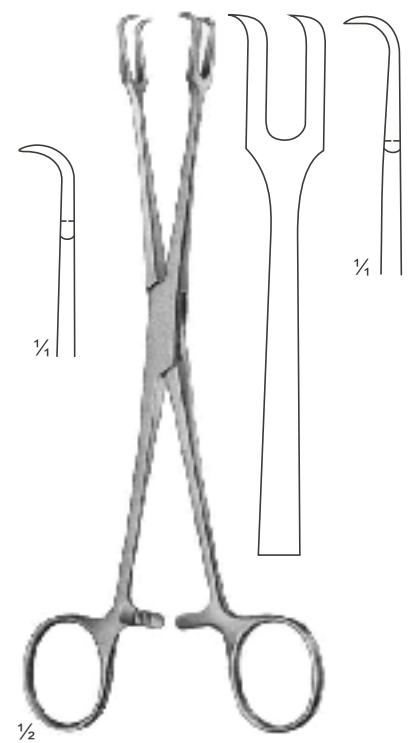

04-375
MUSEUX
200 mm

Organ - and Tissue Grasping Forceps

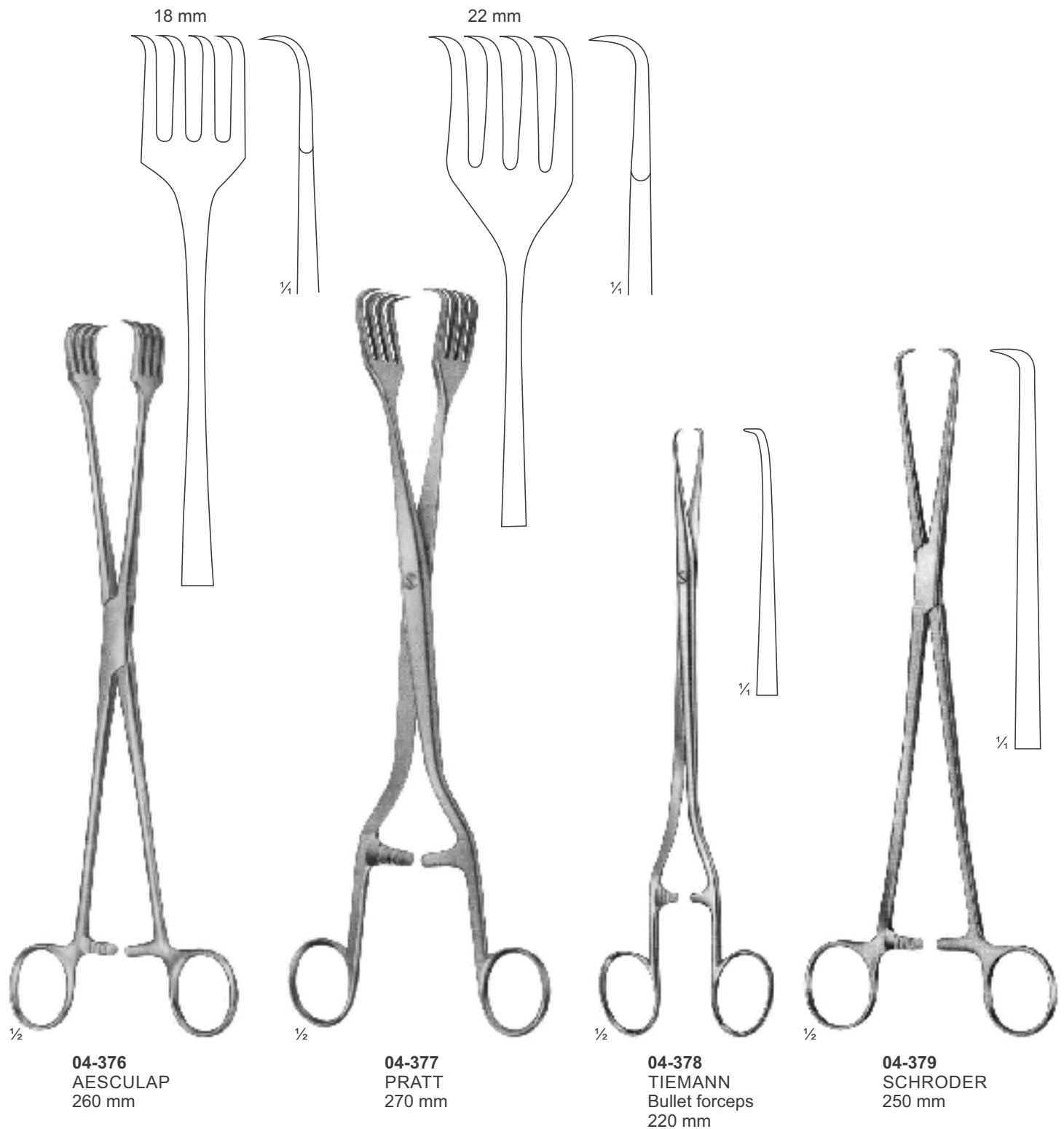

Towel Clamps

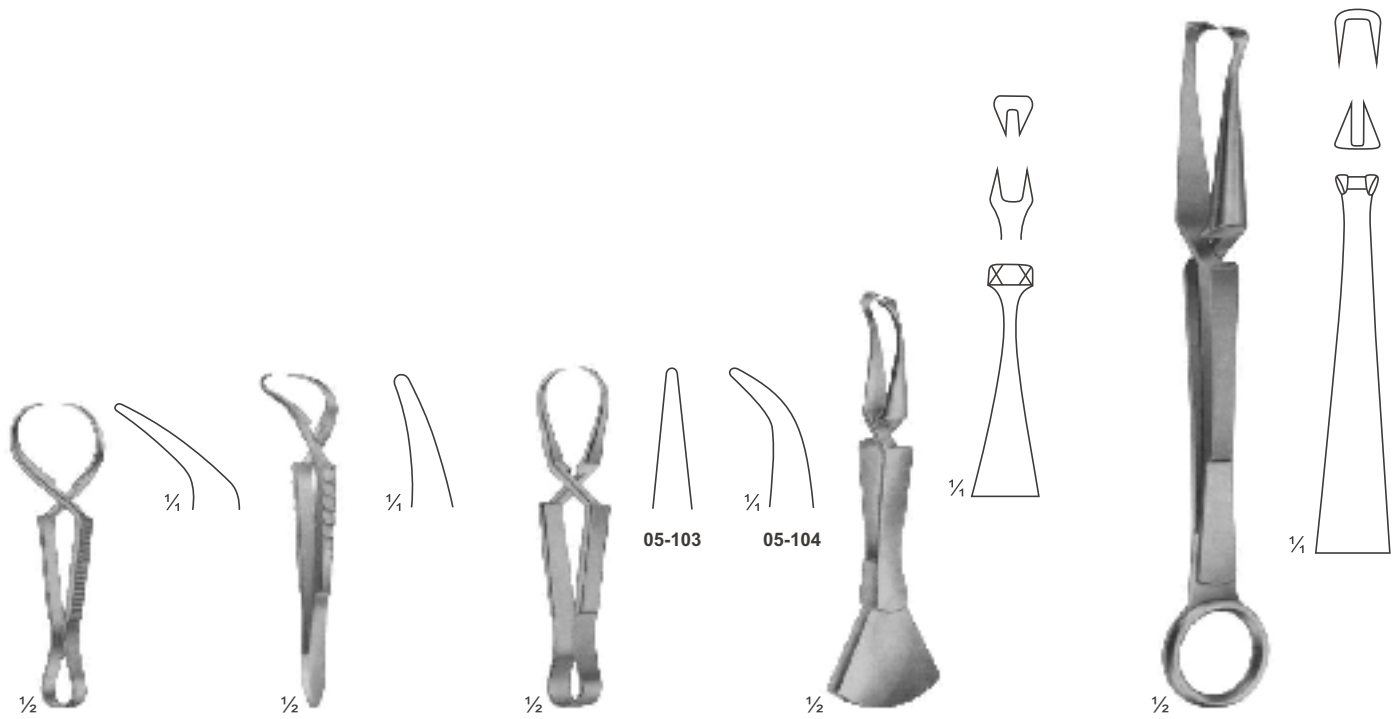

05-101
JONES
85 mm

05-102
ENGL. MOD.
85 mm

05-103 - 104
SCHAEDEL
85 mm

05-105
DOYEN
110 mm

05-106
DOYEN
180 mm

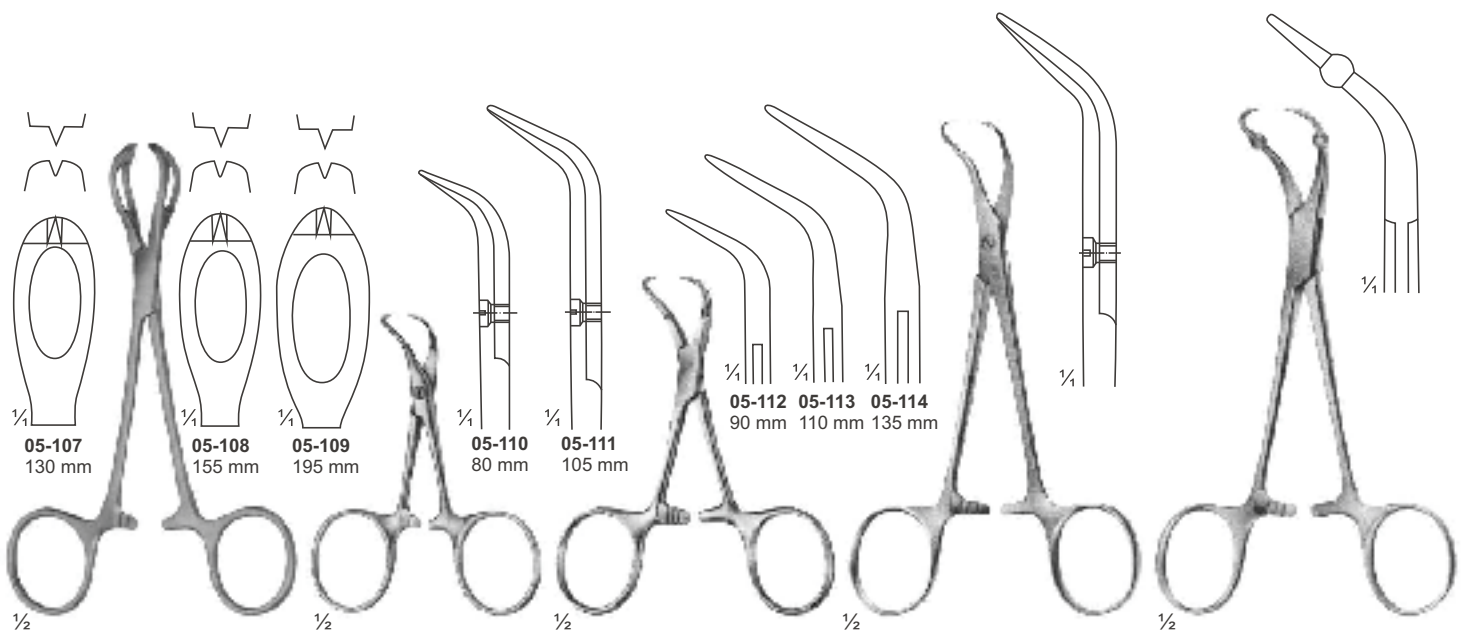

05-107
130 mm

05-108
155 mm

05-109
195 mm

05-110
80 mm

05-111
105 mm

05-112 05-113 05-114
90 mm 110 mm 135 mm

05-107 - 109
LANE

05-110 - 111
BACKHAUS

05-112 - 114
BACKHAUS

05-115
BACKHAUS-KOCHER
135 mm

05-116
ROEDER
135 mm

Towel Clamps

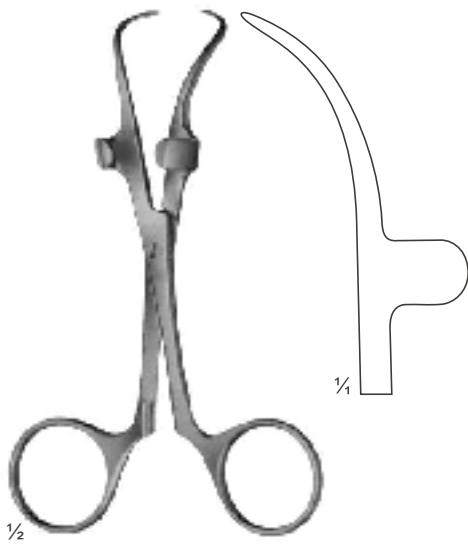

05-117
ROBIN
with holders for tubing
up to 13 mm
135 mm

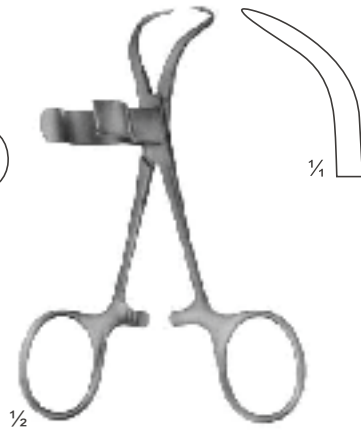

05-118
with clip for tubing
up to 15 mm
110 mm

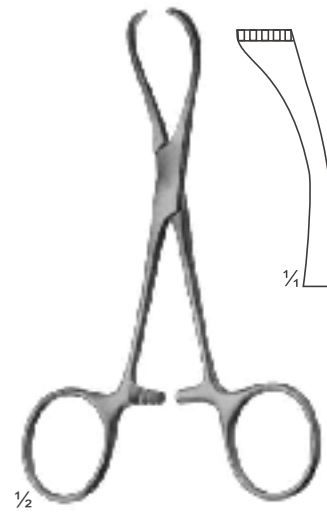

05-119
LORNA
non perforating
130 mm

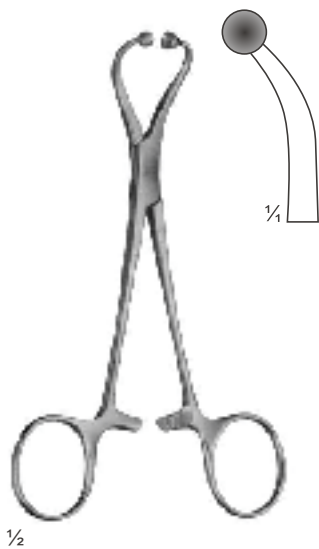

05-120
for paper cloths
140 mm



05-121
BUNT
105 mm



05-122
MAYO
140 mm

Muller Vessel Clips and Bulldog Clamps

Closing force

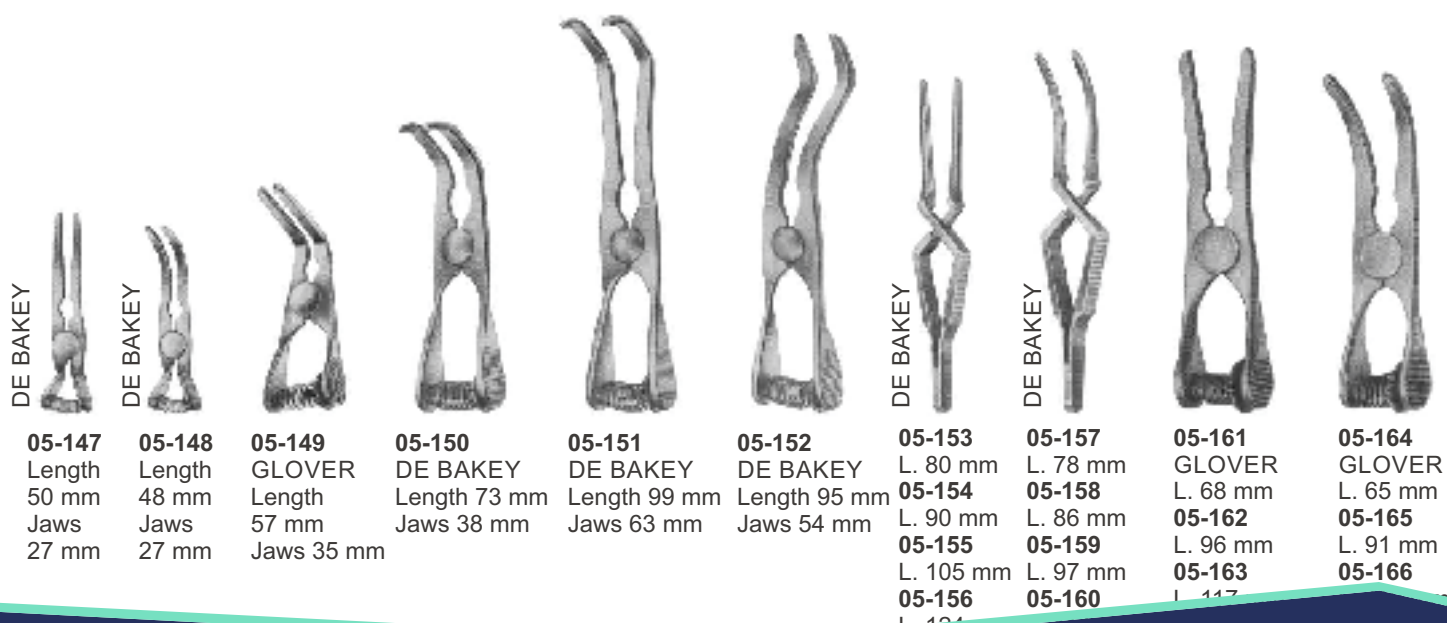
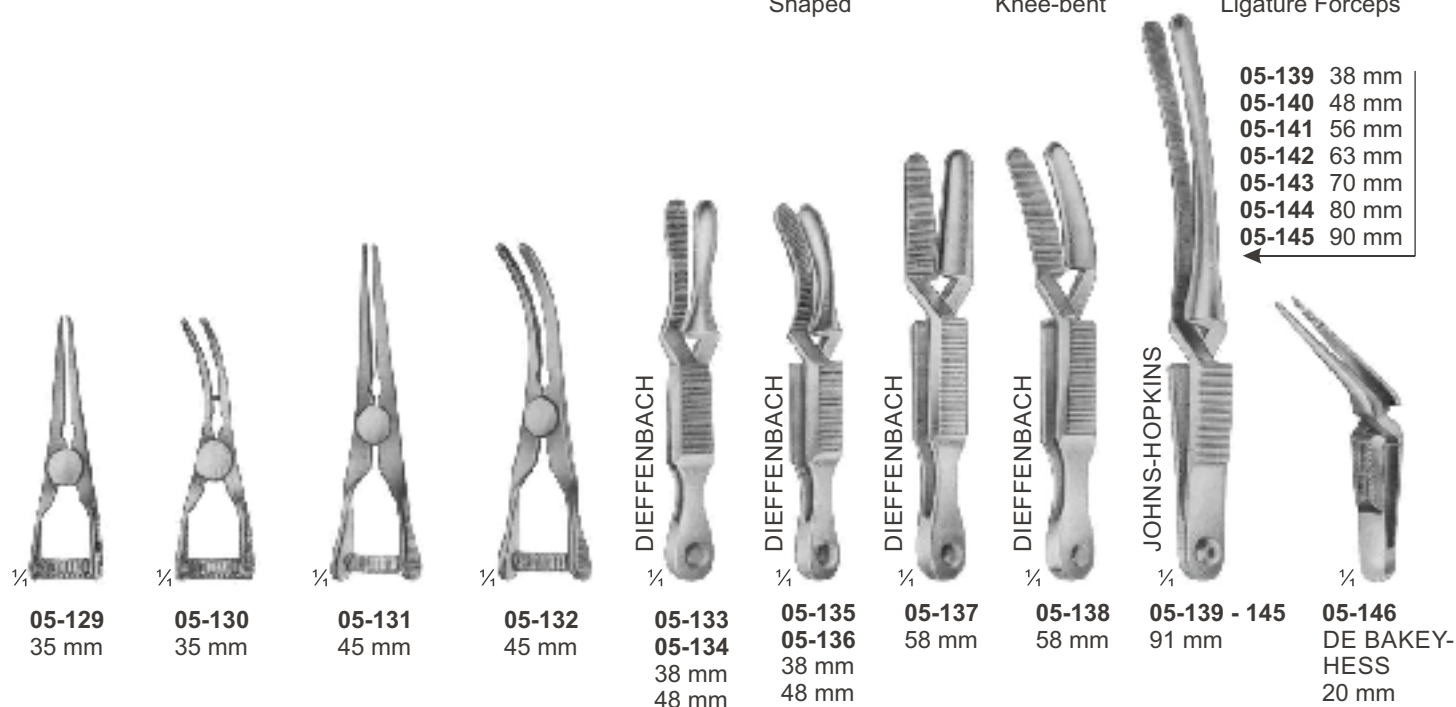
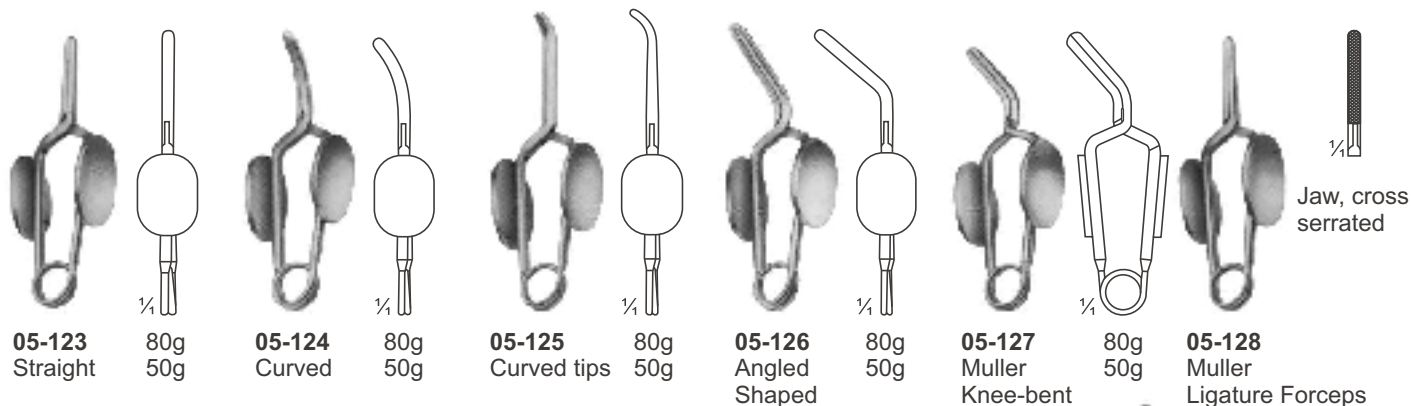

Delicate Haemostatic Forceps



06-101
CARREL
85 mm

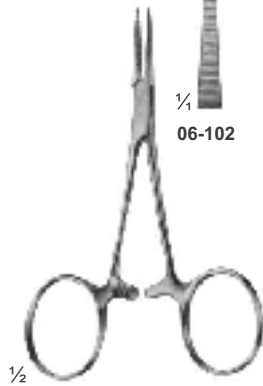

06-102 - 105
BABY-MOSQUITO
(HARTMANN)
100 mm

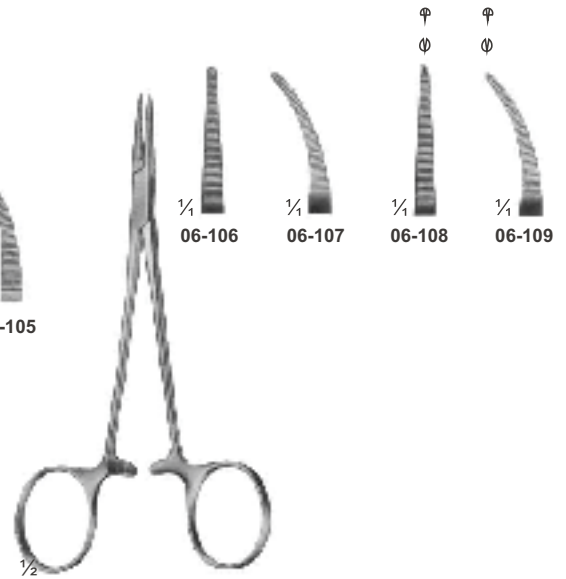

06-106 - 109
MICRO-HALSTED
125 mm



06-110 - 113
HALSTED-MOSQUITO
125 mm

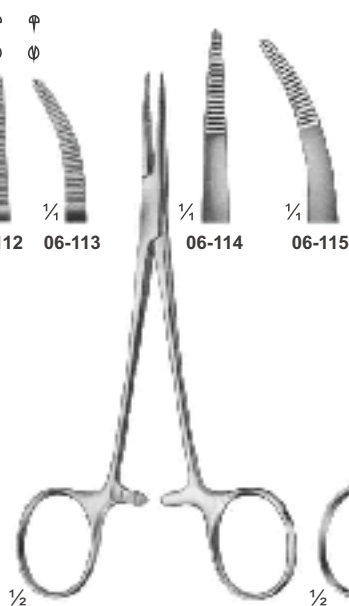

06-114 - 115
PROVIDENCE-HOSPITAL
140 mm

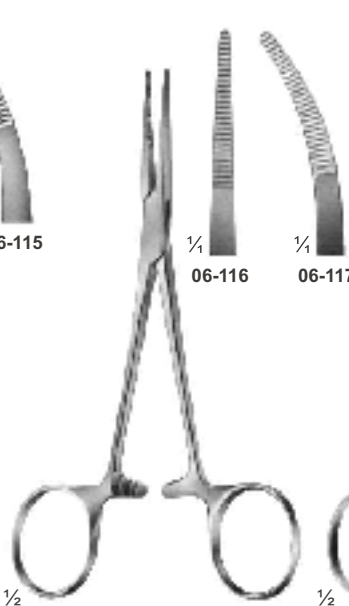

06-116 - 117
KELLY
140 mm

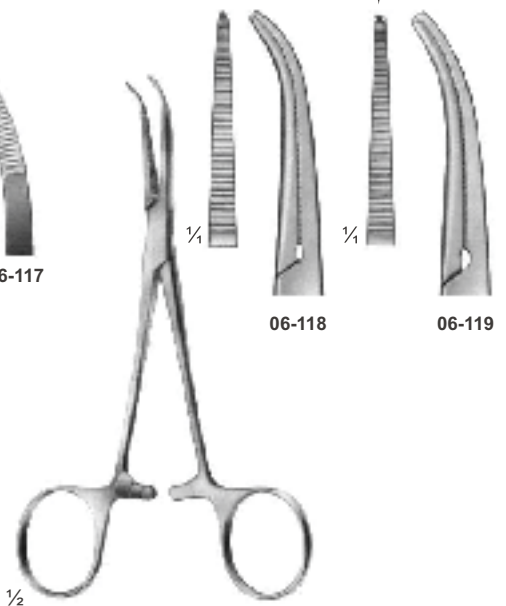

06-118 - 119
DANDY
Curved sideways
140 mm

Delicate Haemostatic Forceps

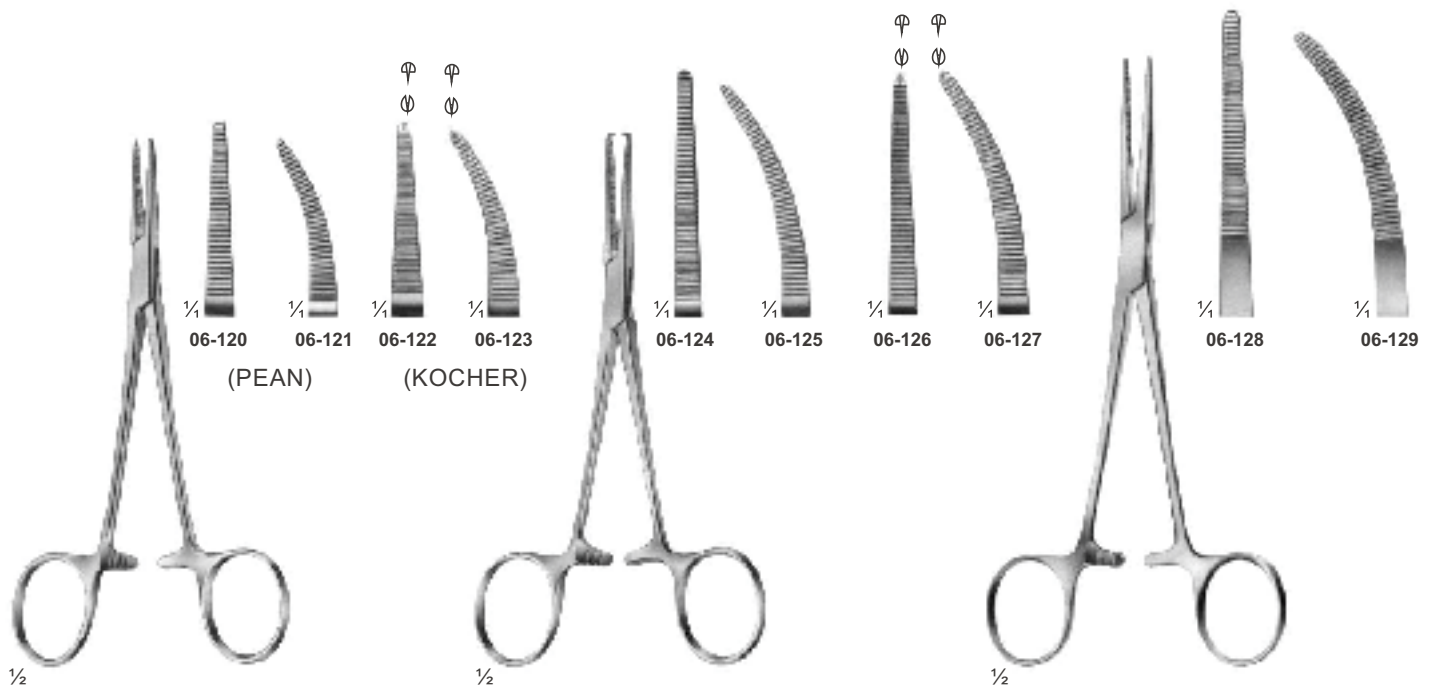

06-120 - 123
BABY-CRILE
140 mm

06-124 - 127
CRILE
140 mm

06-128 - 129
RANKIN
160 mm

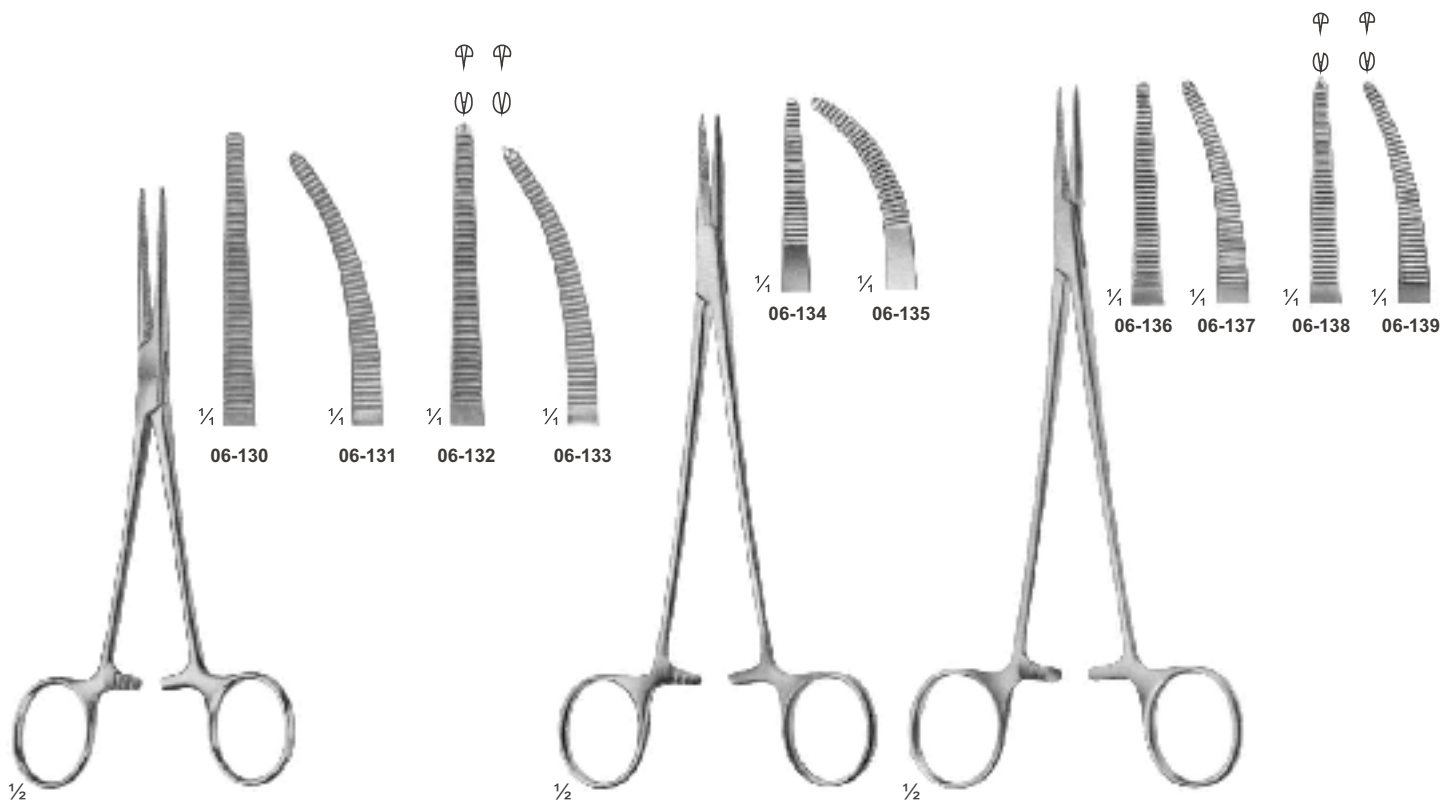

06-130 - 133
CRILE
160 mm

06-134 - 135
ADSON
185 mm

06-136 - 139
HALSTED
185 mm

Delicate Haemostatic Forceps

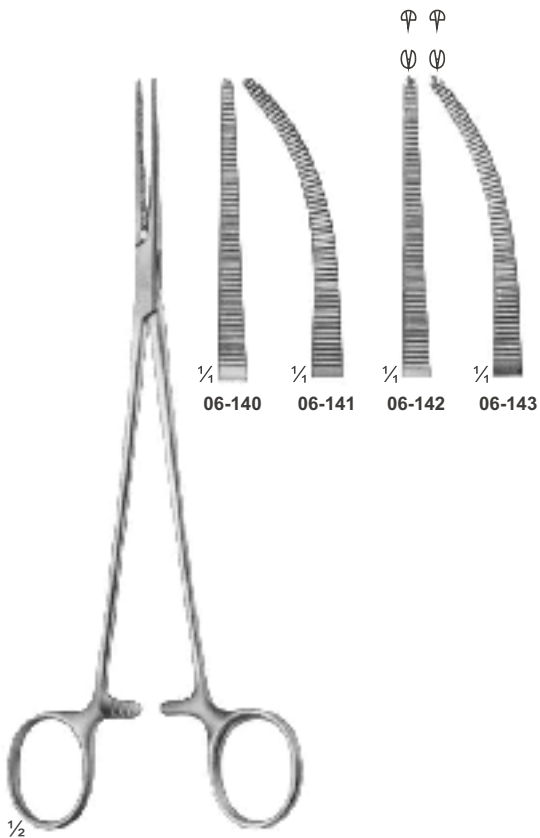

06-140 - 143
HALSTED-MOSQUITO
200 mm

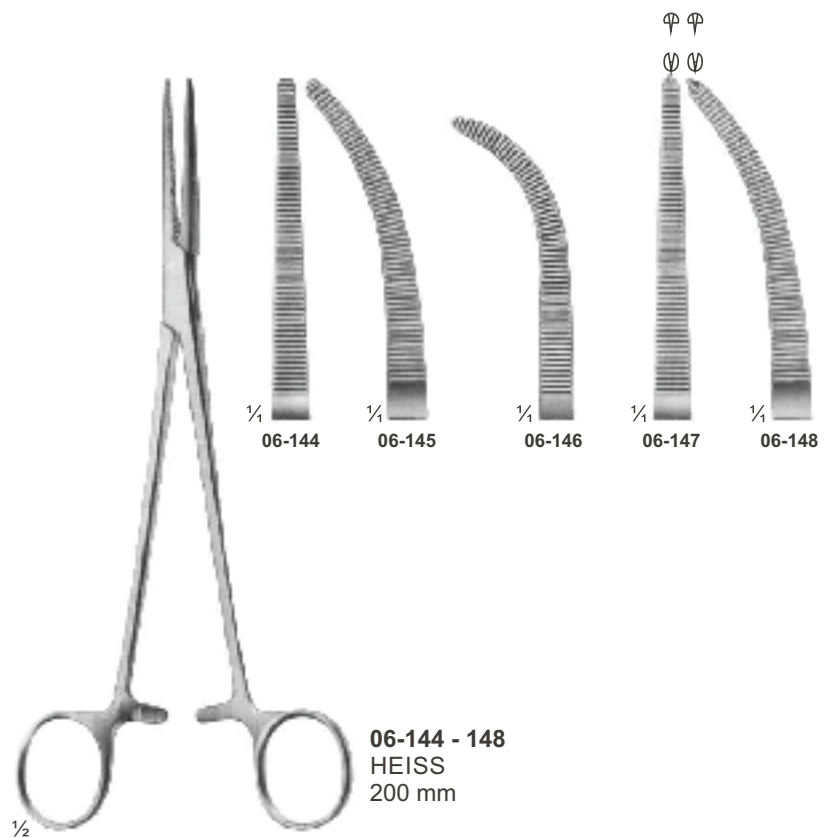

06-144 - 148
HEISS
200 mm

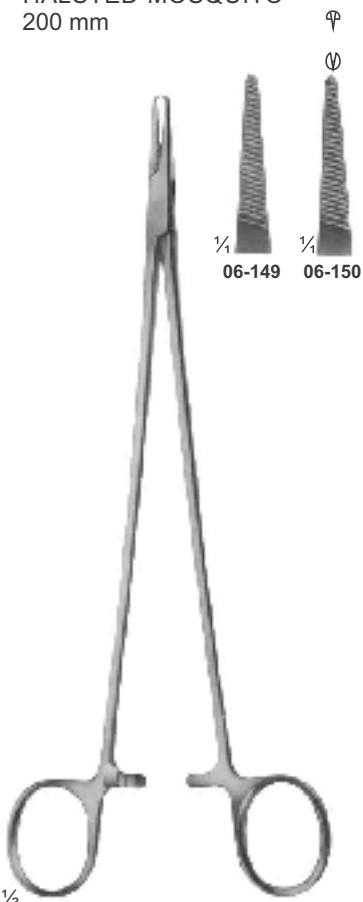

06-149 - 150
HALSTED
215 mm

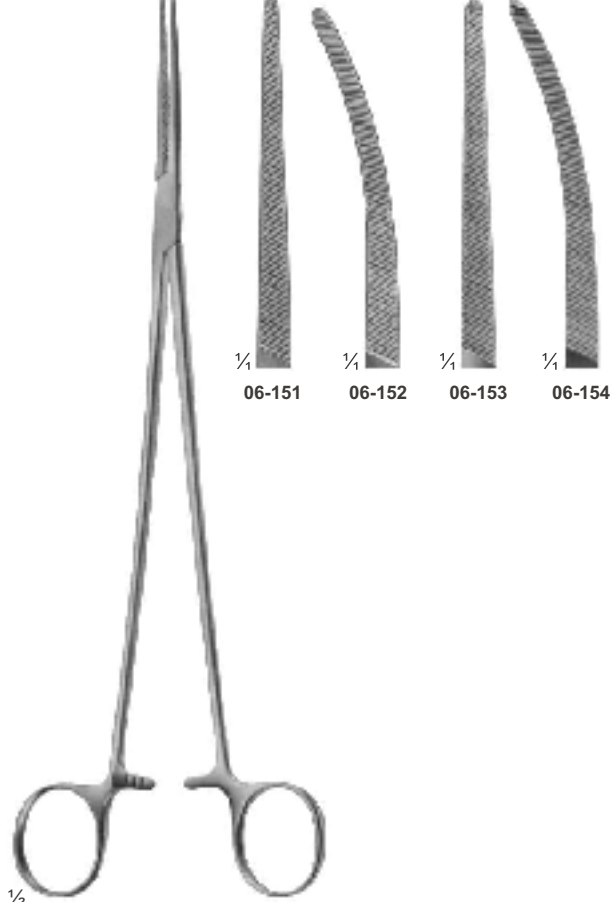

06-151 - 154
BENGOLEA
245 mm

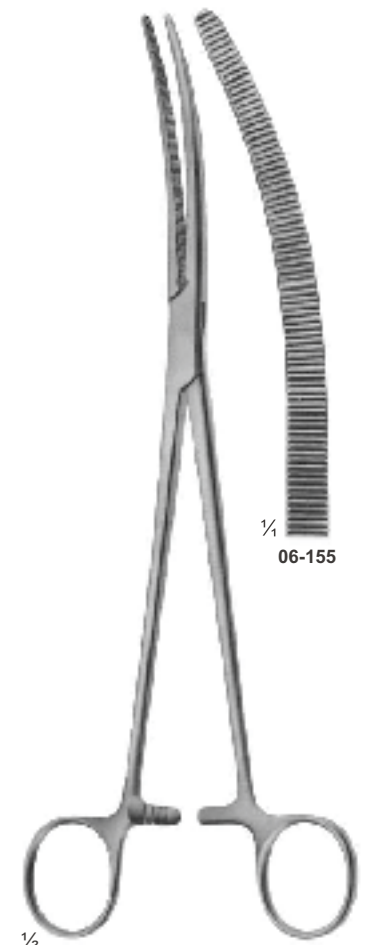

06-155
CRAFOORD
245 mm

Haemostatic Forceps

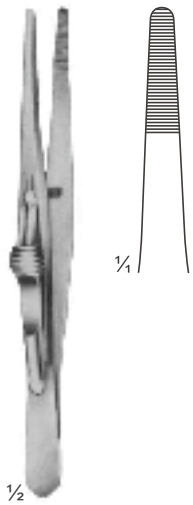

06-156
FRICKE
Artery forceps
130 mm

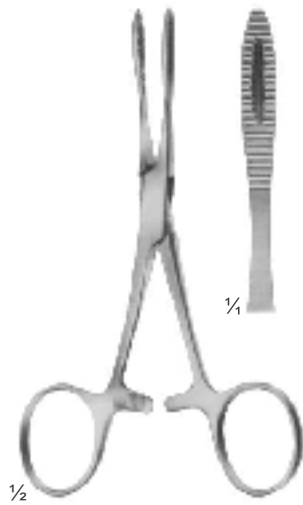

06-157
KRONLEIN
130 mm

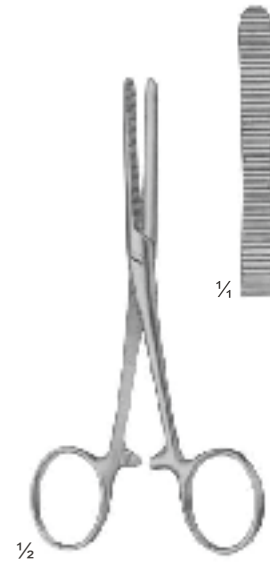

06-158
PEAN
125 mm



06-159 - 160
PEAN



06-160
140 mm

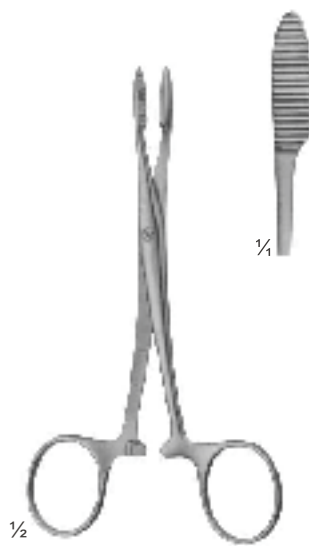

06-161
PEAN

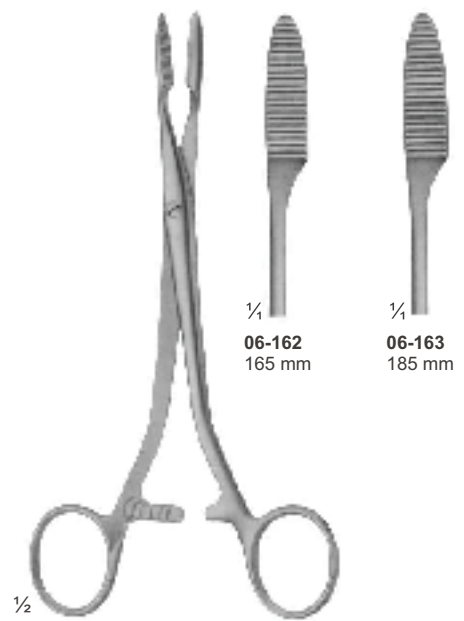

06-162 - 163
PEAN

06-162
165 mm

06-163
185 mm

Haemostatic Forceps

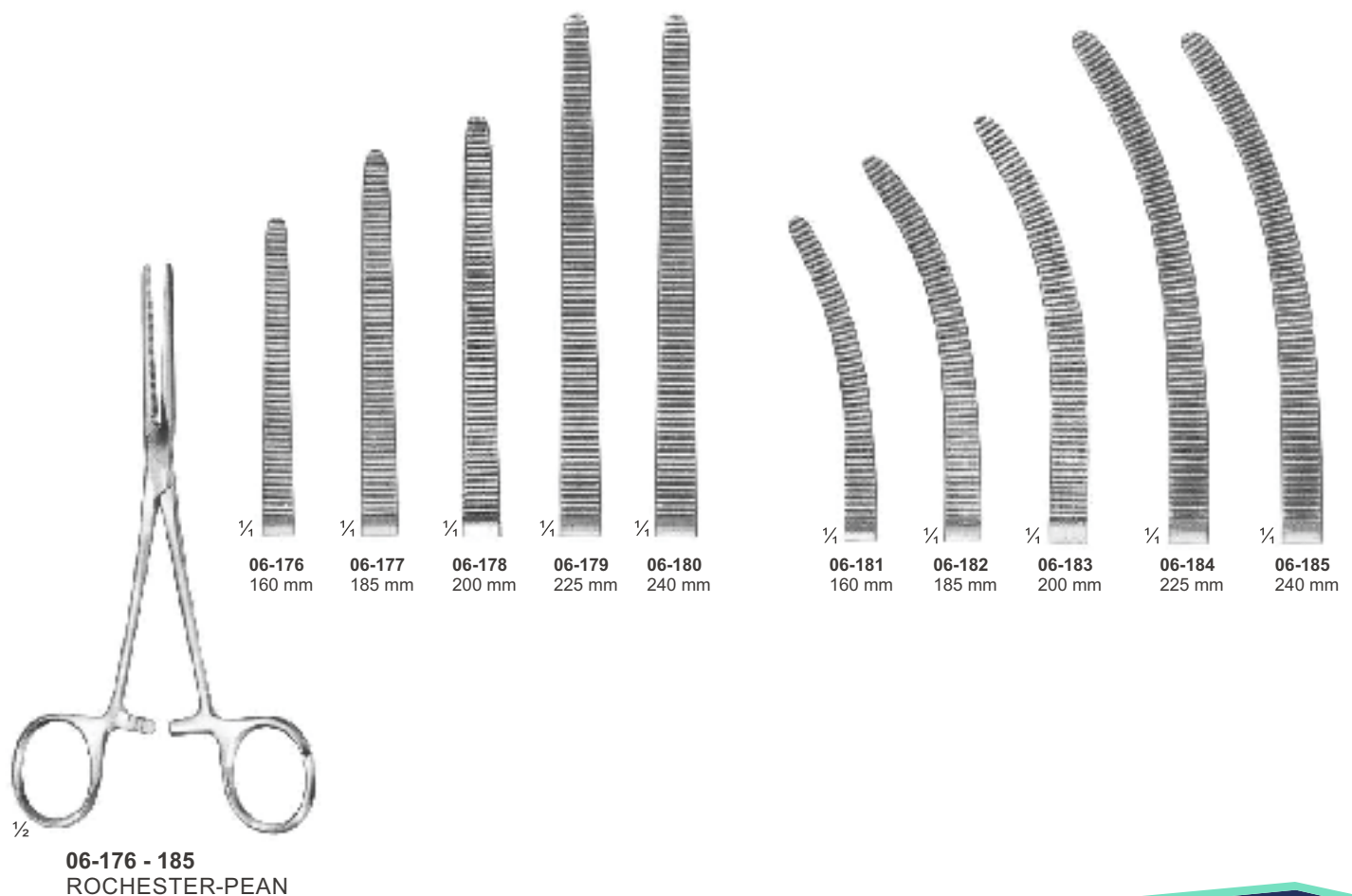
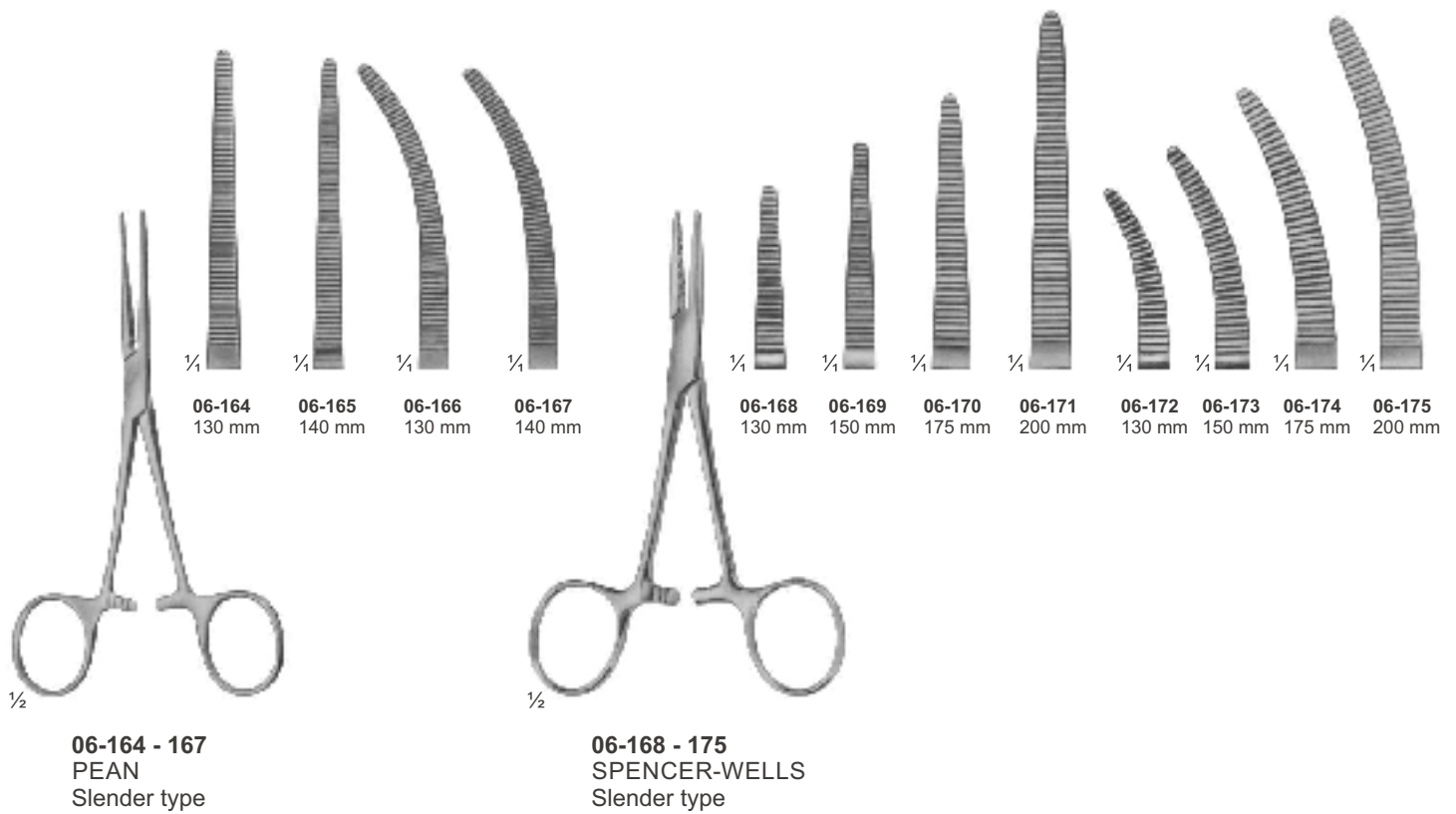

Haemostatic Forceps

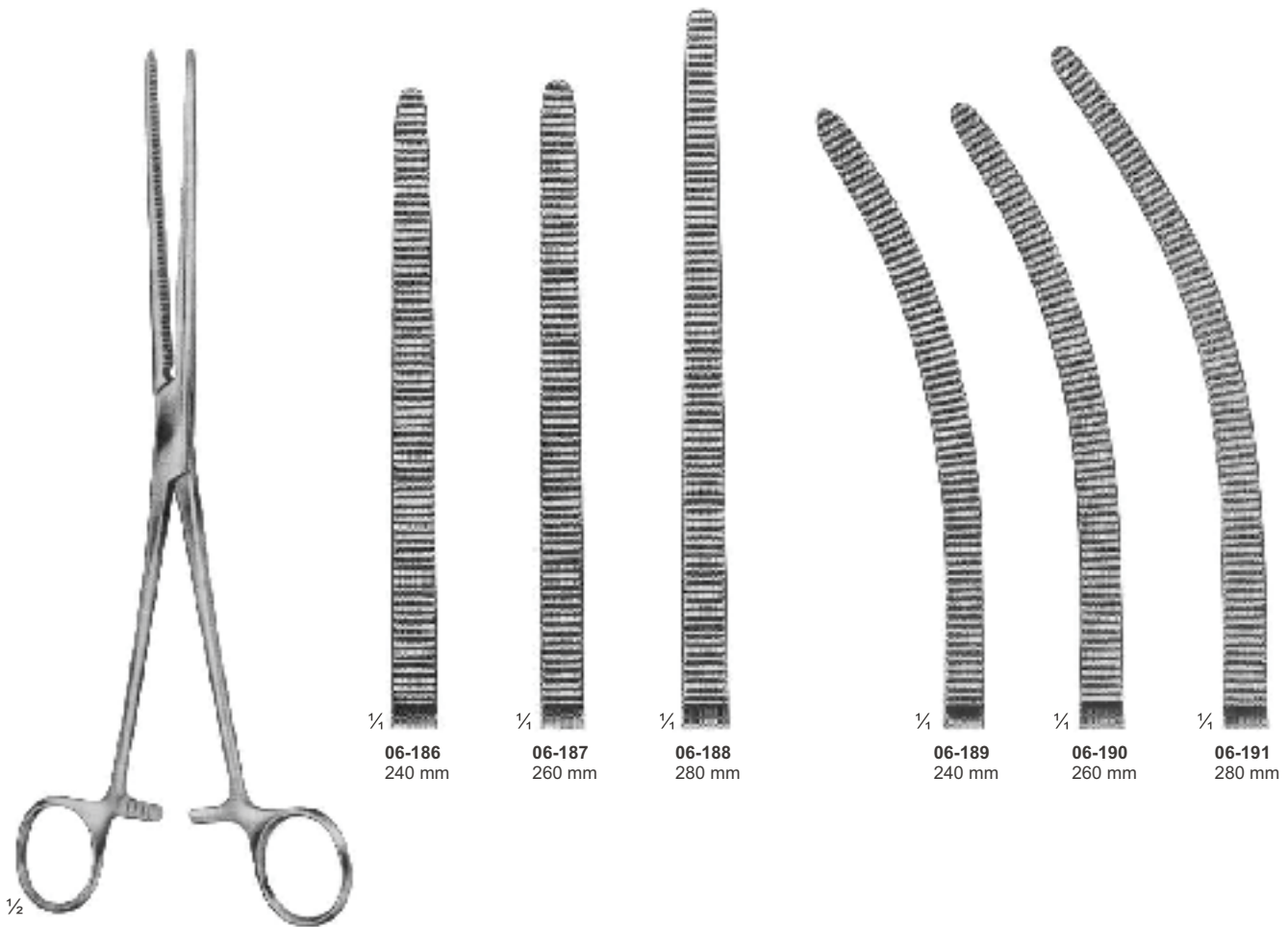

06-186 - 191
PEAN

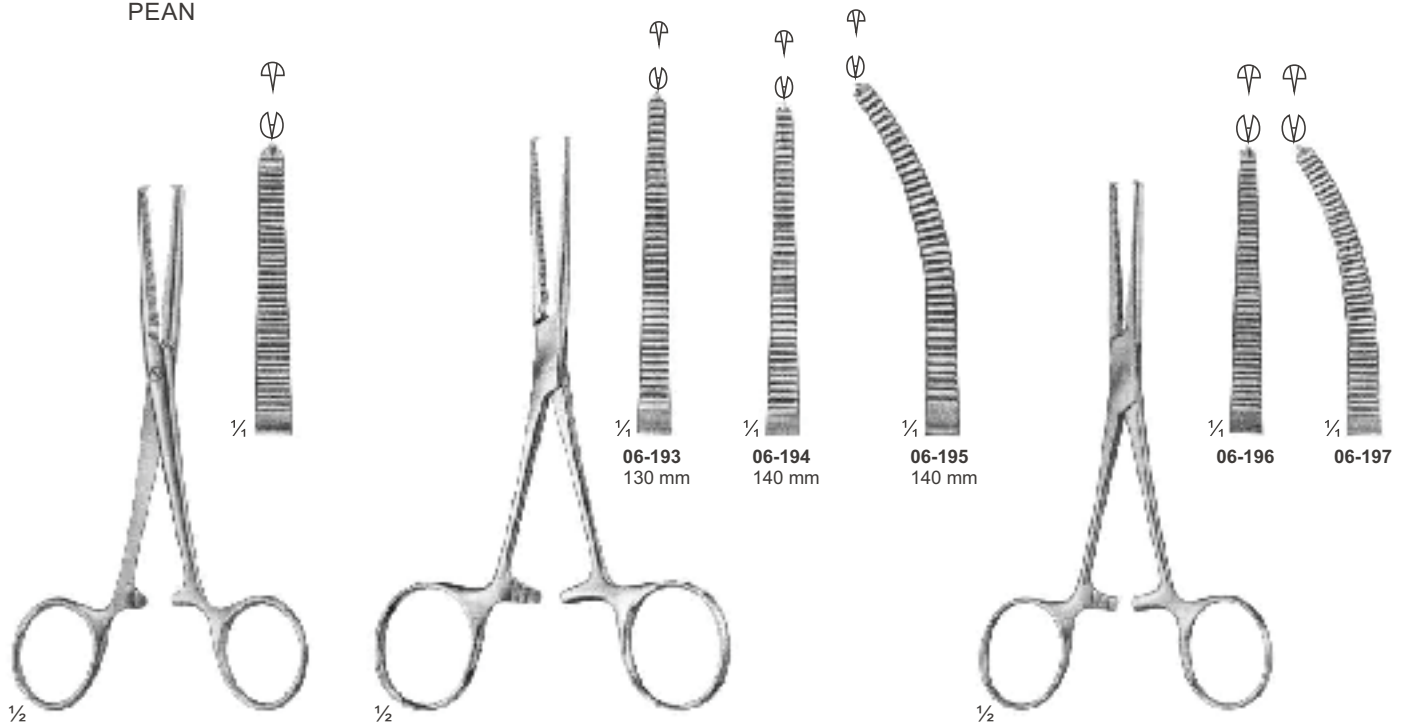

06-192
KOCHER
Strong Pattern
145 mm

06-193 - 195
KOCHER

06-196 - 197
ROCHESTER-OGHSNER
140 mm

Haemostatic Forceps

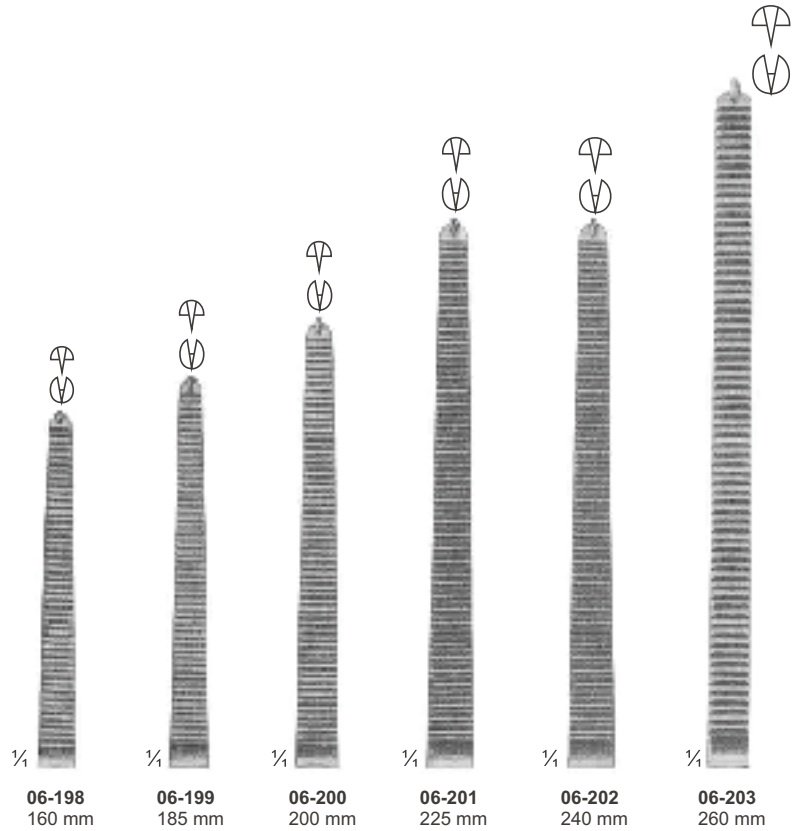

06-198 - 209
KOCHER-OCHSNER

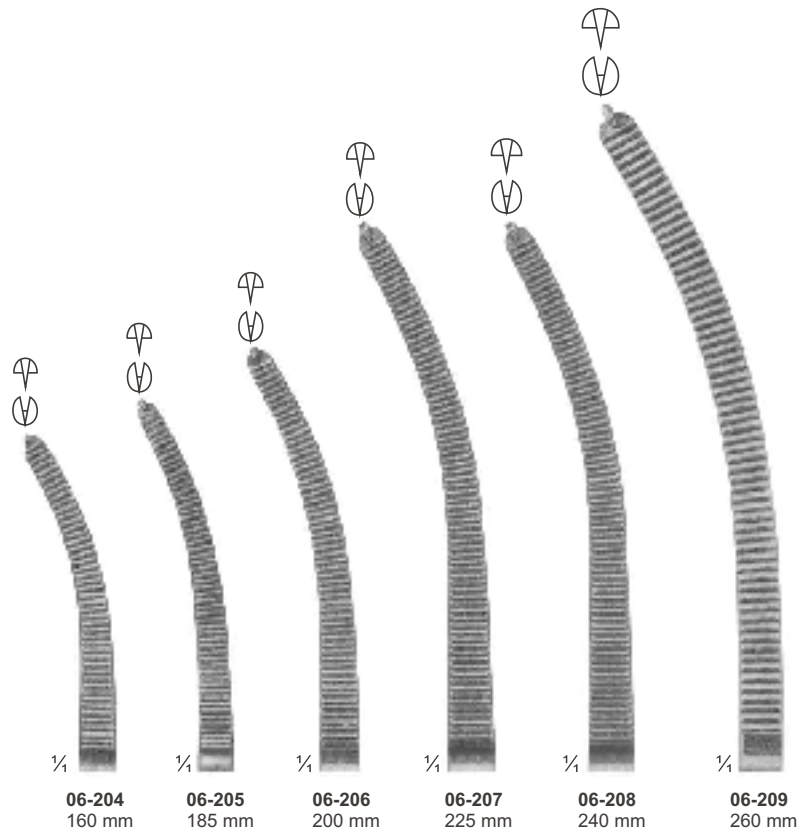

Haemostatic Forceps, Special Pattern, Tonsil Forceps

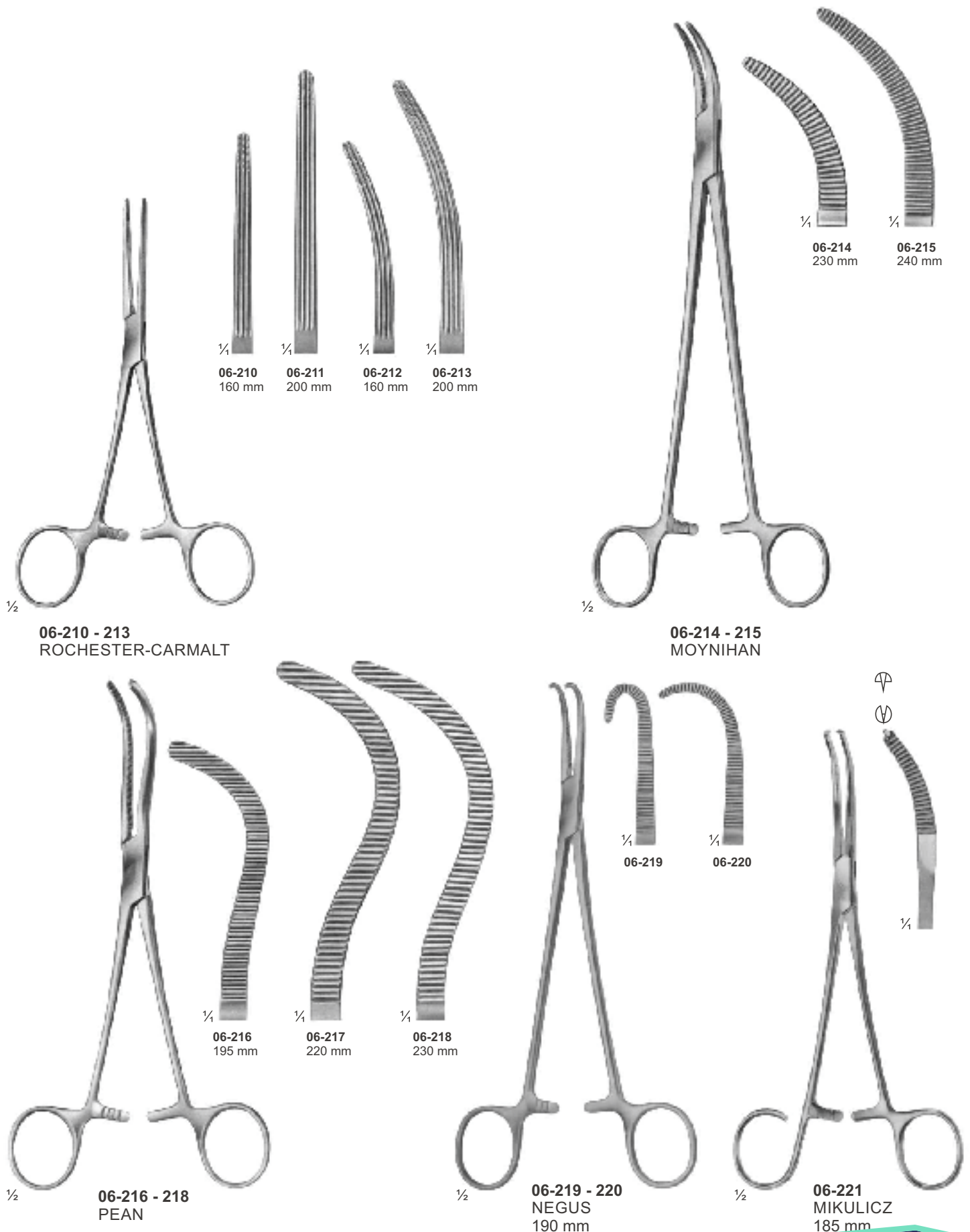

Dissecting- and Ligature Forceps

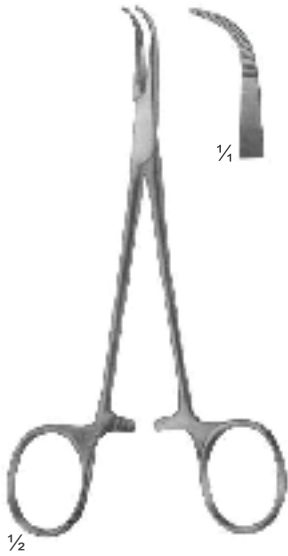

06-222
MICRO-ADSON
140 mm



06-223
BABY-OVERHOLT
135 mm

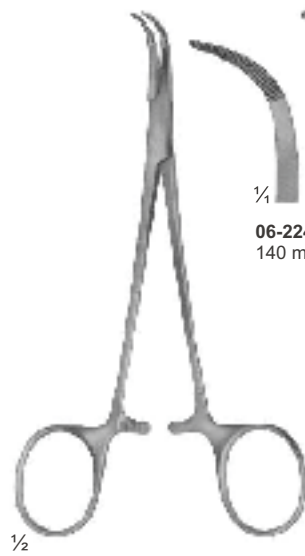

06-224 - 225
BABY-MIXTER

06-224
140 mm

06-225
180 mm

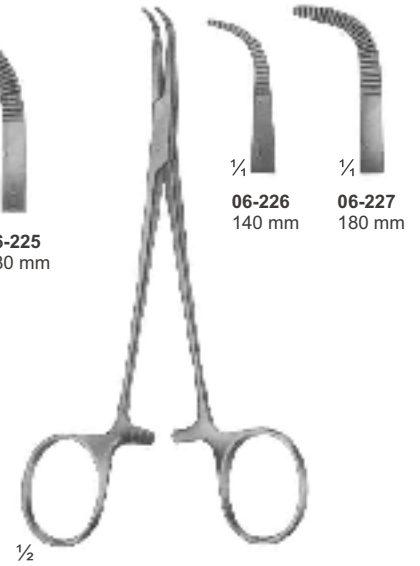

06-226 - 227
BABY-ADSON

06-226
140 mm

06-227
180 mm



06-228
NISSEN

06-228
185 mm



06-229 - 230
YASARGIL
195 mm

06-229

06-230

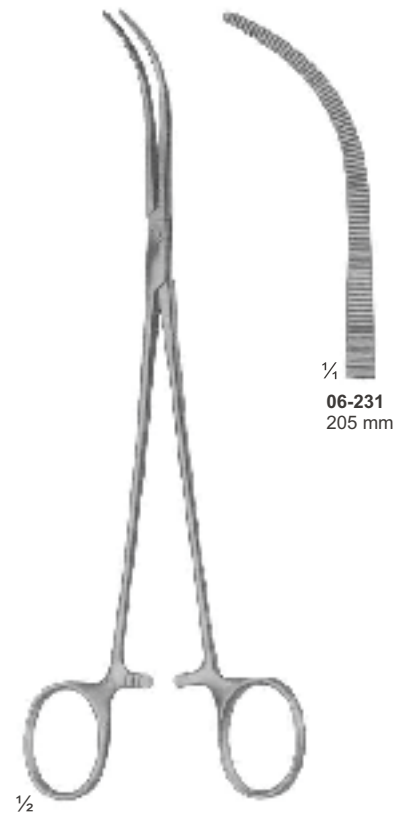

06-231
OVERHOLT-MIXTER

06-231
205 mm

Dissecting- and Ligature Forceps

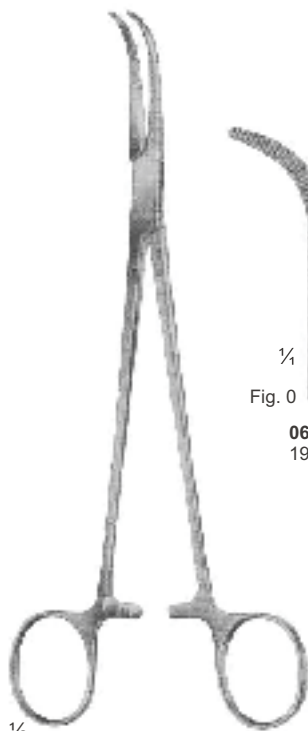

1/2

06-232 - 243
OVERHOLT-GEISSENDOERFER

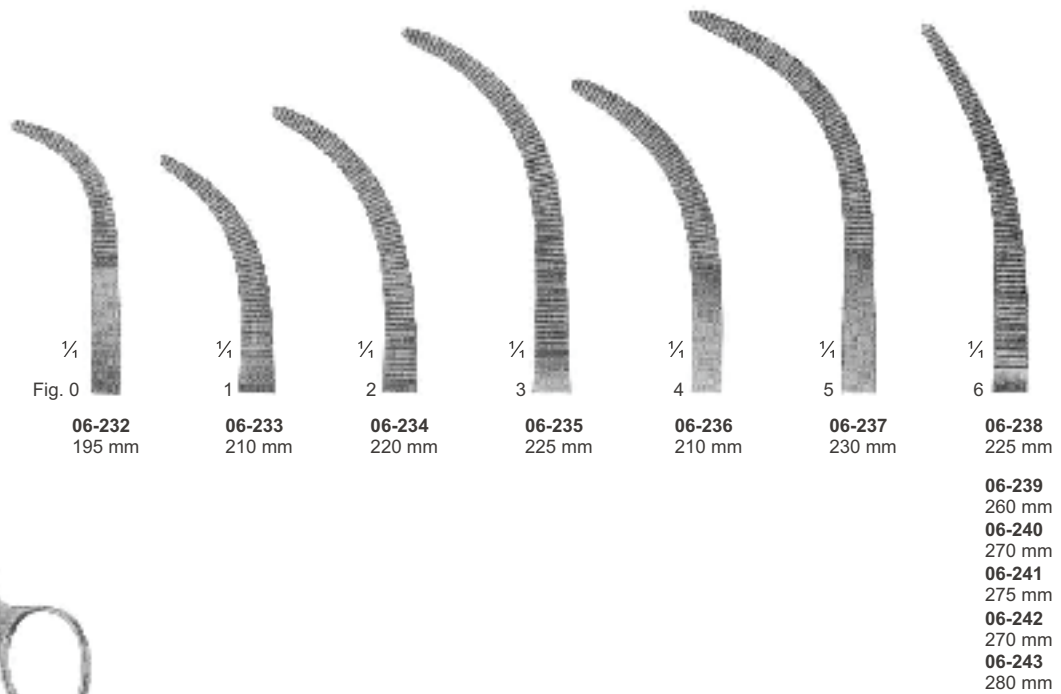

06-239
260 mm
06-240
270 mm
06-241
275 mm
06-242
270 mm
06-243
280 mm



1/2

06-244 - 251
OVERHOLT
fine pattern

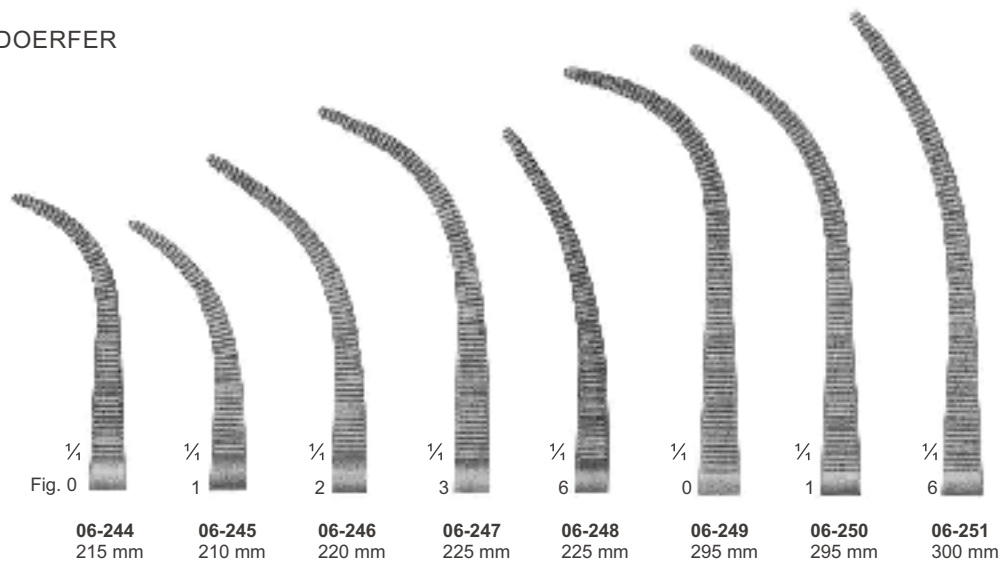

Dissecting- and Ligature Forceps

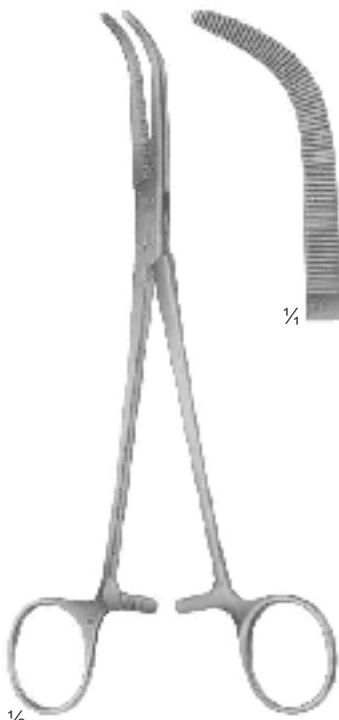

$\frac{1}{2}$
06-252
MIXTER-O'SHAUGNESSY
190 mm



$\frac{1}{2}$
06-253
HEISS
195 mm

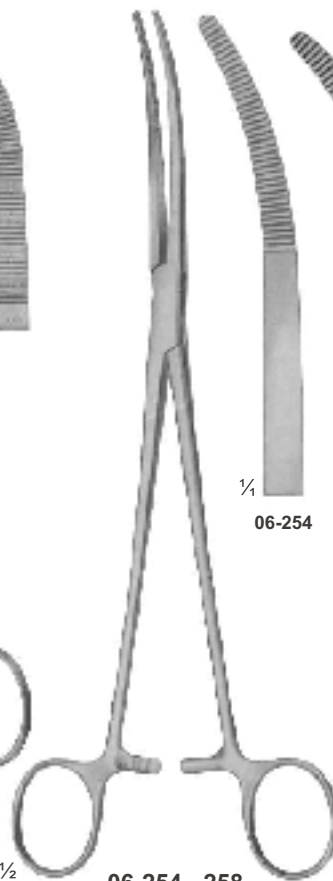

$\frac{1}{2}$
06-254 - 258
RUMEL
240 mm

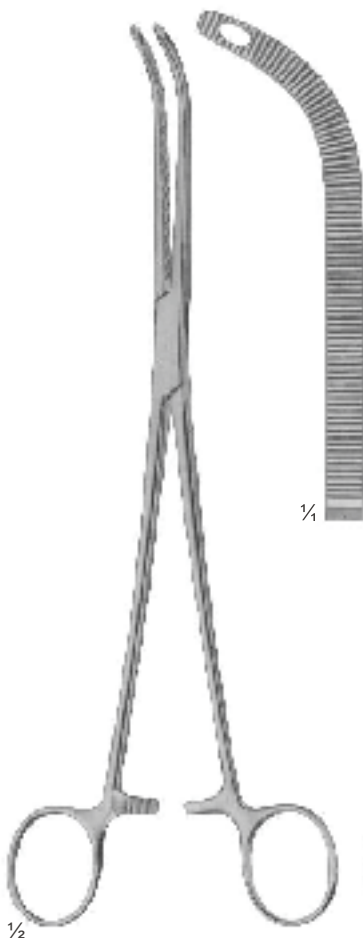

$\frac{1}{2}$
06-259
FINOCHIETTO
245 mm



$\frac{1}{2}$
06-260
MIXTER
230 mm



$\frac{1}{3}$
06-261
LAWRENCE
270 mm

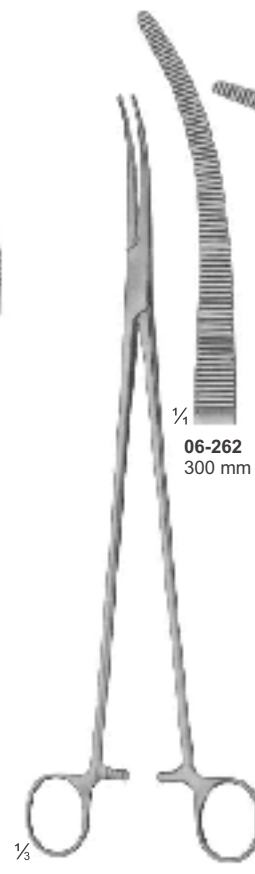

$\frac{1}{3}$
06-262 - 263
ZENKER

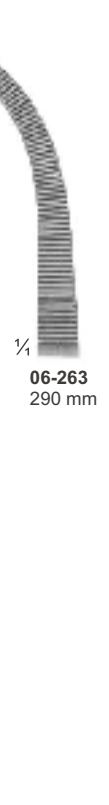

$\frac{1}{4}$
06-263
290 mm

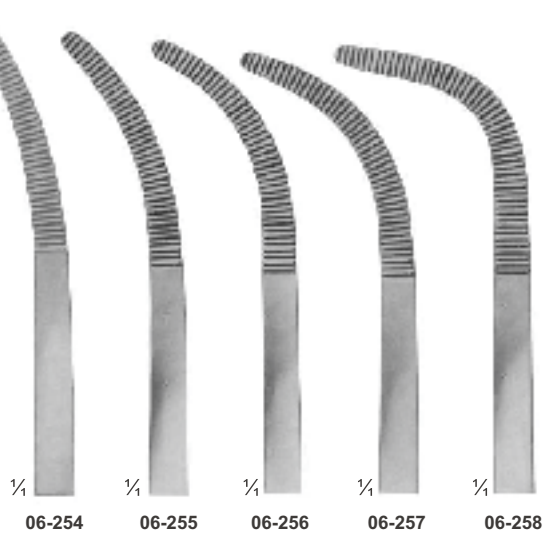

$\frac{1}{4}$ **06-254** $\frac{1}{4}$ **06-255** $\frac{1}{4}$ **06-256** $\frac{1}{4}$ **06-257** $\frac{1}{4}$ **06-258**

Dissecting- and Ligature Forceps

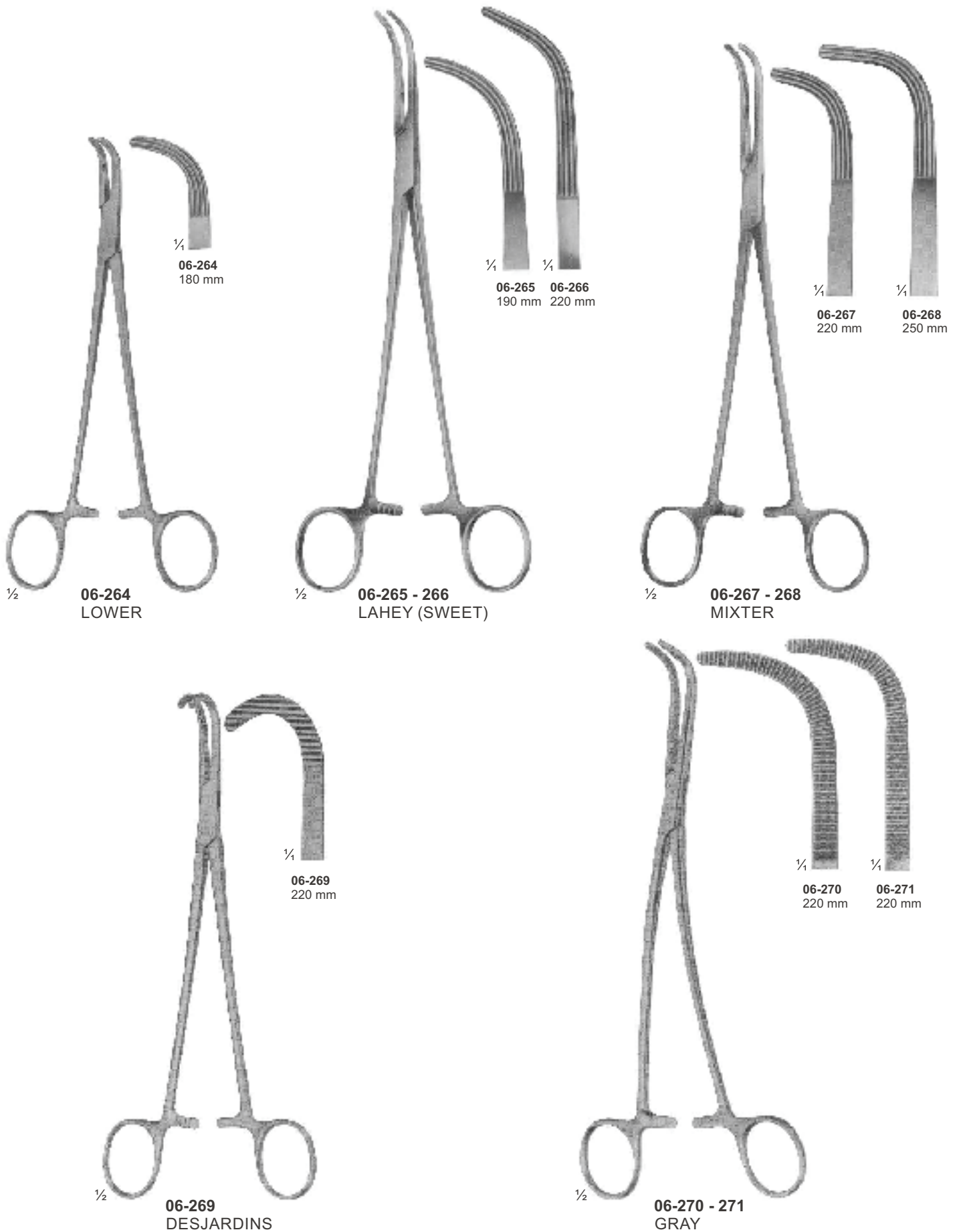

Peritoneum Forceps

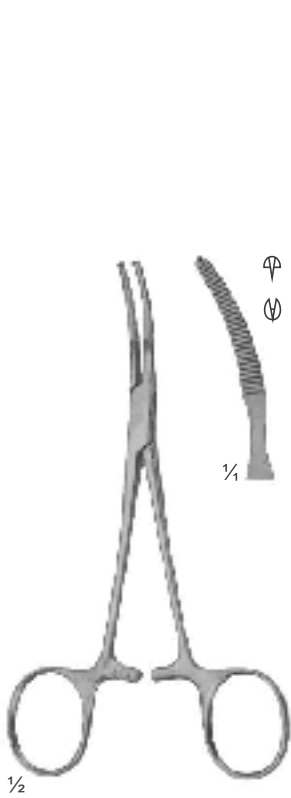

06-272
BABY-MIKULICZ
140 mm

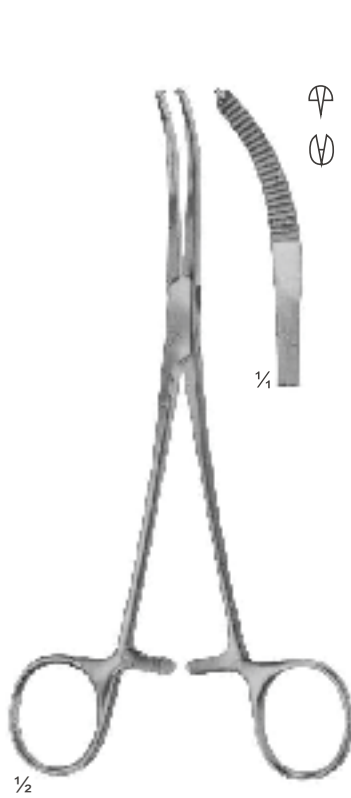

06-273
MIKULICZ
185 mm

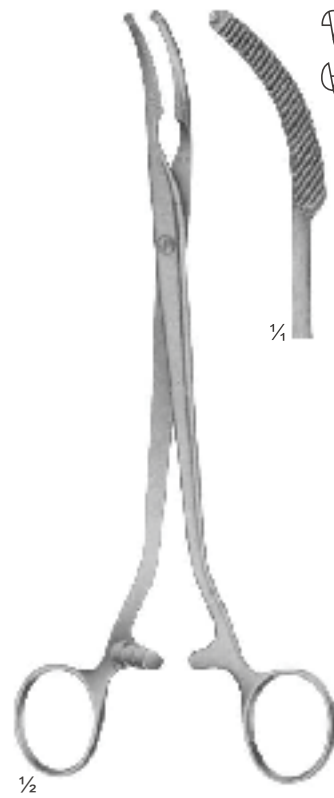

06-274
MIKULICZ
205 mm

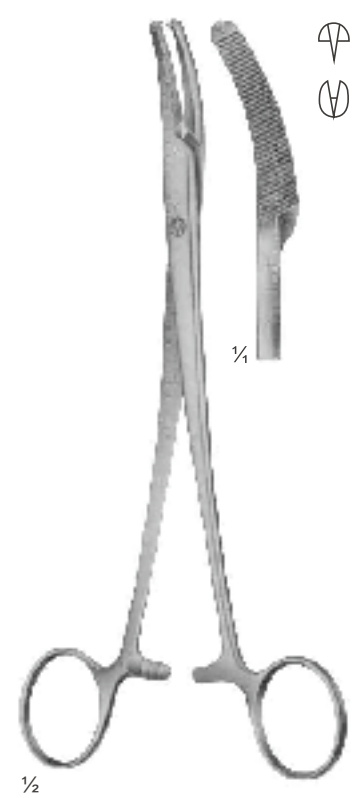

06-275
MIKULICZ
200 mm

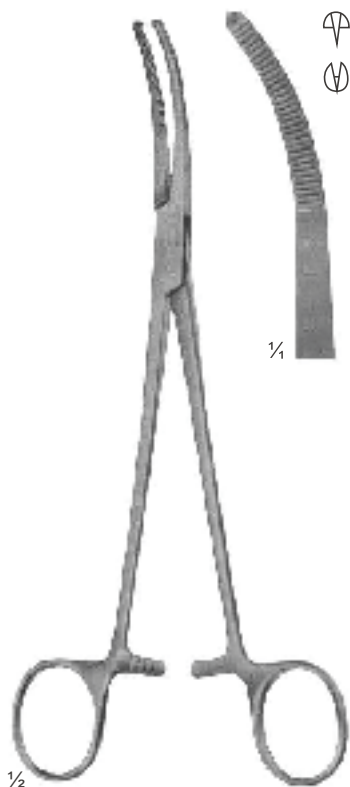

06-276
MIKULICZ
205 mm

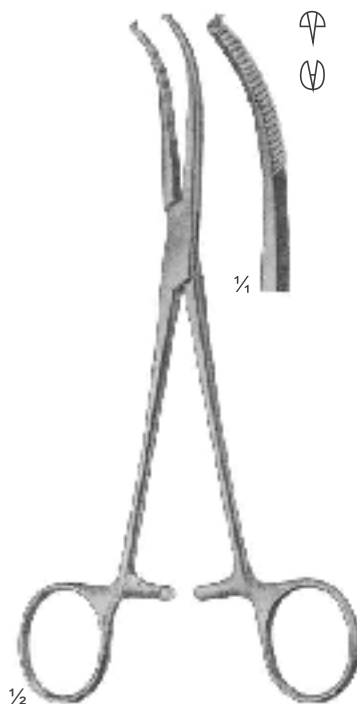

06-277
MIKULICZ
185 mm

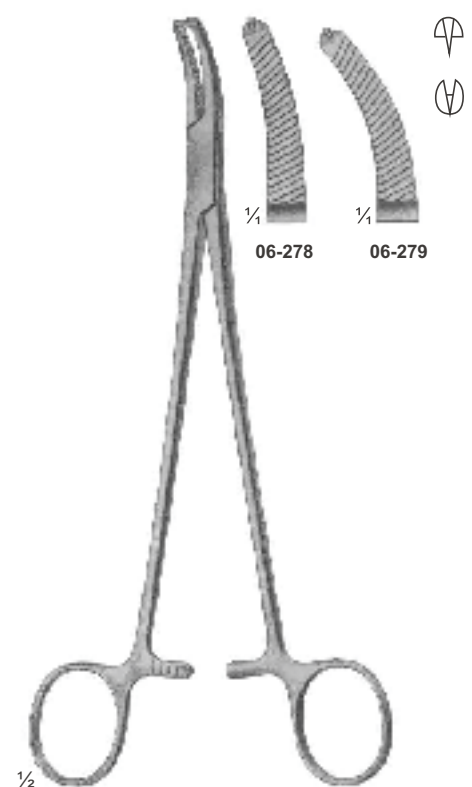

06-278 - 279
FAURE
205 mm

Hysterectomy Forceps

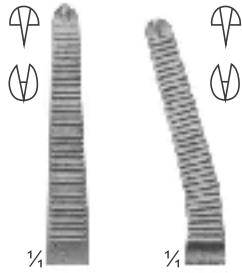
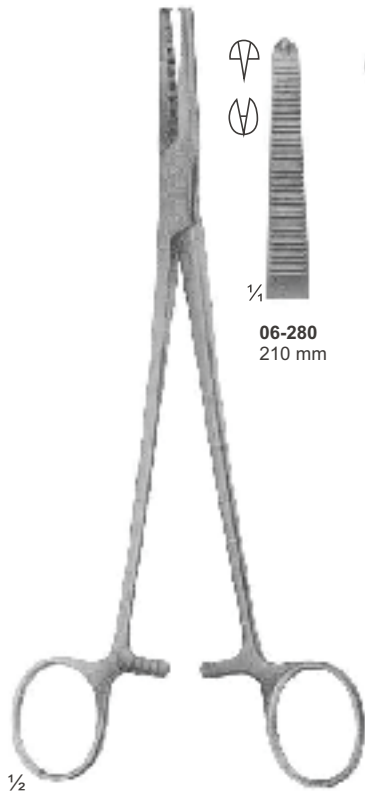

06-280
210 mm

06-281
205 mm

06-280 - 281
PHANEUF

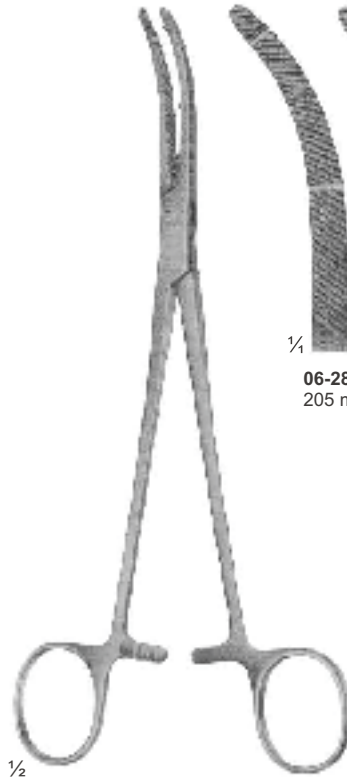

06-282
205 mm

06-283
245 mm

06-282 - 283
HEANEY modif.

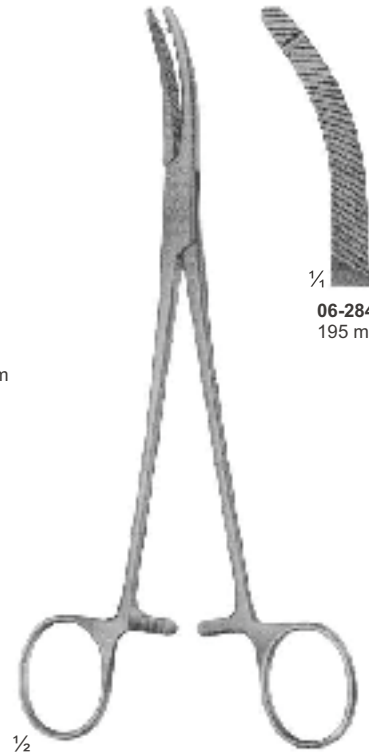

06-284
195 mm

06-284
HEANEY

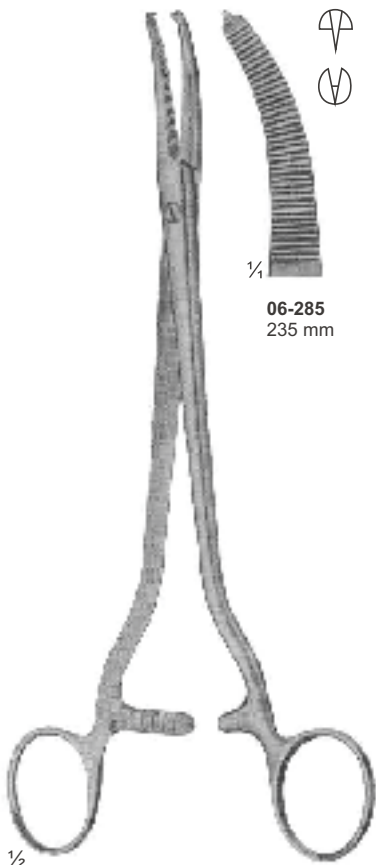

06-285
235 mm

06-285
WERTHEIM

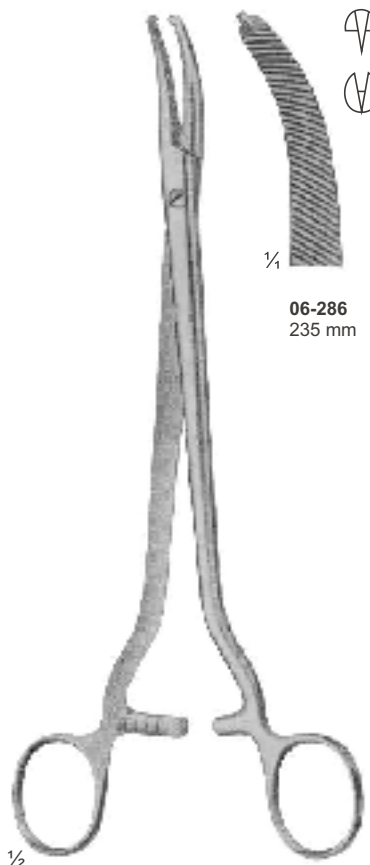

06-286
235 mm

06-286
WERTHEIM

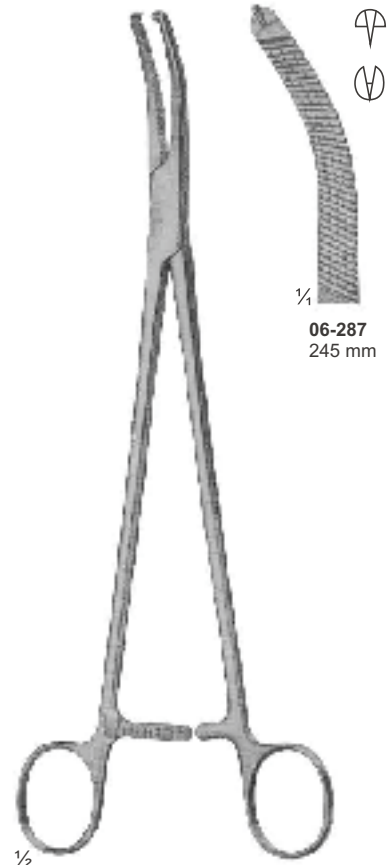

06-287
245 mm

06-287
WERTHEIM

Hysterectomy Forceps and Vaginal Clamps



06-288
225 mm



06-289
220 mm



06-290
215 mm

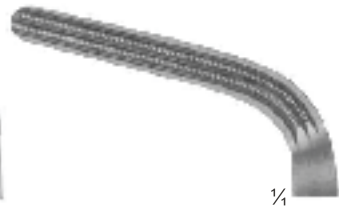

06-291
205 mm



06-292
250 mm



06-293
245 mm



06-294
240 mm

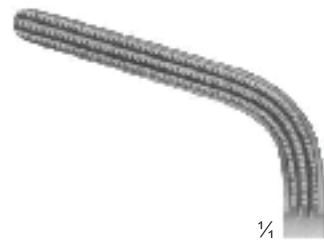

06-295
220 mm

Hysterectomy Forceps and Vaginal Clamps and Compression Forceps

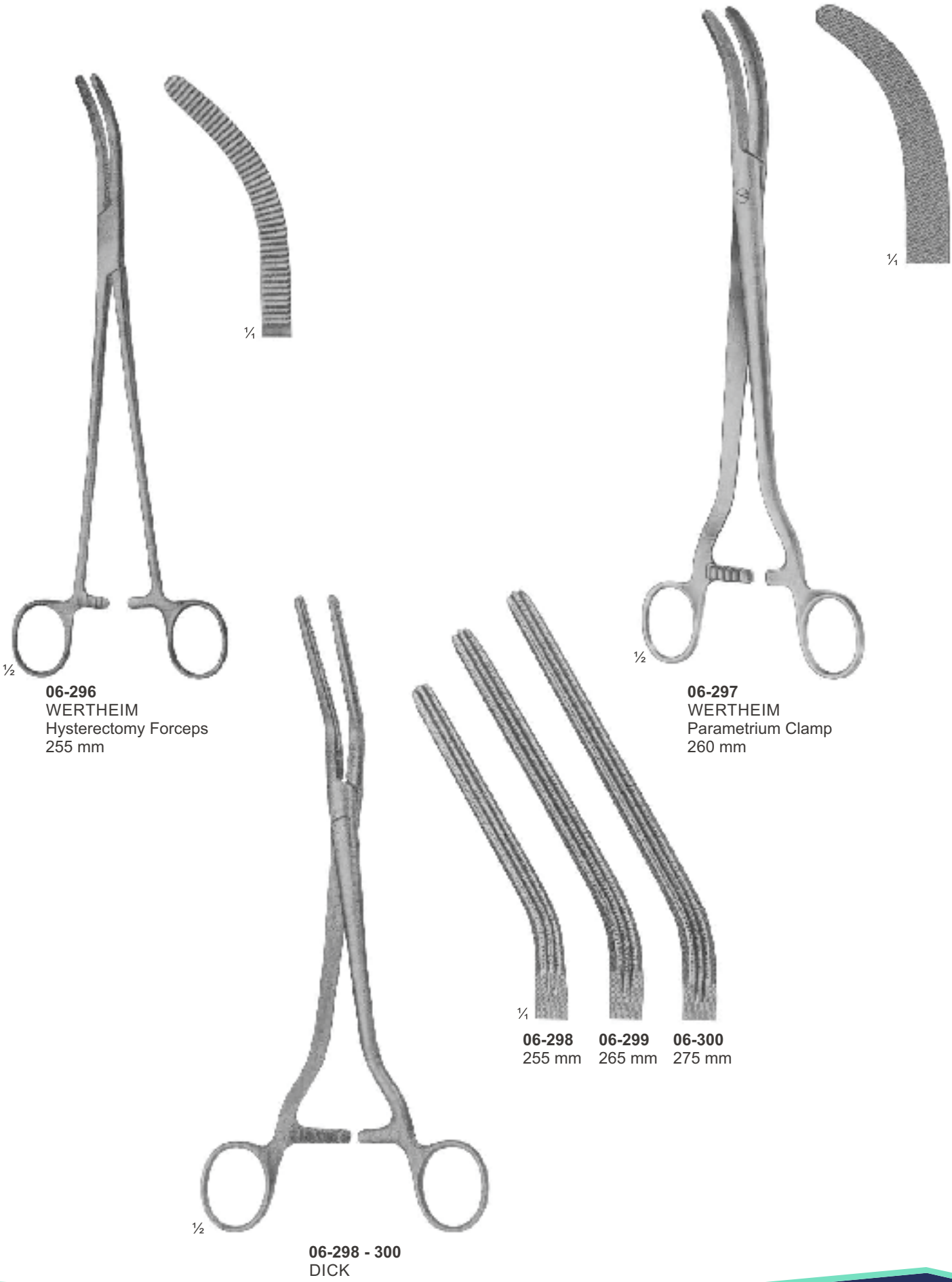

1/2
06-296
WERTHEIM
Hysterectomy Forceps
255 mm

1/2
06-297
WERTHEIM
Parametrium Clamp
260 mm

1/2
06-298 - 300
DICK

1/4
06-298 255 mm
06-299 265 mm
06-300 275 mm

Hysterectomy Forceps and Vaginal Clamps and Compression Forceps

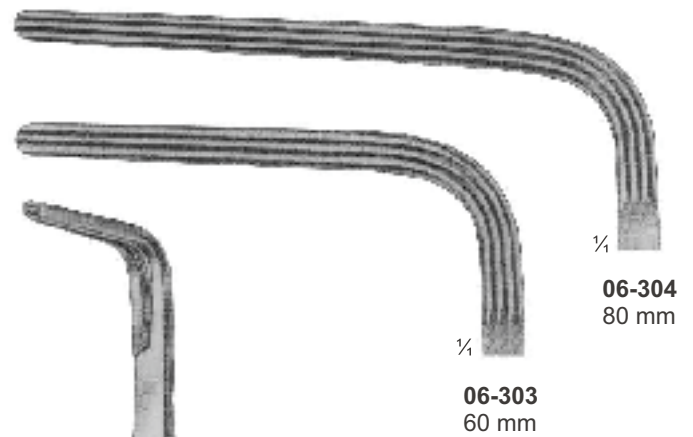
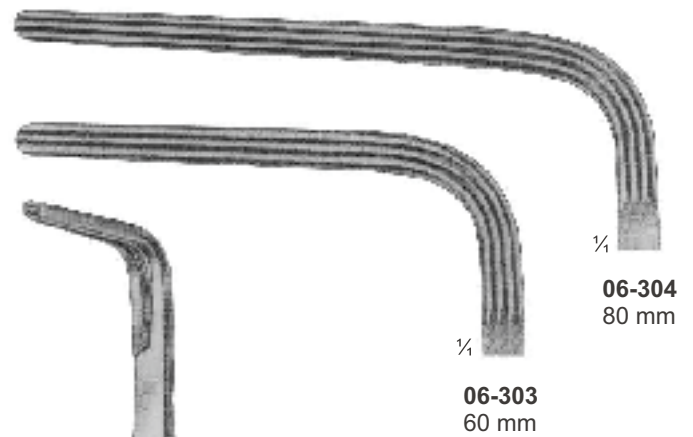
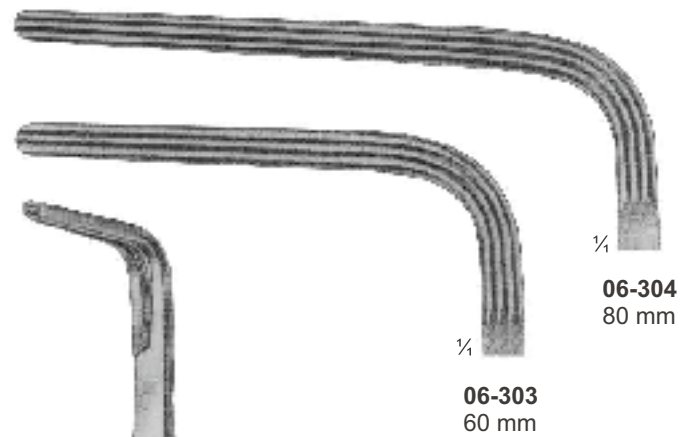
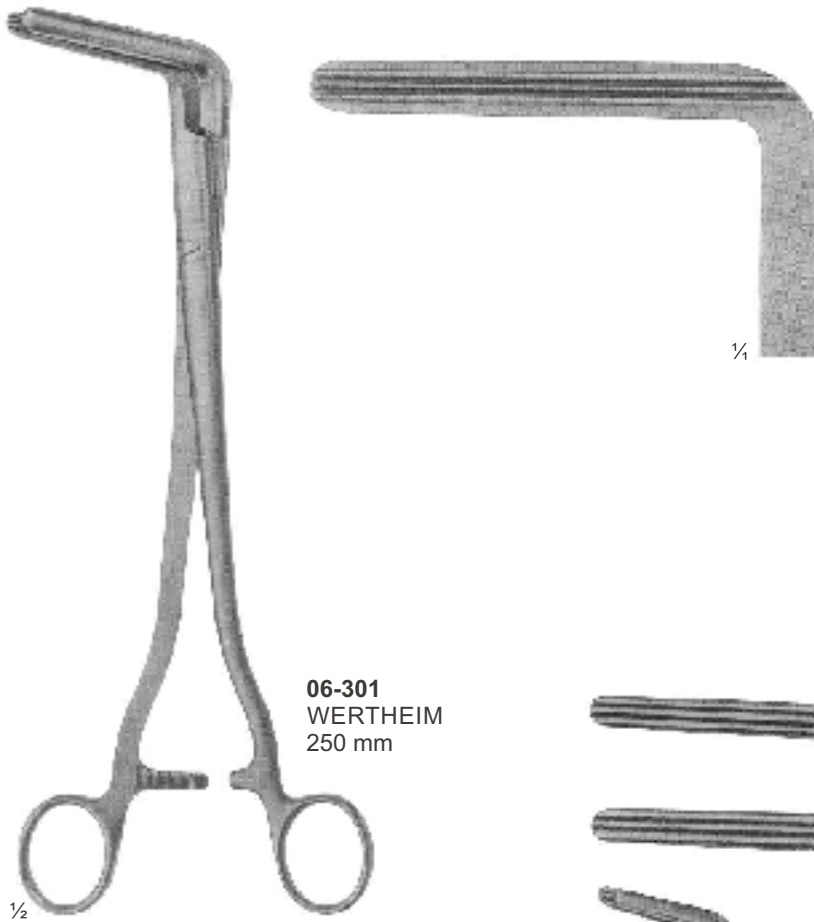

06-302
WERTHEIM-CULLEN



06-303 - 304
230 mm

Needle Holders For Micro Surgery

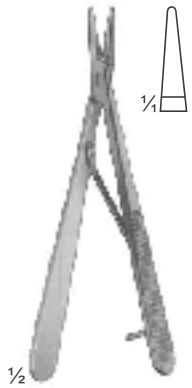

07-101
ROHRSCHEIDER
With copper inserts
100 mm



07-102
KALT
With catch
135 mm



07-103
ARRUGA
With catch
135 mm



07-104 - 105
CASTROVIEJO
With catch
145 mm



07-106 - 107
CASTROVIEJO
With Catch
160 mm



07-108 - 109
Without catch
185 mm



07-110 - 111
JACOBSON
185 mm



07-112
Without catch
195 mm



07-113 - 114
YASARGIL
With catch
200 mm

Micro Needle Holders With Round Handles

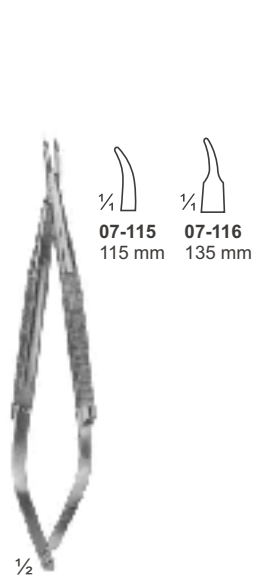

07-115 116
BARRAQUER
Without catch



07-117 - 118
BARRAQUER
Without catch
120 mm



07-119 - 120
BARRAQUER
With catch
120 mm



07-121 - 122
BARRAQUER
With Catch
150 mm



07-123
MULLER
With Locking
Mechanism
145 mm

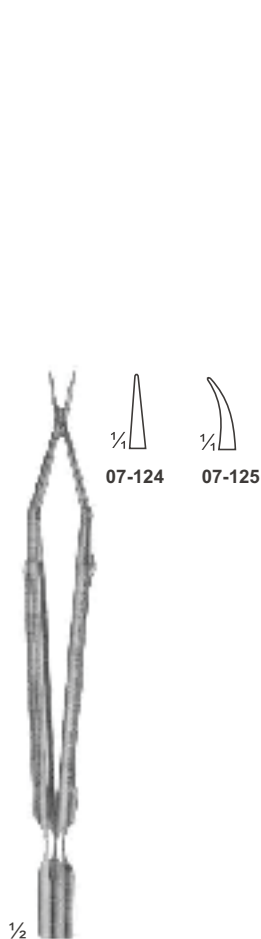

07-124 - 125
BROCK
Without catch
150 mm



07-126 - 127
YASARGIL
200 mm



07-128 - 129
YASARGIL
225 mm



07-130
YASARGIL
245 mm

Needle Holders

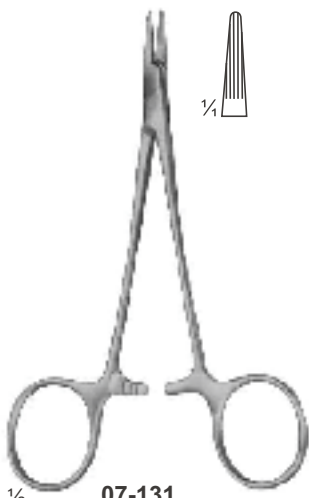

$\frac{1}{2}$ **07-131**
CONVERSE
125 mm

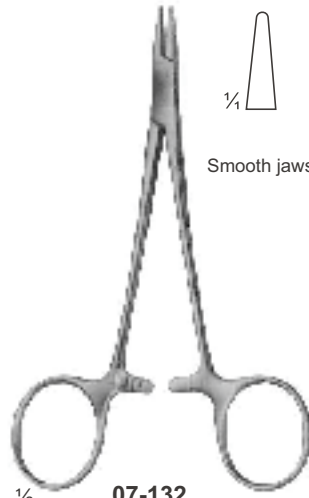
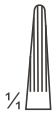

$\frac{1}{2}$ **07-132**
WEBSTER
125 mm

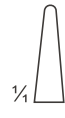

Smooth jaws

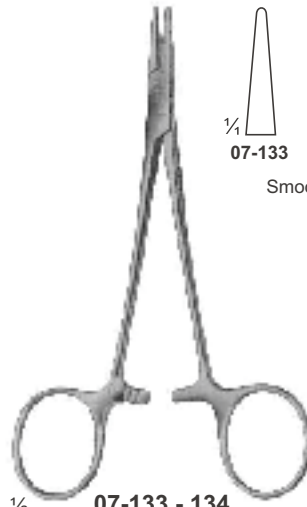

$\frac{1}{2}$ **07-133 - 134**
HALSEY
130 mm



07-133



07-134

Smooth jaws

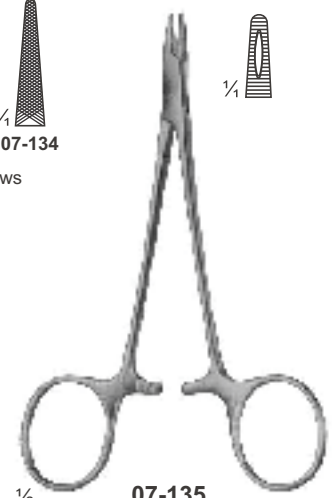

$\frac{1}{2}$ **07-135**
DERF
130 mm

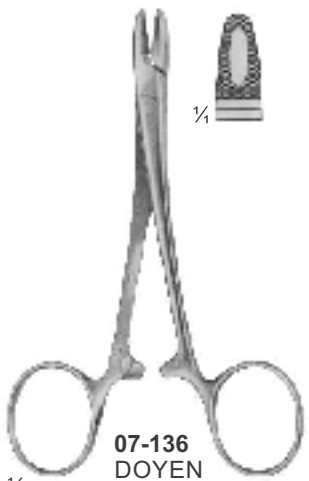
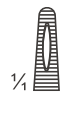

$\frac{1}{2}$ **07-136**
DOYEN
125 mm



$\frac{1}{2}$ **07-137**
BAUMGARTNER
145 mm



$\frac{1}{2}$ **07-138**
CRILE-WOOD
150 mm



Fine Pattern



$\frac{1}{2}$ **07-139**
CRILE-WOOD
160 mm

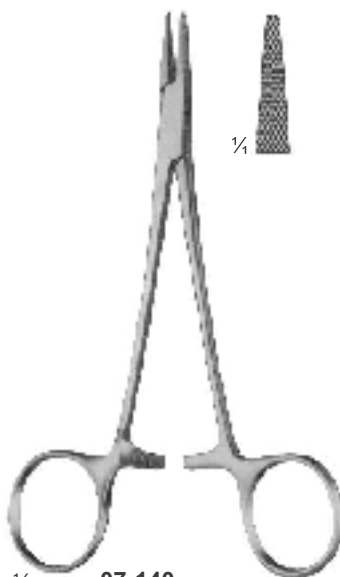

$\frac{1}{2}$ **07-140**
CRILE-MURRAY
150 mm



$\frac{1}{2}$ **07-141**
KILNER
135 mm



$\frac{1}{2}$ **07-142**
ADSON
175 mm

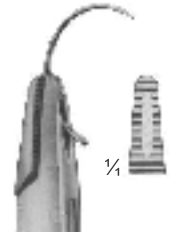

Needle Holders

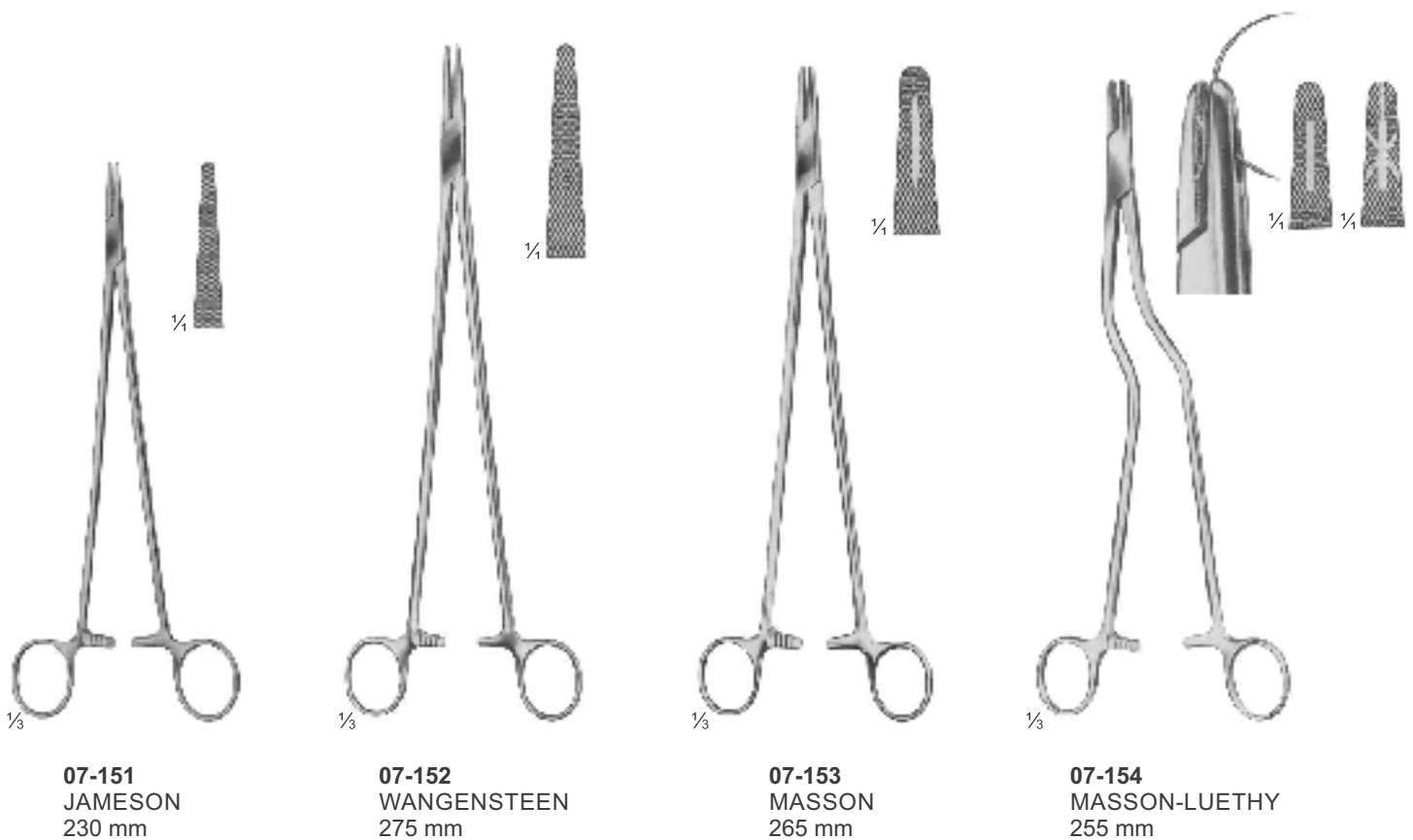
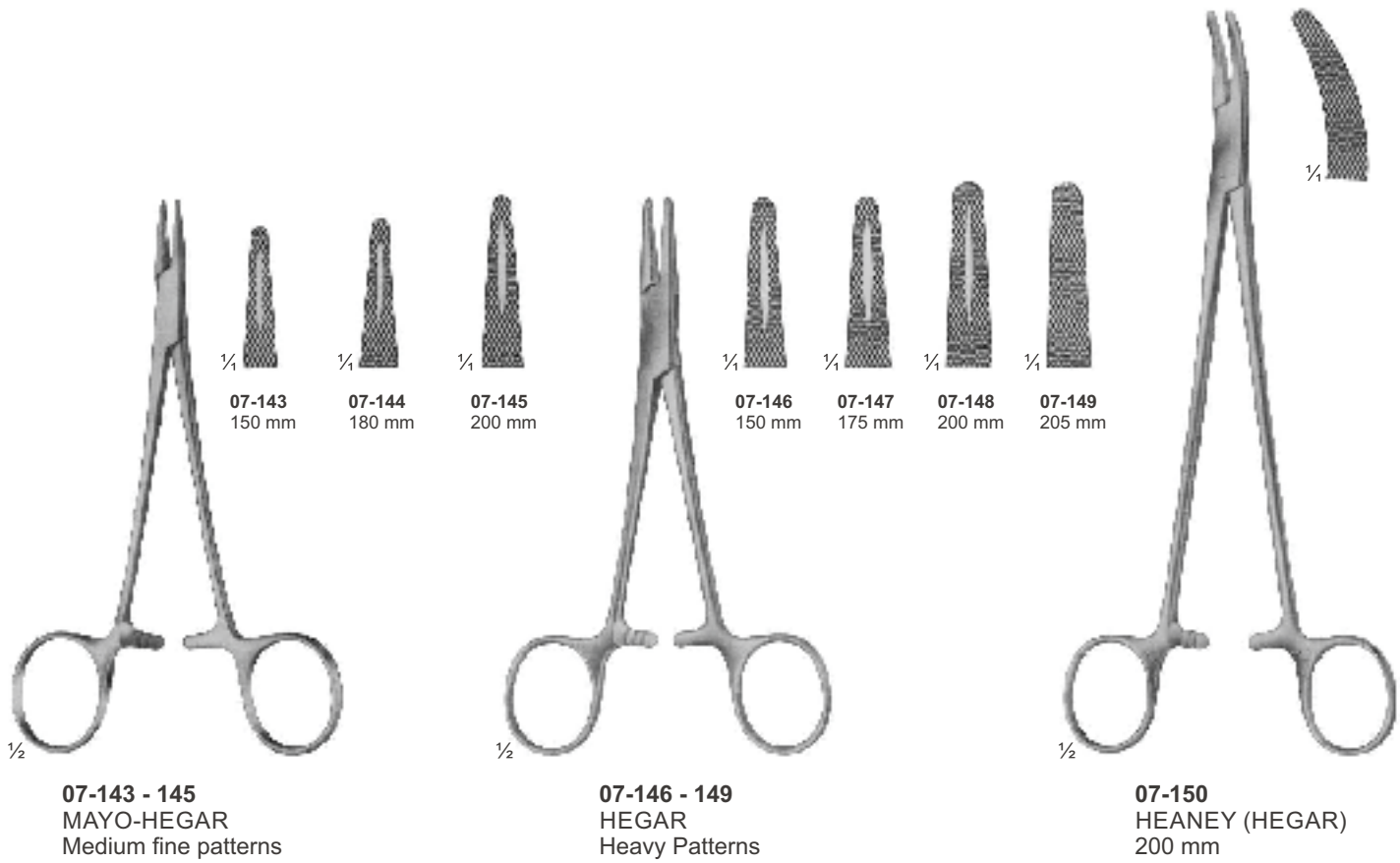

Needle Holders

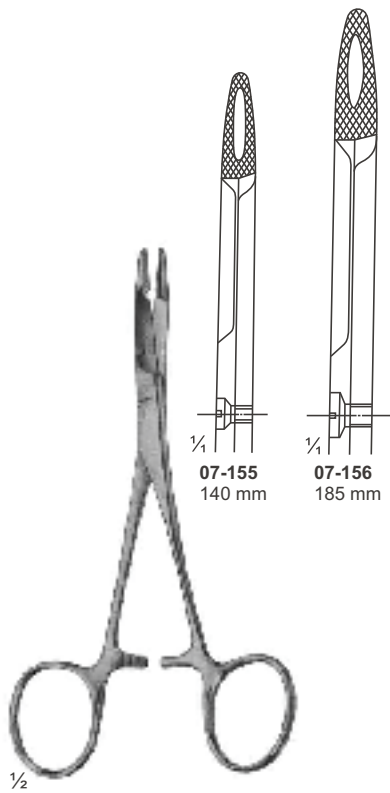

07-155 - 156
HEGAR-OLSEN
255 mm

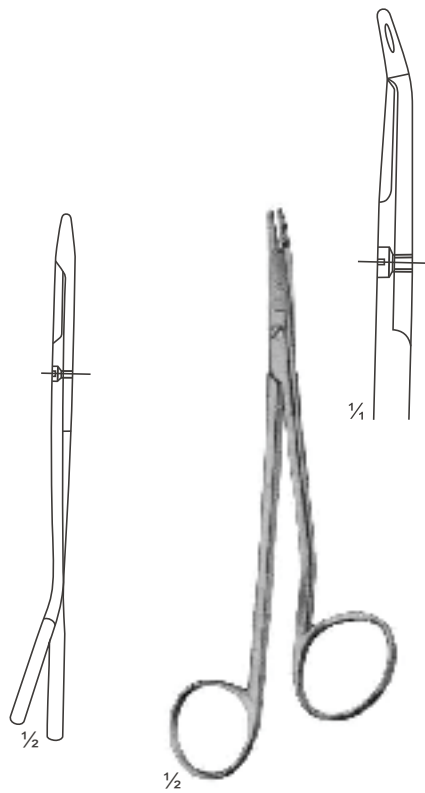

07-157
GILLIES
150 mm

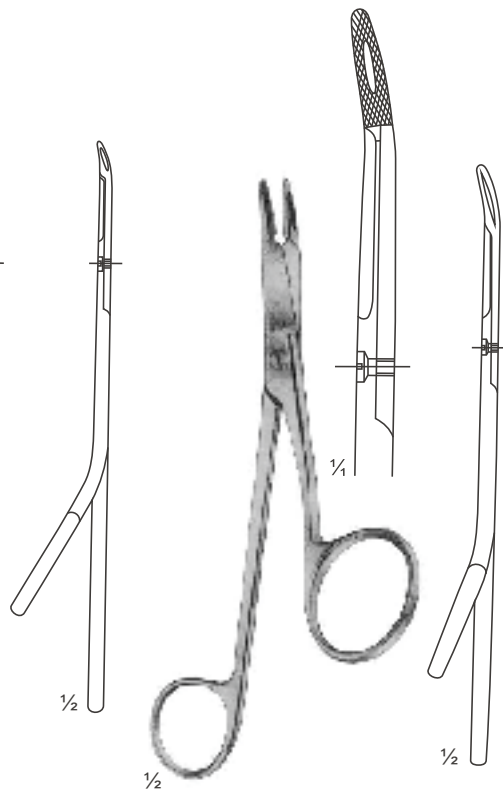

07-158
GILLIES
160 mm

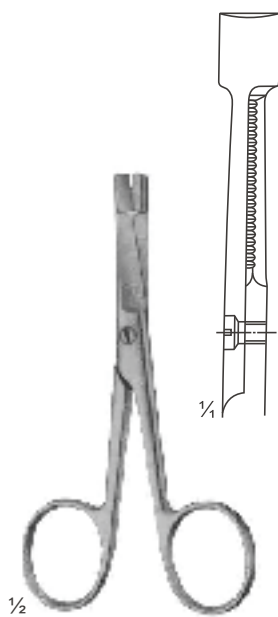

07-159
EISELSBERG
115 mm

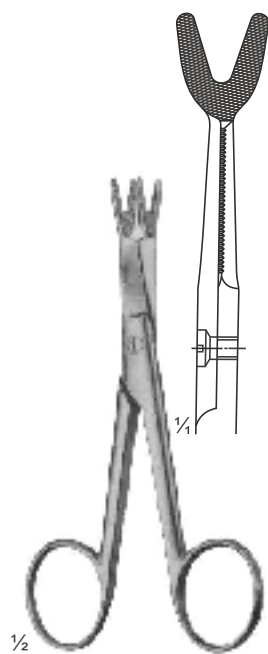

07-160
SCHOEMAKER-LOTH
125 mm



07-161
CRILE
150 mm



07-162
TONNIS
Elastic pattern for
dura-or intestinal suture

Needle Holders

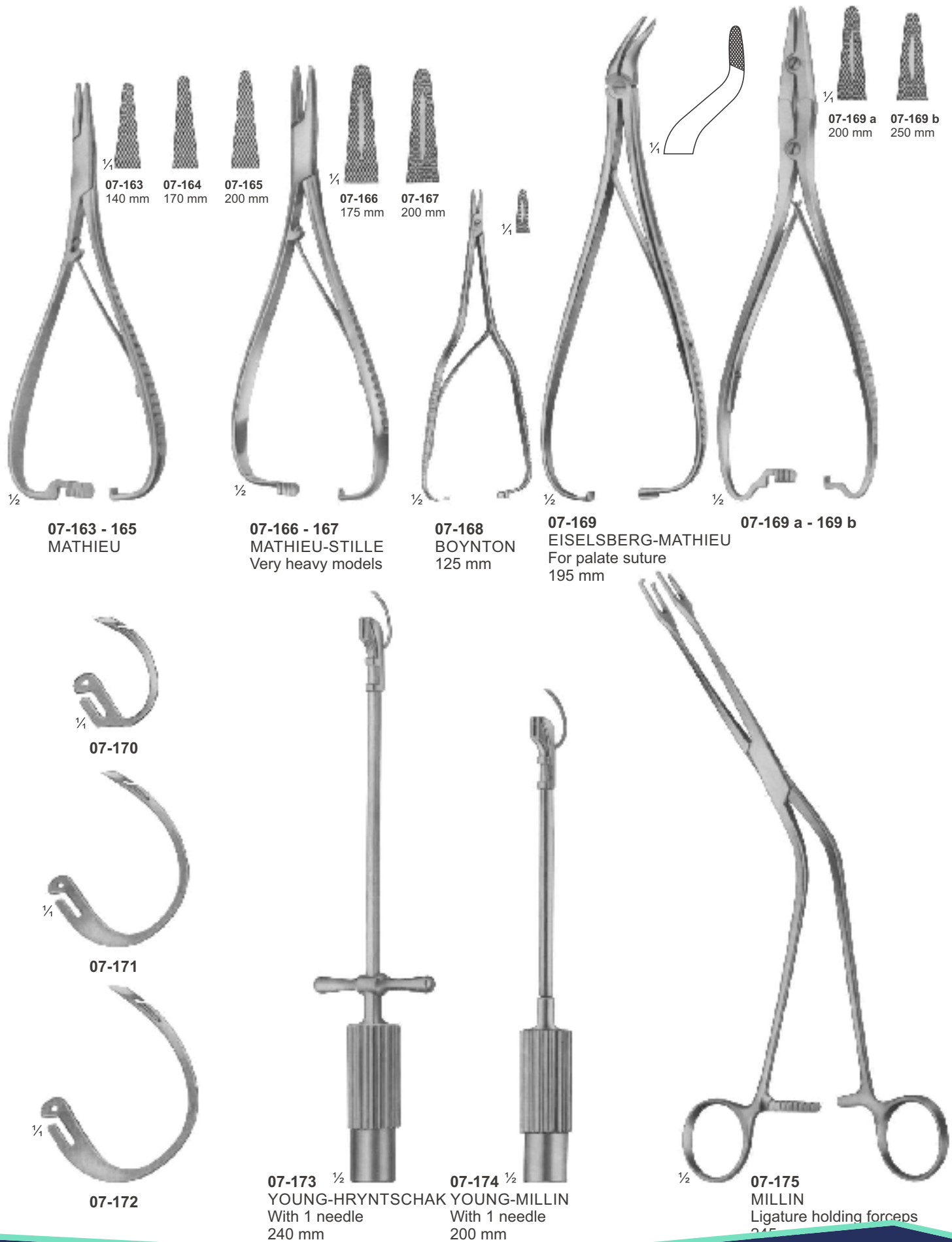

Suture Instruments - Reverdin Needles

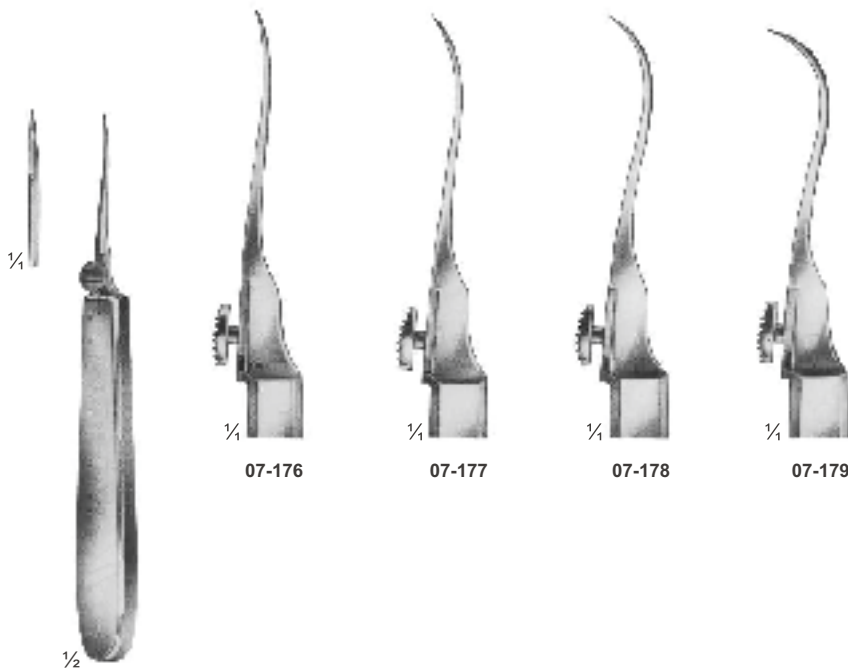

07-176 - 179
REVERDIN
140 mm



07-180 - 183
REVERDIN

07-184 - 188
REVERDIN
220 mm

Suture Instruments - Ligature Needles

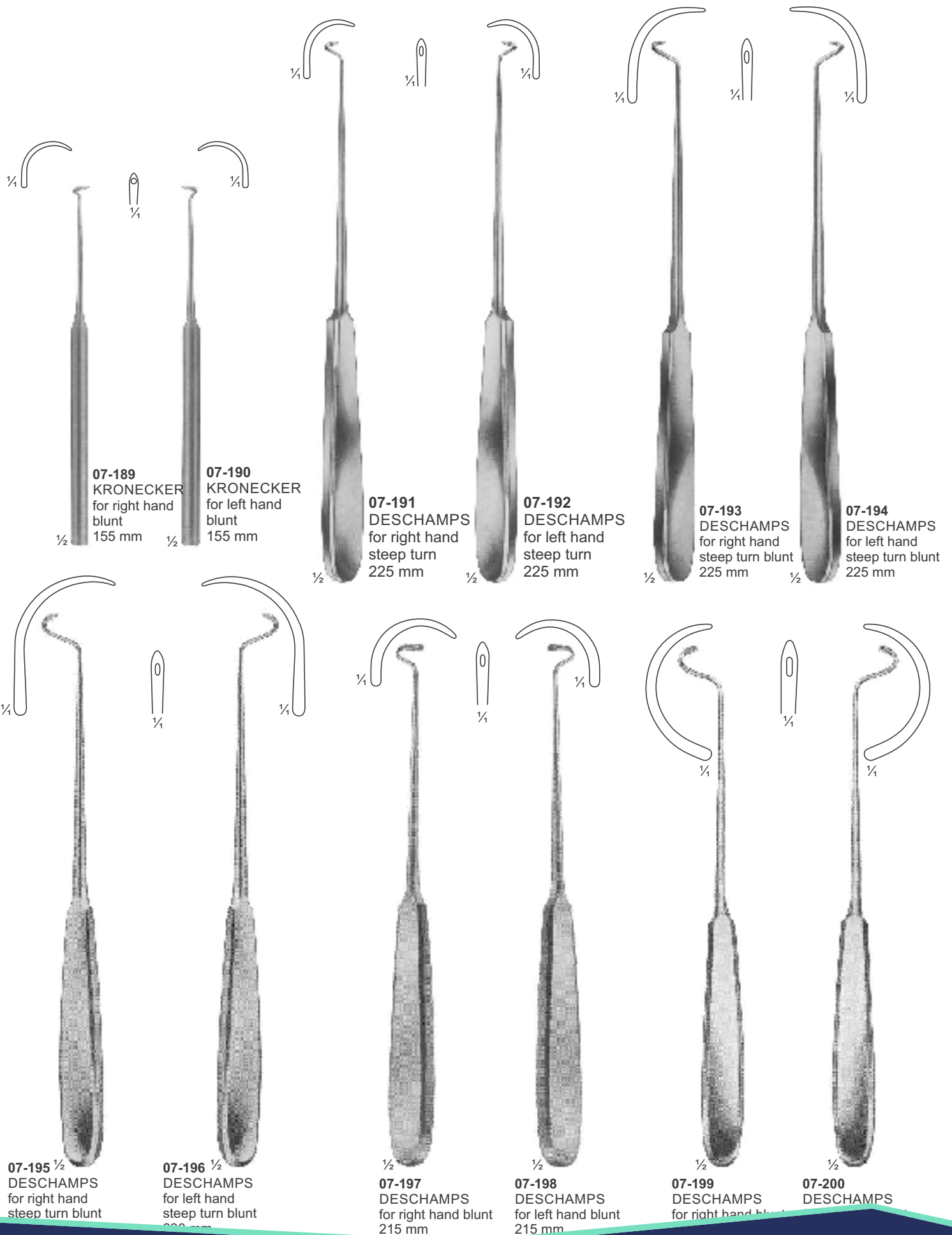

Suture Instruments - Ligature Needles



1/2
07-201
HURD
for right hand
sharp
210 mm



1/2
07-202
HURD
for left hand
sharp
210 mm



1/2
07-203
DESCHAMPS
for right hand
sharp
215 mm



1/2
07-204
DESCHAMPS
for left hand
sharp
215 mm



1/2
07-205
JONESCO
Needle for wire suture
185 mm



1/2
07-206
CLAUS VAN EICKEN
Needle for wire suture
250 mm

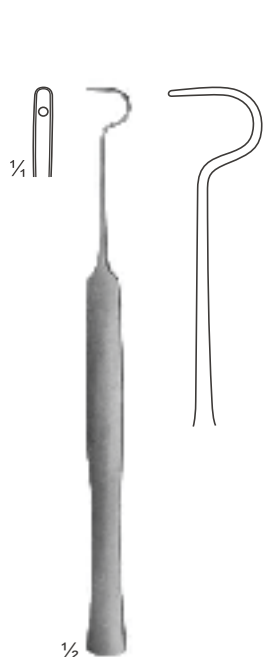

1/2
07-207
150 mm

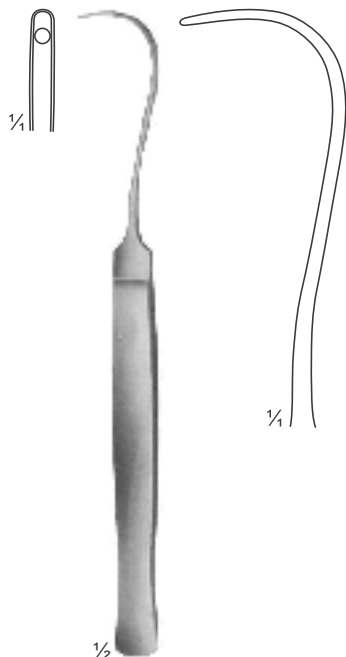

1/2
07-208
SYME
170 mm

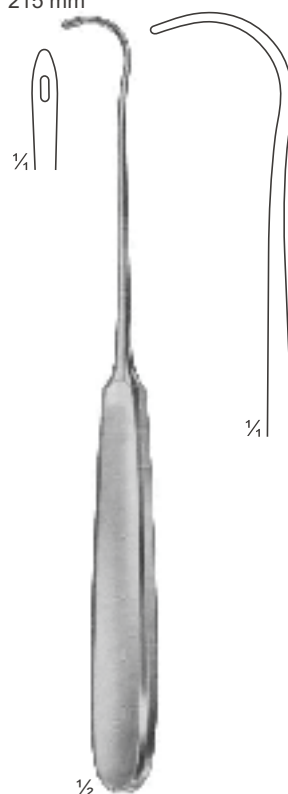

1/2
07-209
COOPER
205 mm

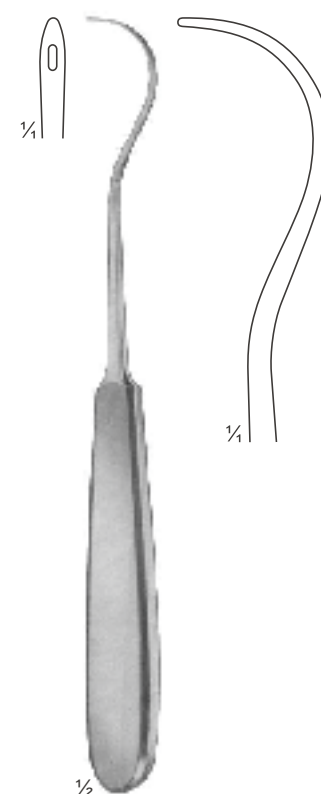

1/2
07-210
KOCHER

Ligature Needles

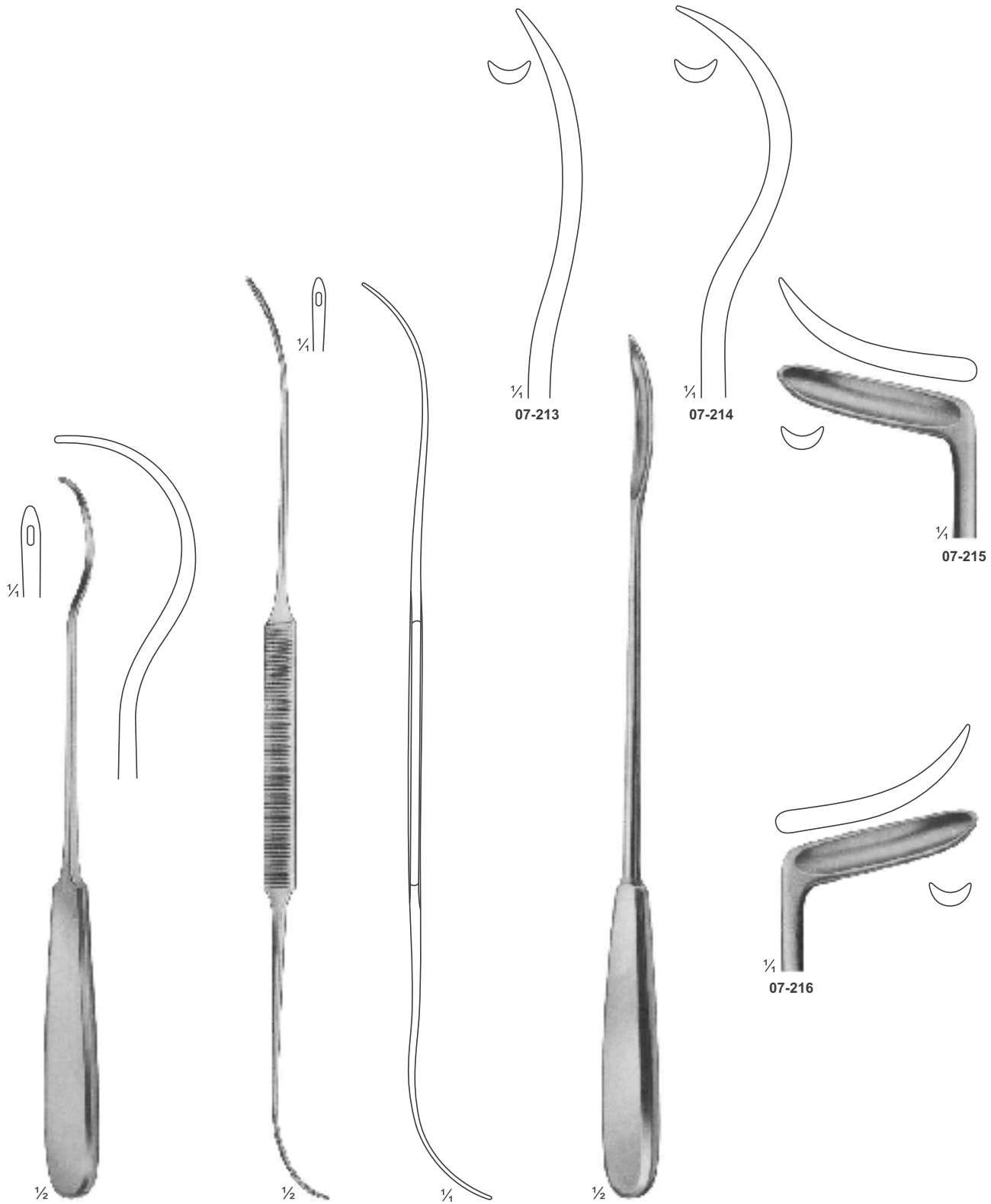

07-211
BRUNNER
240 mm

07-212
SCHMIEDEN-DICK
320 mm

07-213 - 216
BRUNNER
Guiding Probes
300 mm

Guiding Probes

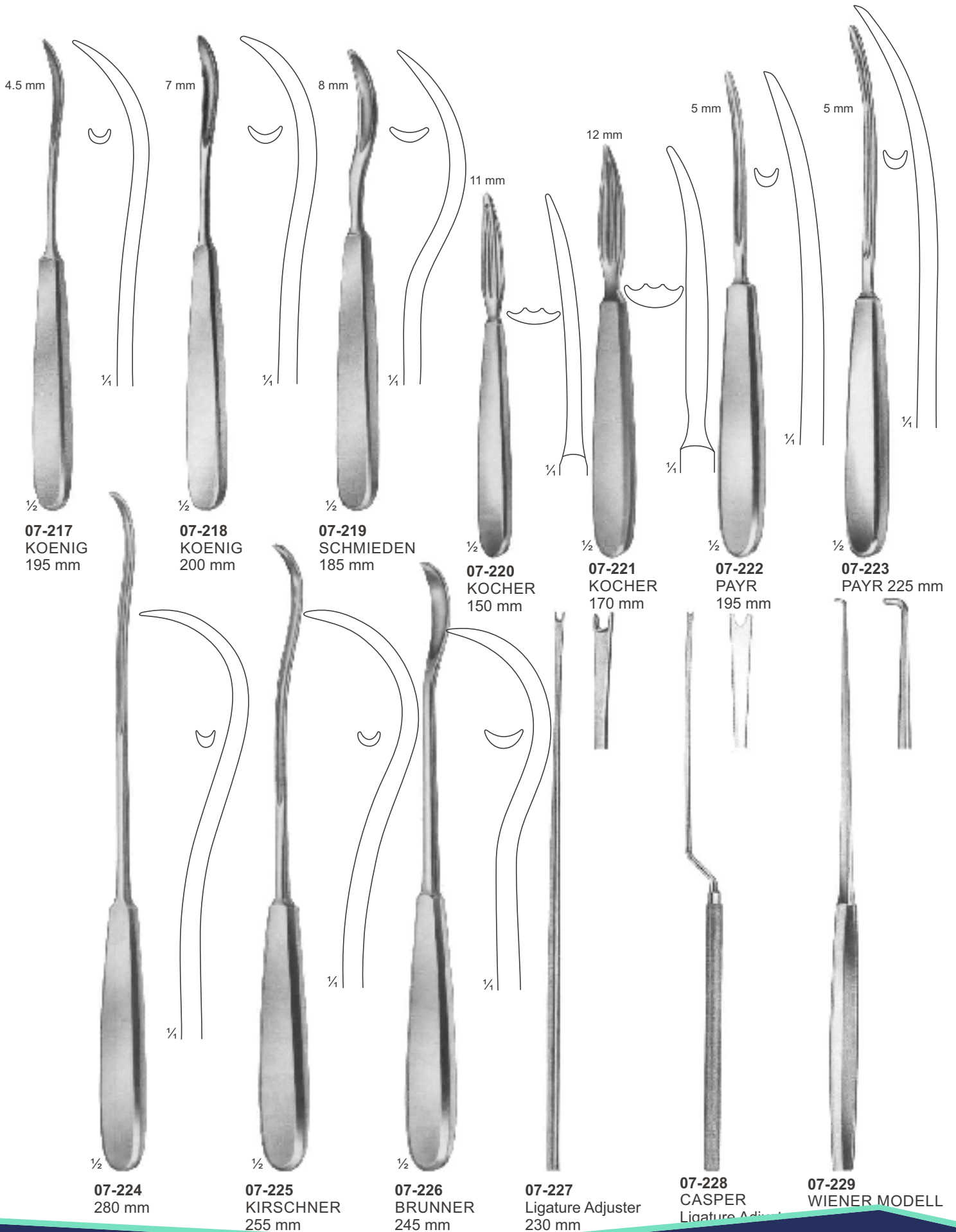

Probes

07-242
2,5 mm
07-243
2,5 mm
07-244
3,0 mm

1/2

07-242 145 mm
07-243 160 mm
07-244 200 mm
Probes with eye

1,5 mm

1/2

07-245
Myrtle leaf probe
145 mm

2,0 mm

1/2

07-246 130 mm
07-247 145 mm
07-248 160 mm
07-249 180 mm
07-250 200 mm

1/2

07-251
Probes

1/2

07-252
Double ended probe,
malleable, diam. of tips
3 mm with hole
190 mm

07-253
Double ended probes,
tin, malleable,
diam. of tips
3,5 mm with hole
250 mm, 300 mm

1/4

07-254
Double ended probes,
tin, malleable,
diam. of tips 4 mm
400 mm

1/3 ∅ tip

07-255 1,5 mm
07-256 2,0 mm
07-257 2,5 mm
300 mm

Probes



07-242 2,5 mm
07-243 2,5 mm
07-244 3,0 mm

07-242 145 mm
07-243 160 mm
07-244 200 mm
Probes with eye



07-245 1,5 mm
Myrtle leaf probe
145 mm



07-246 2,0 mm 130 mm
07-247 145 mm
07-248 160 mm
07-249 180 mm
07-250 200 mm



07-251 1/2
Probes



07-252 1/2
Double ended probe,
malleable, diam. of tips
3 mm with hole
190 mm



07-253
Double ended probes,
tin, malleable,
diam. of tips
3,5 mm with hole
250 mm, 300 mm



07-254 1/4
Double ended probes,
tin, malleable,
diam. of tips 4 mm
400 mm



07-255 1/3 Ø tip 1,5 mm
07-256 2,0 mm
07-257 2,5 mm
300 mm

Probes - Spatulas - Cotton Applicators



07-258
STACKE
100 mm



07-259
KILLIAN
165 mm



07-260
160 mm



07-261
SEIFFERT
180 mm



07-262
BOWMAN
130 mm

German Silver



07-263
SPATULA
145 mm



07-264
SPATULA
145 mm



07-265
Modell PICCOLO
Round Serrated
110 mm



07-266
Modell PICCOLO
Triangular Serrated end
110 mm



07-267
FARRELL
Round Serrated end
110 mm



07-268
LATHBURY-FARREL
Triangular Serrated end
110 mm



Cotton Applicators



07-269
BUCK
Rough, spiral end
120 mm

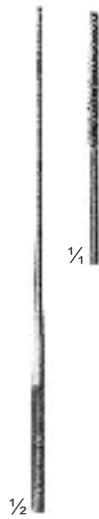

07-270
Triangular
serrated end
140 mm



07-271
Rough, spiral end
140 mm



07-272
Rough, spiral end
140 mm



07-273
Rough, spiral end
140 mm



07-274
FARRELL
Round,
serrated end
140 mm



07-275
LATHBURY-FARRELL
Triangular,
serrated end
140 mm

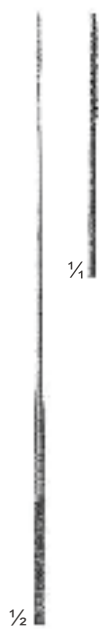

07-276
FARRELL
Rough,
spiral end
160 mm



07-277
LATHBURY-FARRELL
Triangular,
serrated end
160 mm



07-278
Triangular,
serrated end
160 mm



07-279
Rough,
spiral end
180 mm



07-280
Rough,
spiral end
180 mm



07-281
Rough,
spiral end
270 mm

Clip Applying Forceps - Suture Set



½
07-282
MICHEL
125 mm



½
07-283
HEGENBARTH
120 mm



½
07-284
WACHENFELDT
120 mm



½
07-285
WACHENFELDT
120 mm



½
07-286
MICHEL
125 mm



½
07-287
MICHEL modif.
130 mm



½
07-288
HEATH
135 mm



½
07-289
COLLIN
135 mm

Clip Applying Forceps - Suture Set



07-290

Suturing instruments set, in metal case consisting of: Scissors, curved, sharp/sharp, 115mm
25 MICHEL clip, 16 x 3mm
1 Delicate tissue forceps, 130mm
1 Scalpel, bellied
1 MATHIEU needle holder, 140mm
1 Perforated metal case, stainless containing:
1 Suture needle
1 item 1 item



07-291

Pocket instrument set, in metal case consisting of:

Bottom tray

1 MATHIEU needle holder, 140mm
1 MICHEL clip forceps, combined
1 Myrtle leaf probe, 130mm
1 Sharp double curette
1 Skin hook
1 Detachable scalpel handle, no.4
1 Perforated metal case, containing
6 Scalpel blades BB 520
1 Perforated metal case, stainless, containing
1 Suture needle
1 item
1 item

Top tray

1 Tissue forceps, 130mm
1 KOCHER haemostatic forceps, 130mm
1 Straight surgical scissors, 130mm
1 Dissecting forceps, 130mm
1 FEILCHENFELD splinter forceps, 115mm
25 MICHEL clip, 16 x 3mm
1 Flacon of suture skin, sterile in alcohol

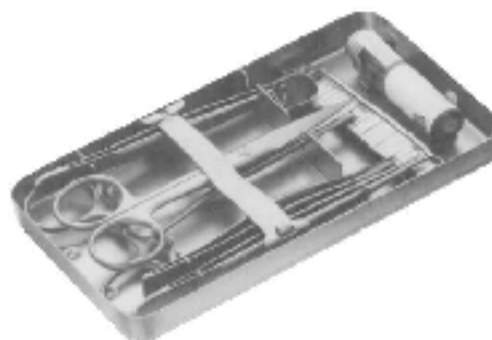

07-292

Pocket instrument set, in metal case consisting of:

Bottom tray

1 MAYO-HEGER needle holder, 150mm
1 MICHEL clip forceps, combined
1 Myrtle leaf probe, 130mm
1 Sharp double curette
1 Skin hook
1 Detachable scalpel handle, no. 4
1 Perforated metal case, consisting
6 Scalpel blades BB 520
1 Perforated metal case, stainless, consisting:
1 Suture needle

Bottom tray

1 Tissue forceps, 130mm
1 CRILE haemostatic forceps, 140mm
1 Straight surgical scissors, 130mm
1 Dissecting forceps, 130mm
1 FEILCHENFELD splinter forceps, 115mm
25 MICHEL clip, 16 x 3mm
1 Flacon of suture silk, sterile in alcohol

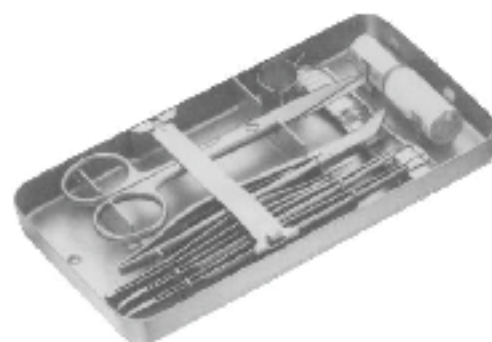

Clip Applying Forceps - Suture Set

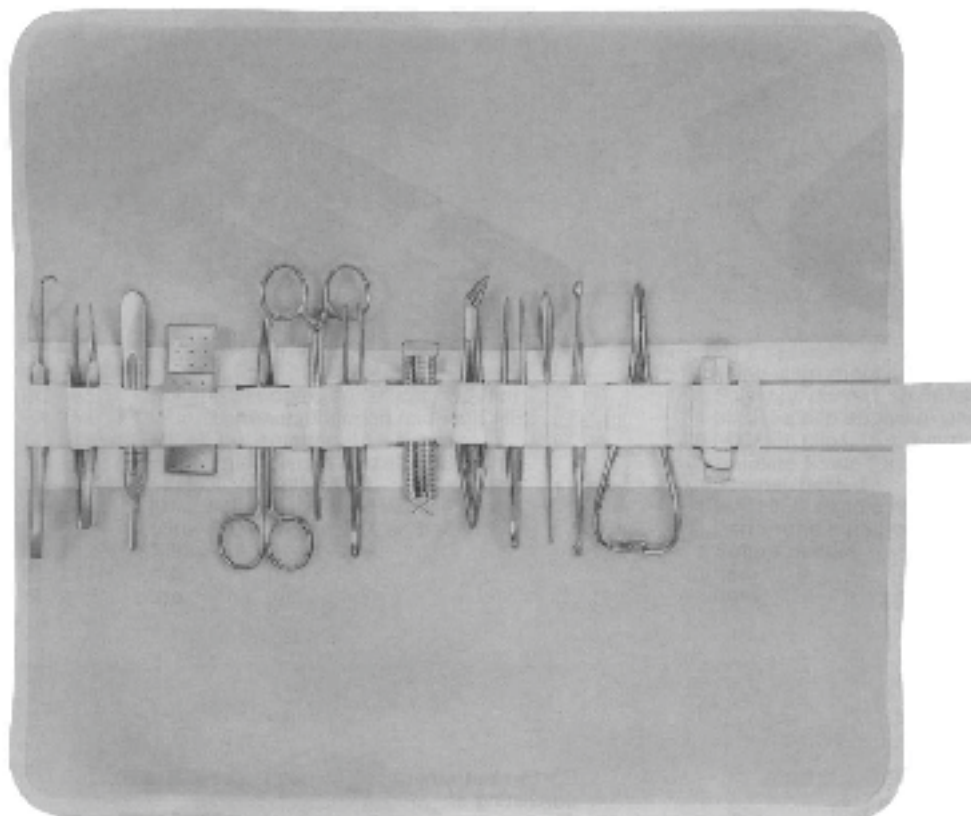

07-293

Pocket instrument set in metal case 170 x 90mm with sterilizable canvas roll consisting of:

- 1 Myrtle leaf probe, 130mm
- 1 Sharp double curette
- 1 FEILCHENFELD splinter forceps, 115mm
- 1 Dissecting forceps, 130mm
- 1 Tissue forceps, 130mm

- 1 Straight surgical scissors, 130mm
- 1 Scalpel handle no. 4
- 1 Perforated metal case, consisting of 6 scalpel blades BB 520
- 1 KOCHER haemostatic forceps, 130mm
- 1 Skin hook
- 1 MATHIEU needle holder, 140mm
- 1 Tube of suture skin, sterile in alcohol
- 1 MICHEL clip forceps, 120mm

- 25 MICHEL clip, 16 x 3mm
- 1 Perforated metal case, stainless, consisting of:
- 1 Suture needle
- 1 item
- 1 item

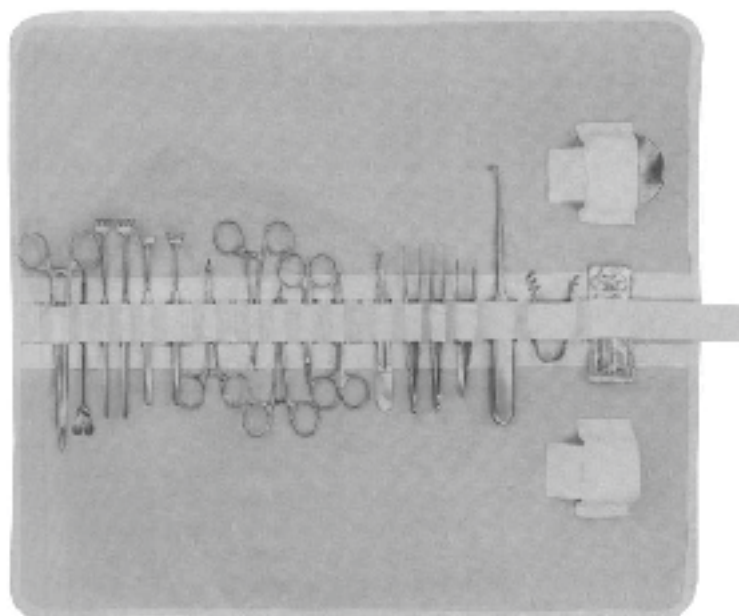

07-294

Venae sectio set, in sterilizable canvas roll consisting of:

- 1 Tissue forceps, 1 x 2 teeth, 140mm
- 1 Dissecting forceps, 145mm
- 1 FEILCHENFELD straight scissors, sharp, 110mm
- 1 curved scissors, blunt, 115mm
- 1 HALSTED mosquito forceps, curved on flat,

- 1 DESCHAMPS needle, blunt, 210mm
- 1 DOYEN Director, curved, 140mm
- 2 Wound retractors, 4 blunt prongs, 160mm
- 2 DESMARRS wound retractors, 135mm
- 1 FINSSEN retractors, 2 x3 blunt prongs, 80mm

- 1 Scalpel handle no. 4
- 4 Sterile scalpel blades, no 18, single peel pack
- 1 Needle box, perforated, round, diam. 65mm
- 1 HEGAR-MAYO DUROGRIP needle holder, 180mm

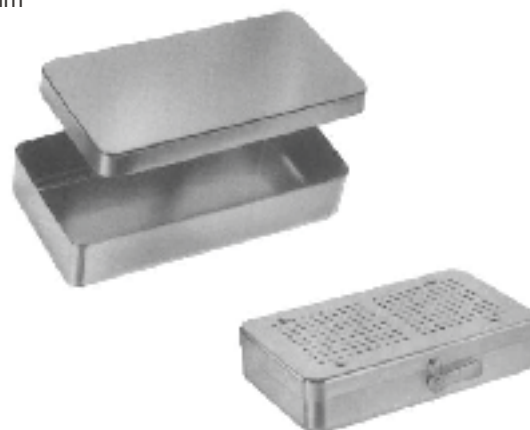

Clip Applying Forceps - Suture Set

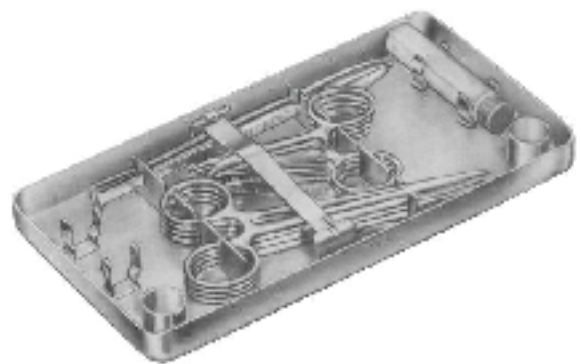

07-295

Venae sectio set, in metal case
consisting of:

Bottom tray

- 1 MATHIEU needle holder, fine pattern 140mm
- 1 Ligature needle, fine short pattern
- 1 DOYEN director, curved
- 1 HEGENBARTH clip forceps,
- 1 ELSCHNIG tissue forceps, 1 x 2 teeth fine, 150mm
- 1 Dressing forceps, fine 105mm
- 1 Tissue forceps, 1 x 2 teeth, 110mm
- 1 Vessel scissors, straight, with 1 ball point, 110mm
- 1 Vessel scissors, curved, pointed 105mm
- 1 FINSEN retractor
- 1 Perforated needle case

Top tray

- 1 Scalpel, pointed
- 1 Scalpel, bellied
- 2 HALSTED mosquito forceps, curved, 125mm
- 2 HALSTED mosquito forceps, straight, 1x 2 teeth, 125mm
- 3 BACKHAUS towel forceps, 90mm
- 2 Flacon holder

Nerve - and Vessel Hooks

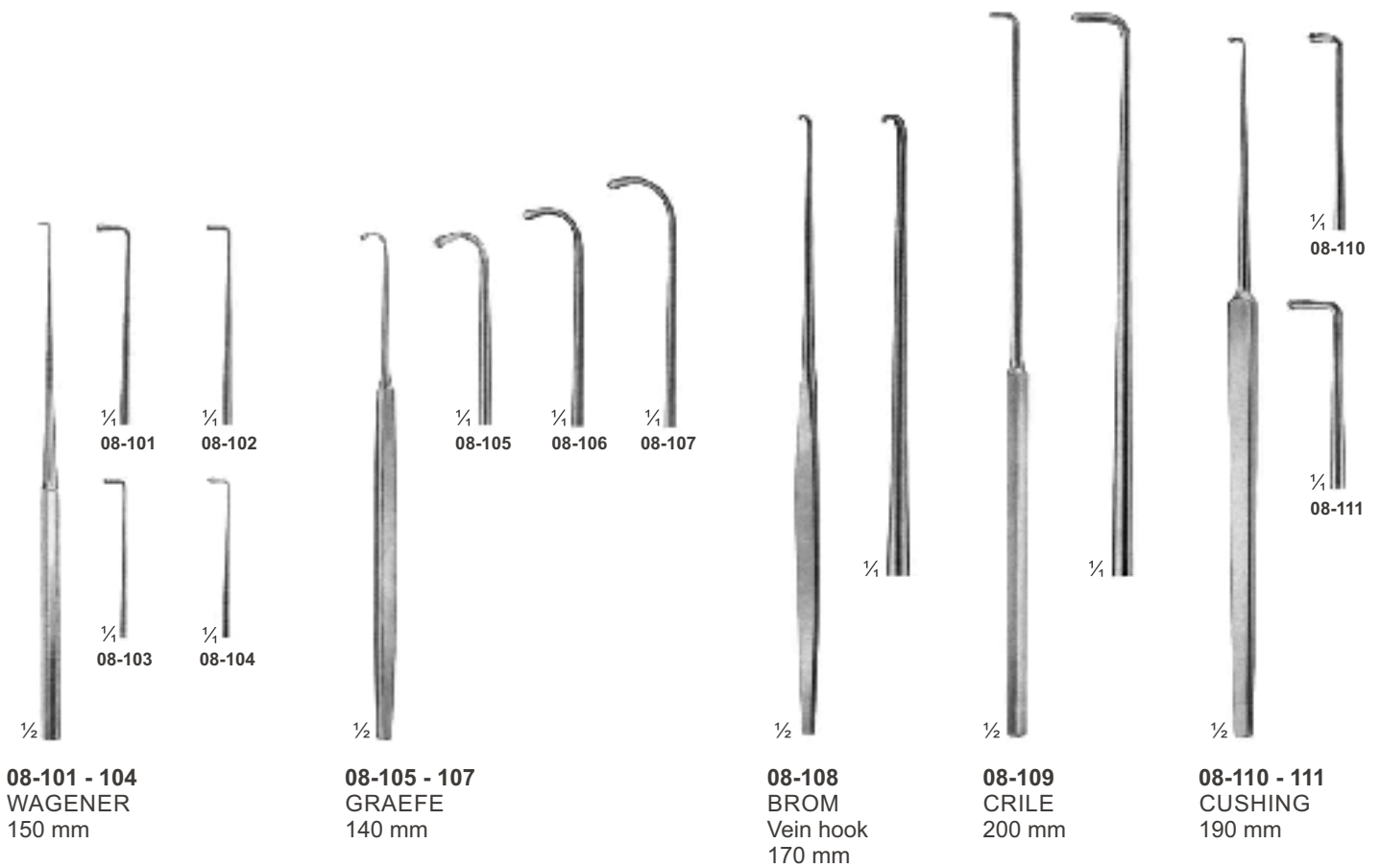

Nerve - and Vessel Hooks

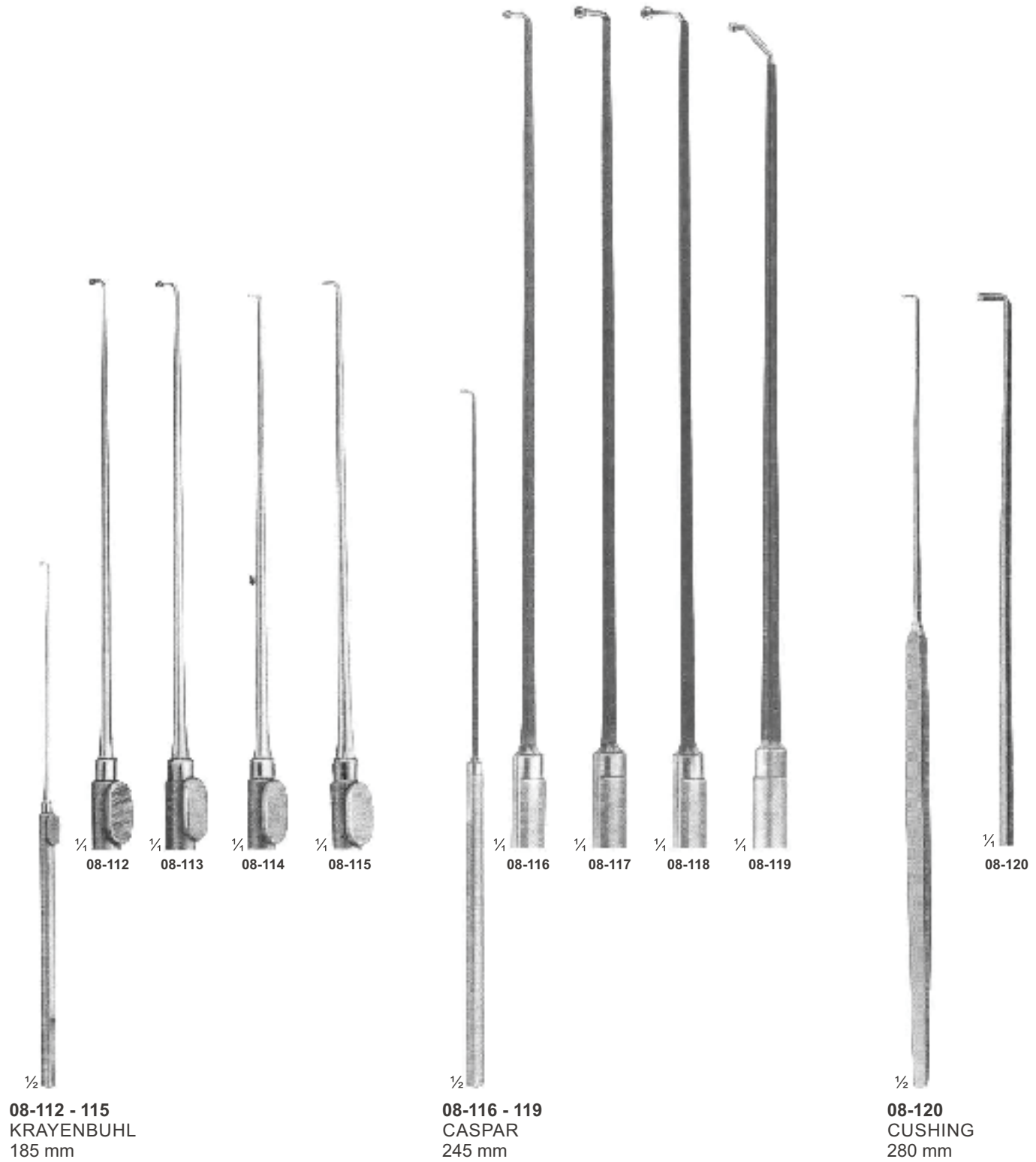

08-112 - 115
KRAYENBUHL
185 mm

08-116 - 119
CASPAR
245 mm

08-120
CUSHING
280 mm



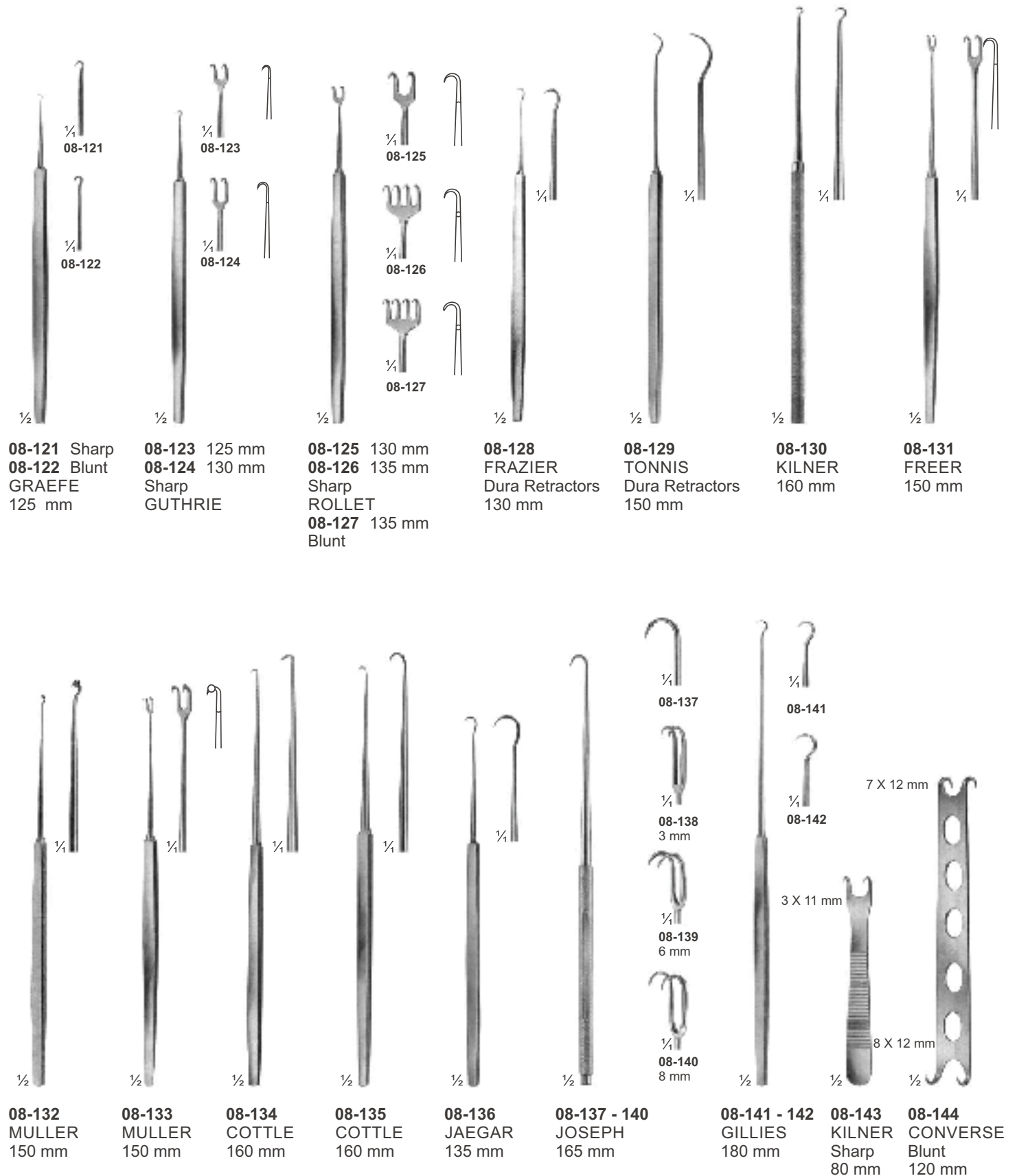

Fine Wound Retractors (Dura- and Skin Retractors)

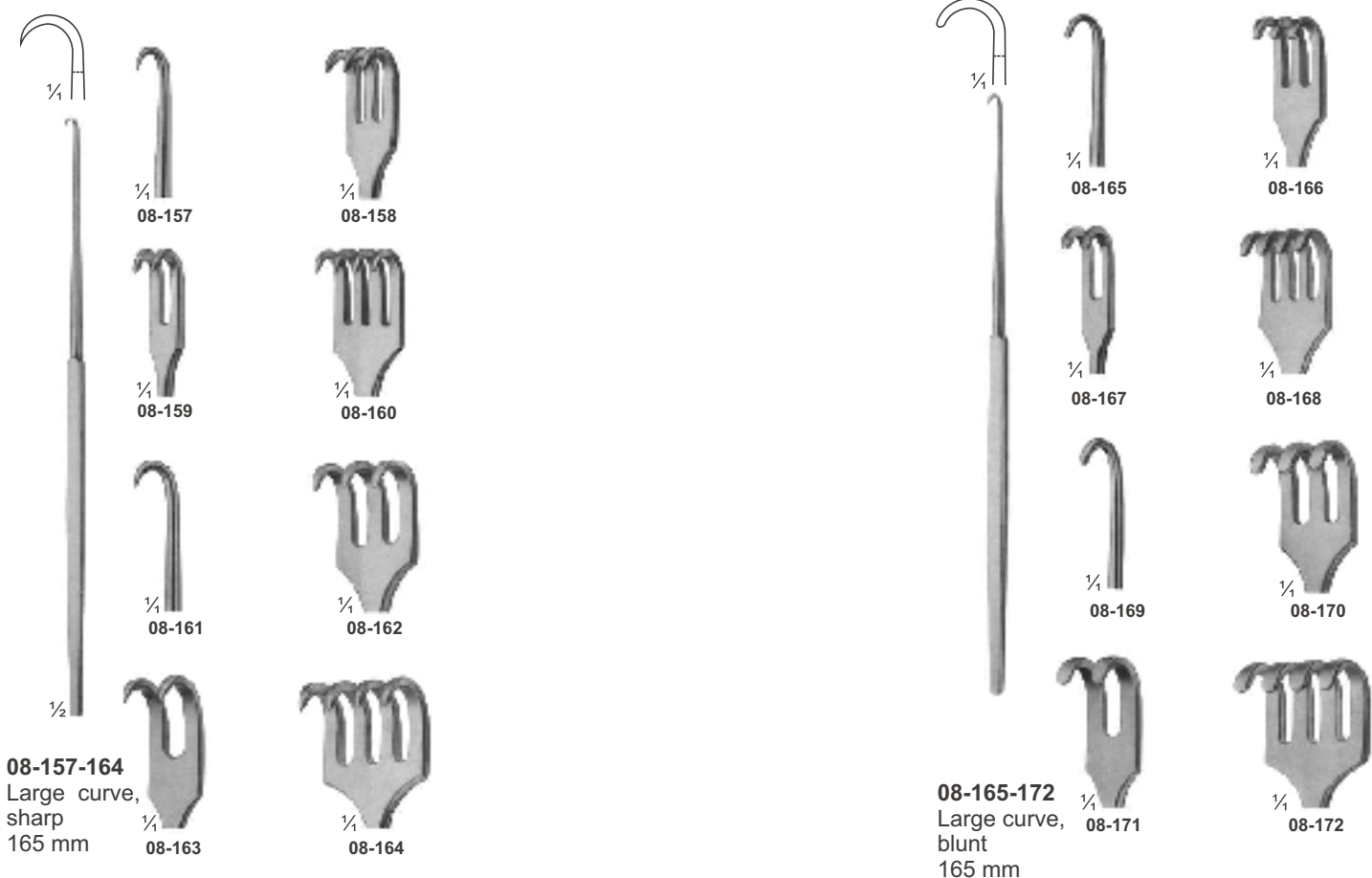

Wound - Trachea Retractors

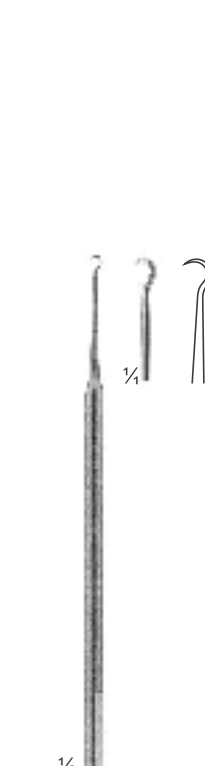
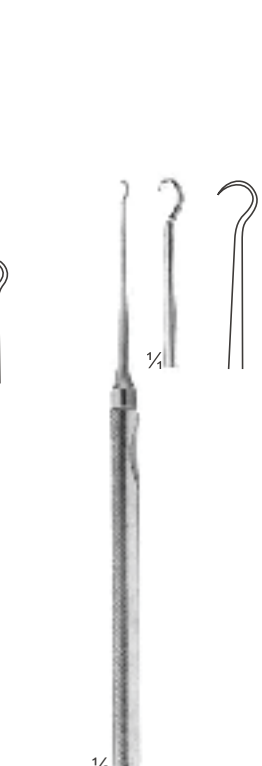
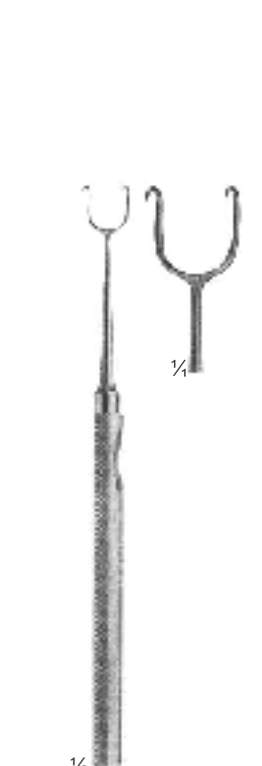
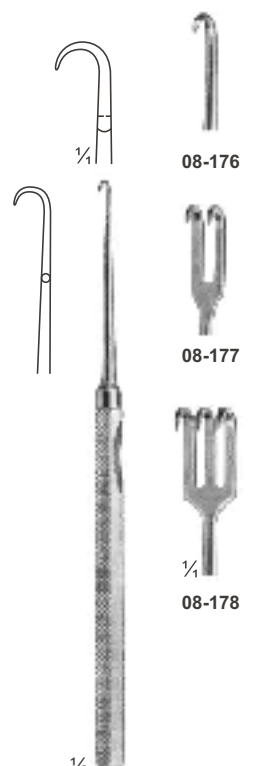

Retractors With Treangle Handle

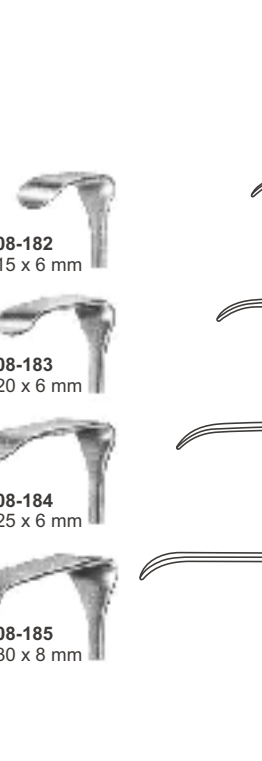
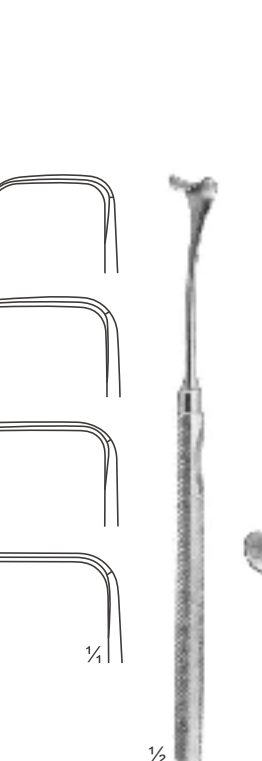
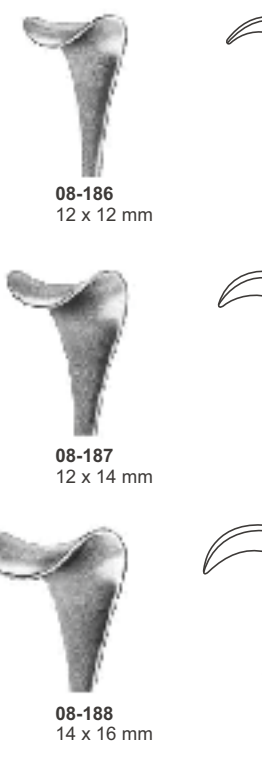
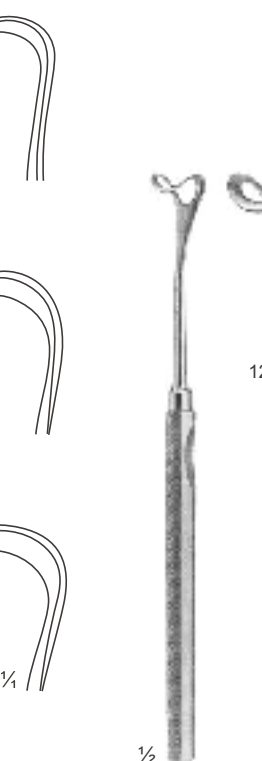
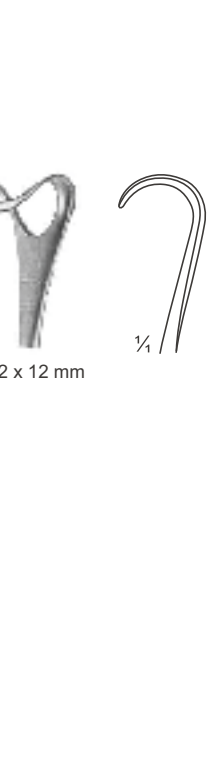
| | | | | | |
|---|---|--|---|--|--|
|  <p>1/2</p> |  <p>1/2</p> |  <p>1/2</p> |  <p>1/2</p> |  <p>1/2</p> |  <p>1/2</p> |
| <p>08-173 MANNERFELT modif. sharp 135 mm</p> | <p>08-174 MANNERFELT modif. sharp 155 mm</p> | <p>08-175 MANNERFELT modif. sharp 155 mm</p> | <p>08-176 - 178 MANNERFELT modif. Small curve, sharp 155 mm</p> | <p>08-179 - 181 MANNERFELT modif. Large curve, blunt 155 mm</p> | |
|  <p>1/2</p> |  <p>1/2</p> |  <p>1/2</p> |  <p>1/2</p> |  <p>1/2</p> |  <p>1/2</p> |
| <p>08-182 - 185 LANGENBECK- MANNERFELT modif. 155 mm</p> | <p>08-182 15 x 6 mm</p> <p>08-183 20 x 6 mm</p> <p>08-184 25 x 6 mm</p> <p>08-185 30 x 8 mm</p> | <p>08-186 - 188 MANNERFELT modif. Saddle hooks, 155 mm</p> | <p>08-186 12 x 12 mm</p> <p>08-187 12 x 14 mm</p> <p>08-188 14 x 16 mm</p> | <p>08-189 MANNERFELT modif. Saddle hooks, fenestrated 155 mm</p> | <p>12 x 12 mm</p> |

Retractors

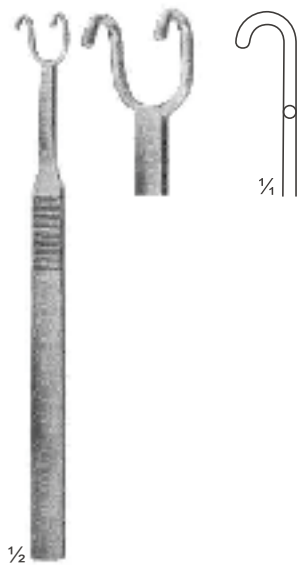

08-190
FOMON
145 mm



08-191 - 192
160 mm

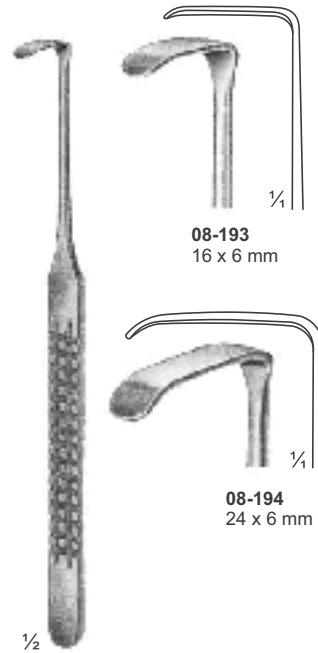

08-193 - 194
LANGENBECK-GREEN
160 mm

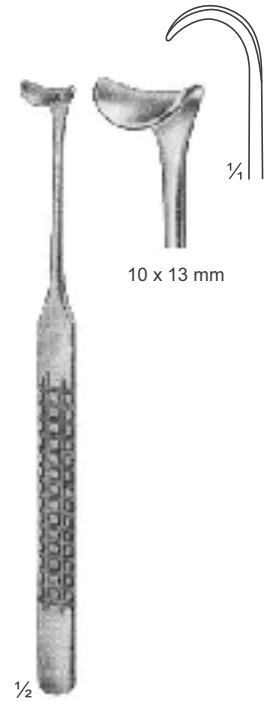

08-195
160 mm

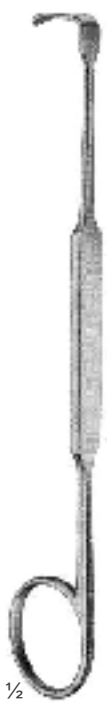

08-196 - 201
MEYERDING
Fig. A - Fig. F
180 mm

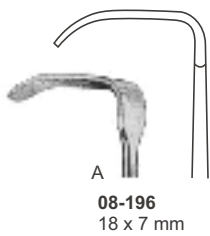

08-196
18 x 7 mm

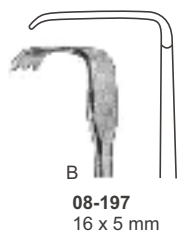

08-197
16 x 5 mm

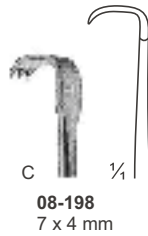

08-198
7 x 4 mm

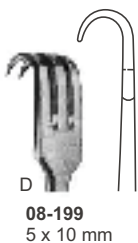

08-199
5 x 10 mm



08-200
11 x 4 mm

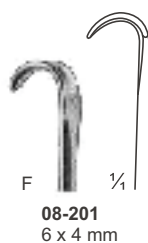

08-201
6 x 4 mm

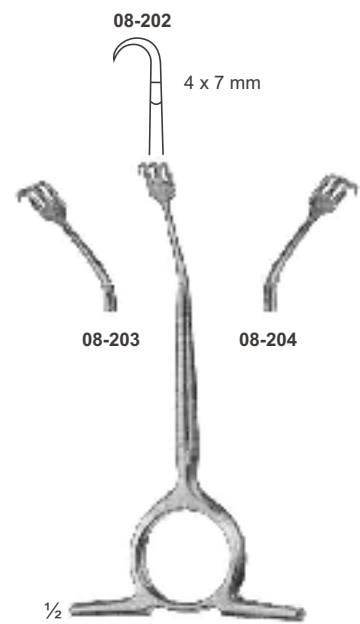

08-202
4 x 7 mm

08-203

08-204

08-202 - 204
WILLIGER
120 mm

Retractors



08-205
EMMETT
Fistula hook
220 mm



08-206
SIMON
Fistula hook
220 mm

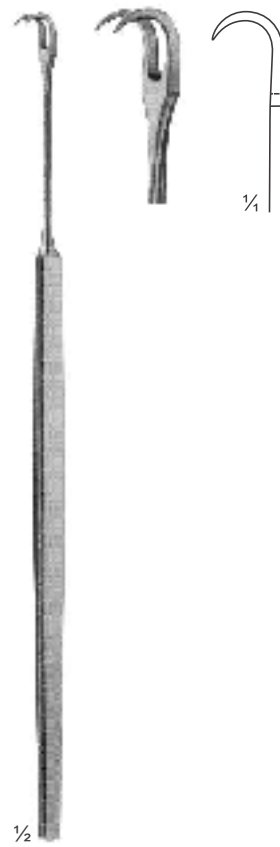

08-207
SIMON
Fistula hook
220 mm



08-208
LANGE
Fistula hook
230 mm

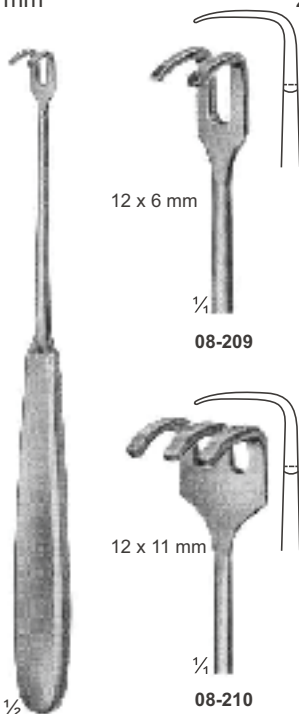

08-209 - 210
Tendon hooks
175 mm

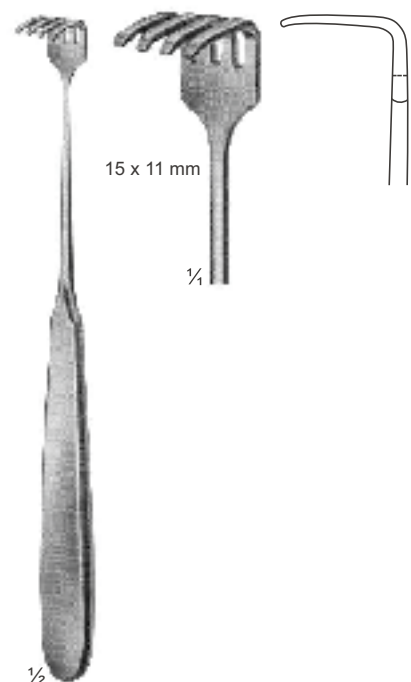

08-211
KLAPP
Tendon hooks
175 mm

Retractors

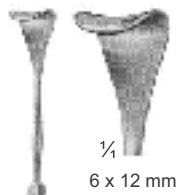

¼
6 x 12 mm

½
08-212
MASING
140 mm

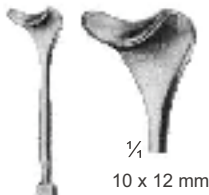

¼
10 x 12 mm

½
08-213
COTTLE
140 mm



08-214
9 x 9 mm



08-215
9 x 12 mm

½
08-214 - 218
DESMARRES
140 mm



¼
08-216
11 x 14 mm



¼
08-217
12 x 16 mm



¼
08-218
13 x 18 mm



¼
08-219
13 x 13 mm



¼
08-220
12 x 16 mm

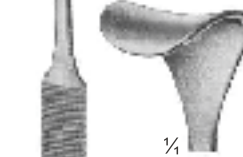

¼
08-221
12 x 16 mm

½
08-219 - 220
KONIG
180 mm

½
08-221
CUSHING-KOCHER
175 mm



½
08-222 - 223
KOCHER
205 mm

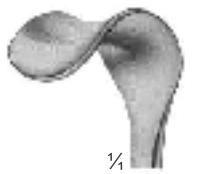

¼
08-222
20 x 12 mm

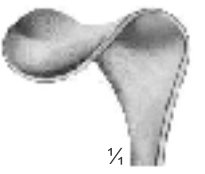

¼
08-223
20 x 15 mm

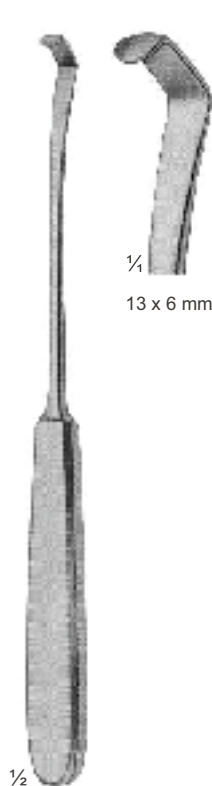

½
08-224
SCHOENBORN
200 mm



¼
08-225
10 x 13 mm



¼
08-226
14 x 18 mm

½
08-225 - 226
CUSHING
205 mm



½
08-227
205 mm



¼
08-228
11 x 14 mm



¼
08-229
13 x 18 mm



¼
08-230
15 x 22 mm

½
08-228 - 230
CUSHING
250 mm

Retractors

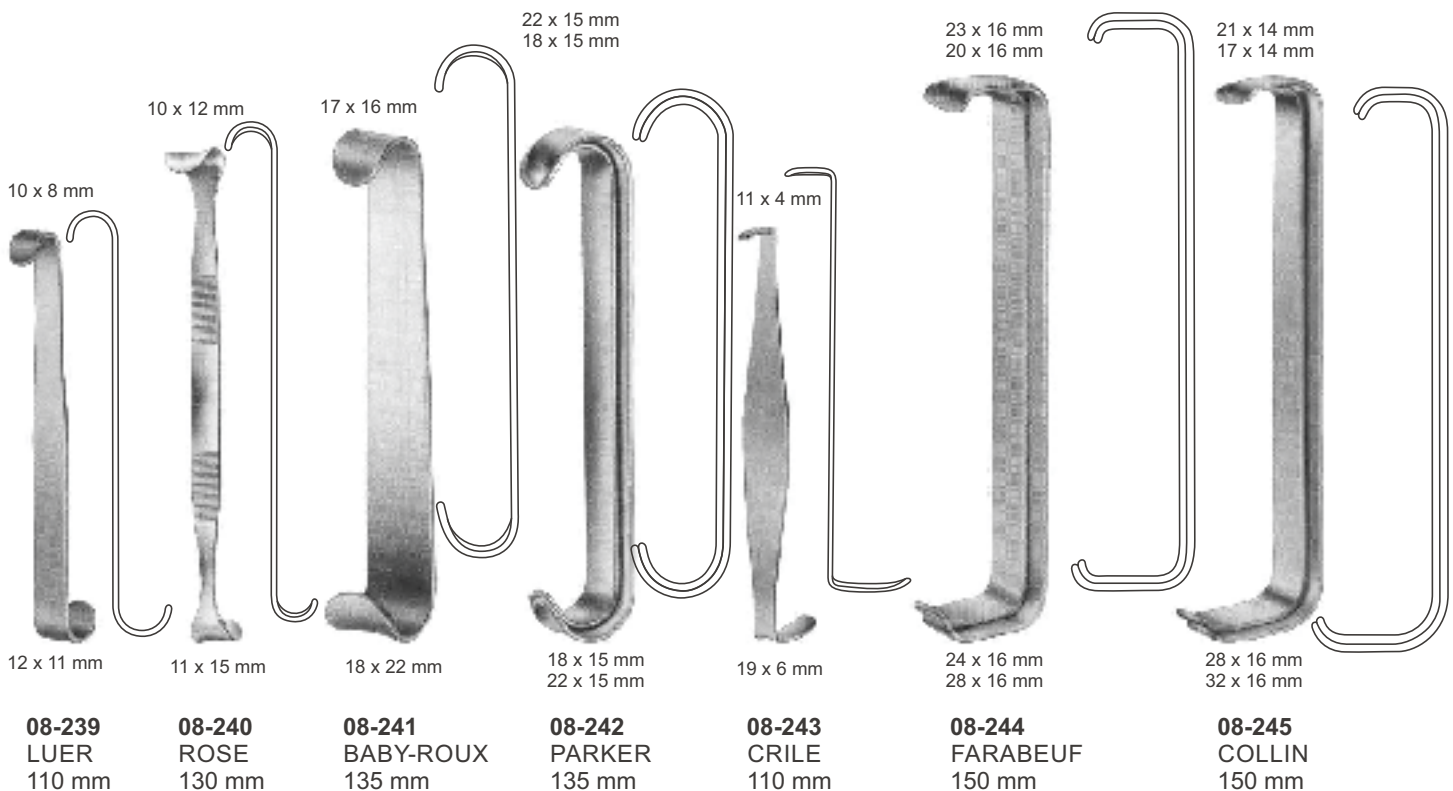

Retractors

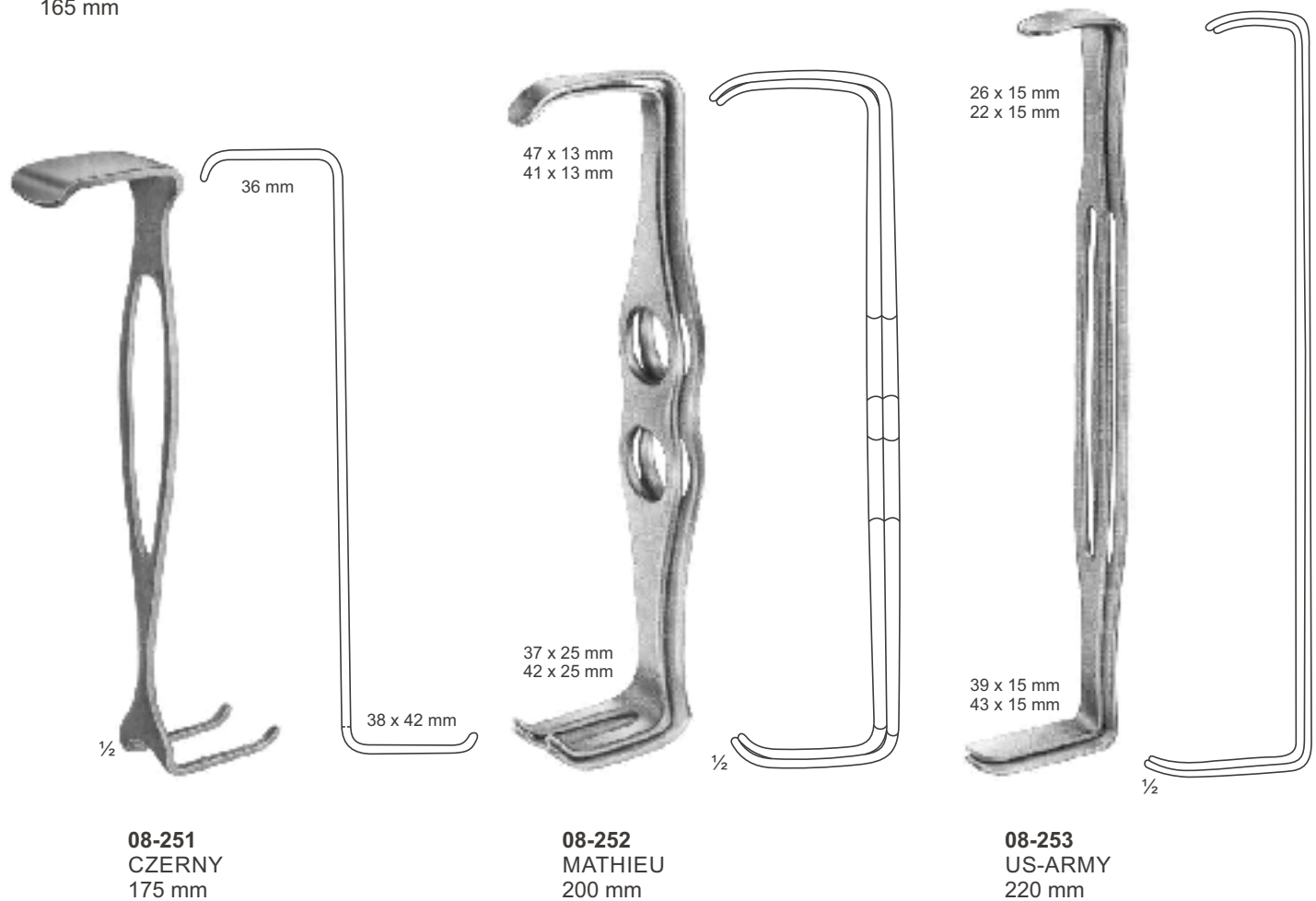
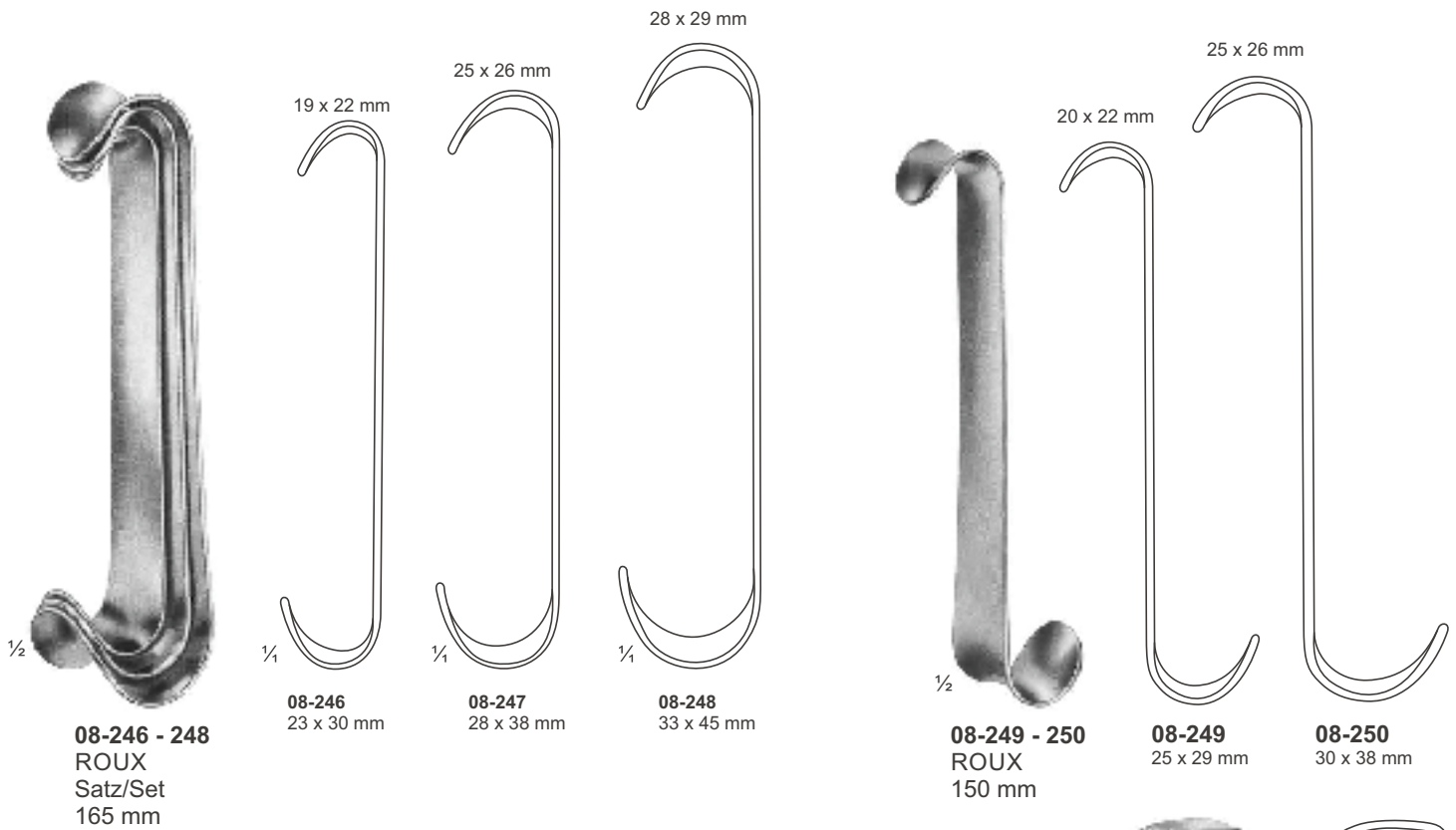

Bone Retractors and Retractors



08-254
KOCHER
Sharp
205 mm



08-255
KOCHER
Sharp
220 mm



08-256
KOCHER
Blunt
220 mm



08-257
VOLKMANN
Sharp
220 mm



08-258
VOLKMANN
Sharp
220 mm



08-259 - 266
VOLKMANN
225 mm

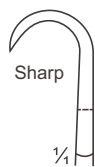

08-259
9 x 8 mm



08-260
9 x 13 mm



08-261
9 x 19 mm



08-262
9 x 29 mm

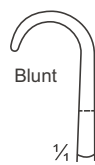

08-263
8,5 x 8 mm



08-264
8,5 x 13 mm



08-265
8,5 x 19 mm



08-266
8,5 x 29 mm

Retractors

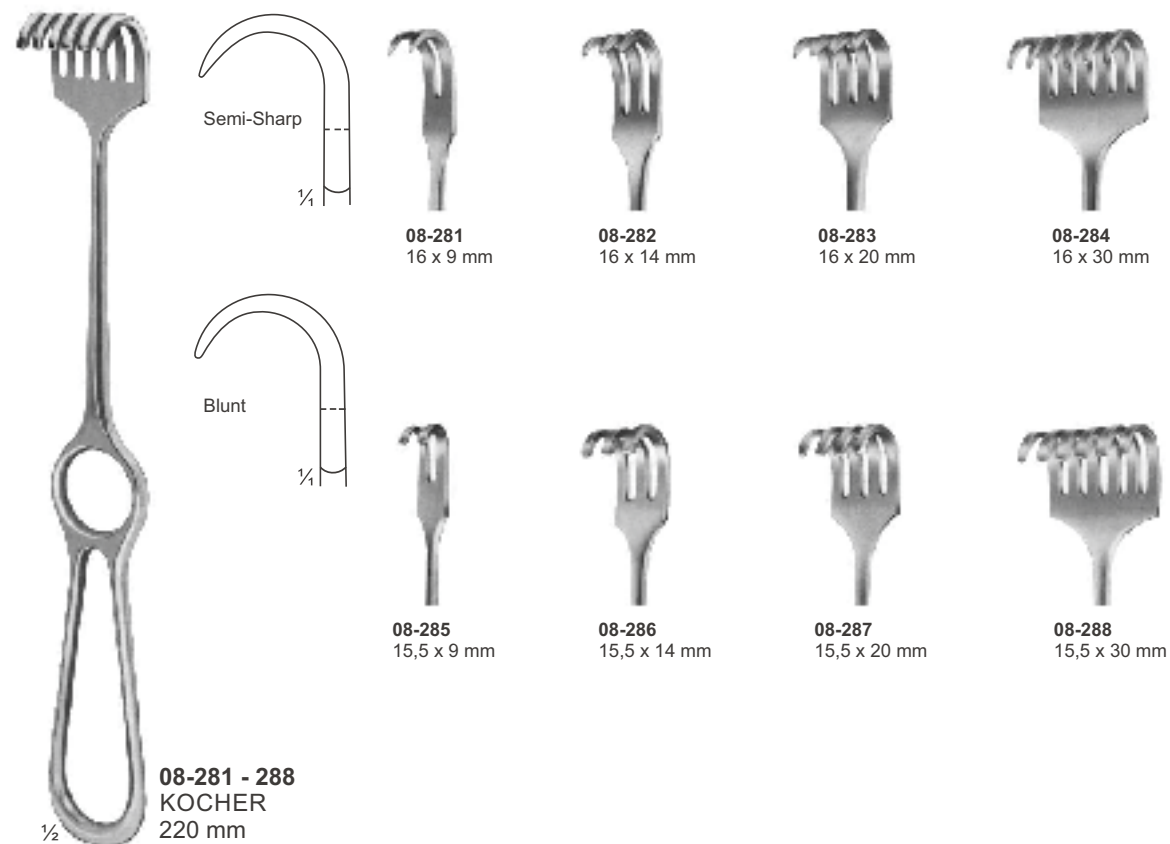
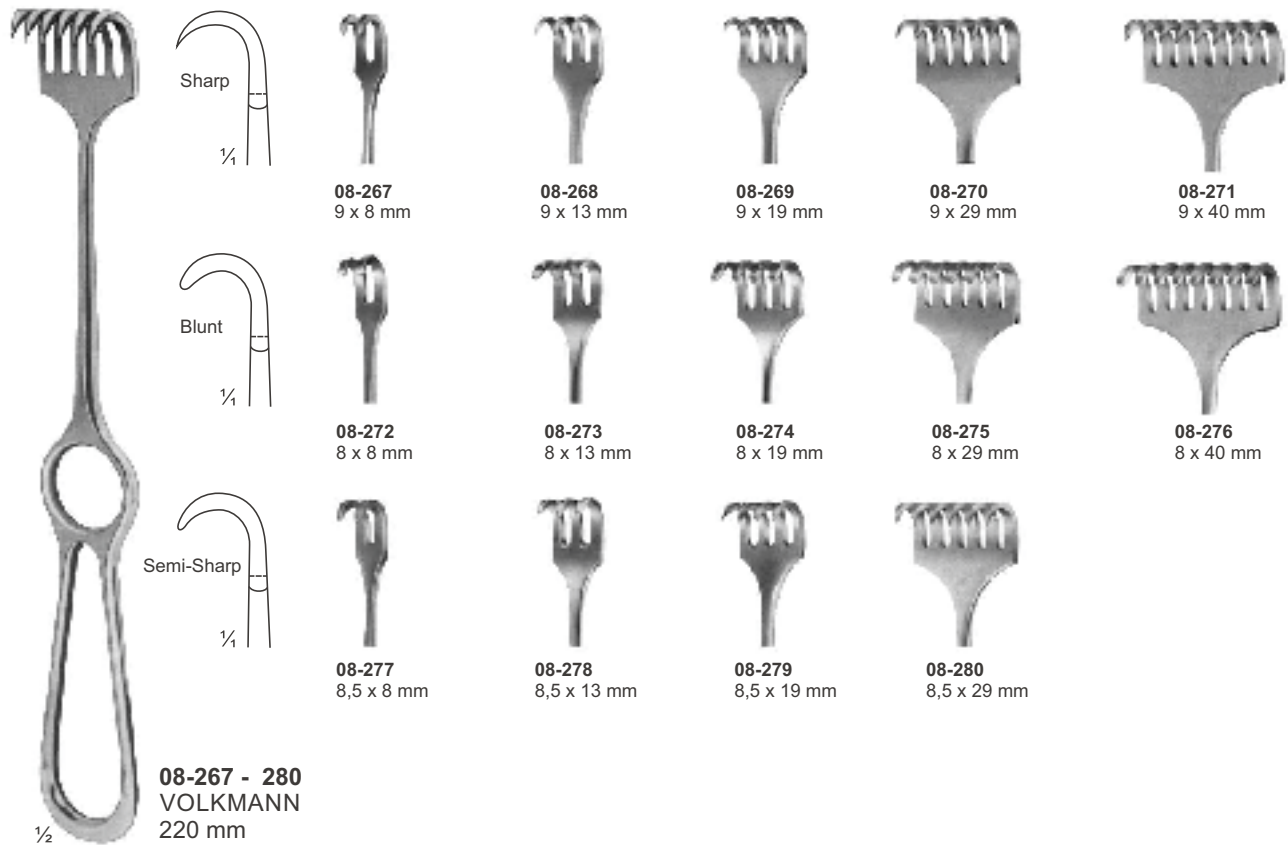

Retractors, Deep form



08-289 - 290
KORTE
240 mm



08-289
8 Prongs, blunt



08-290
8 Prongs, sharp



08-291 - 294
ISRAEL
255 mm

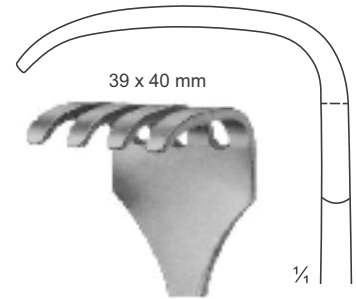

08-291
4 Prongs, blunt

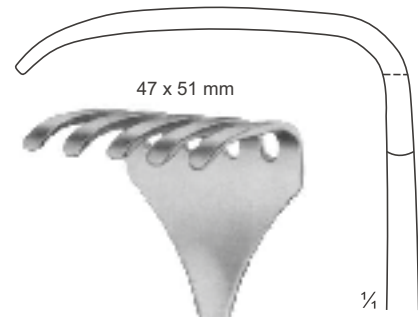

08-292
5 Prongs, blunt

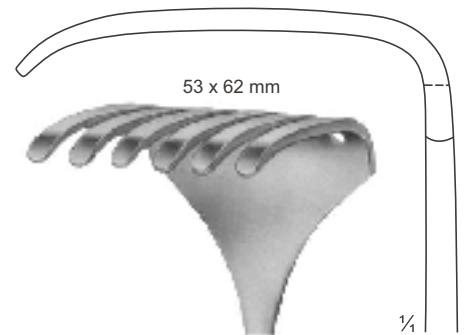

08-293
6 Prongs, blunt

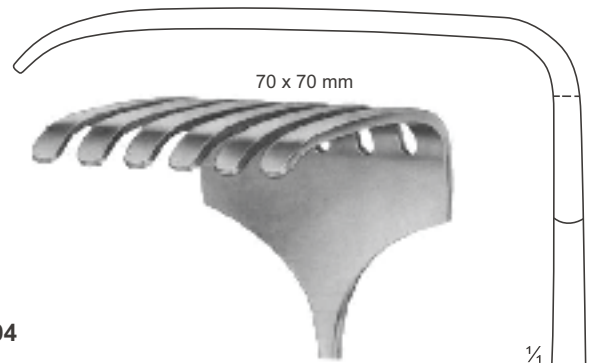

08-294
6 Prongs, blunt

Retractors

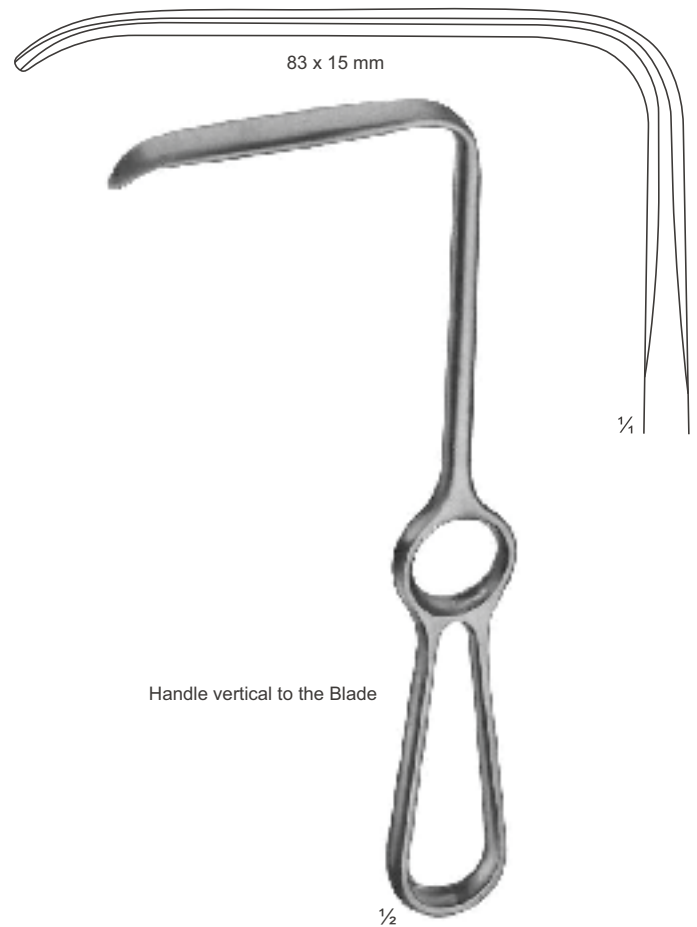

08-295 - 300
LANGENBECK
210 mm

| | |
|---------------|------------|
| 08-295 | 28 x 10 mm |
| 08-296 | 28 x 14 mm |
| 08-297 | 33 x 14 mm |
| 08-298 | 28 x 16 mm |
| 08-299 | 40 x 10 mm |
| 08-300 | 40 x 13 mm |

08-301 - 307
KOCHER-LANGENBECK
215 mm

| | |
|---------------|------------|
| 08-301 | 25 x 6 mm |
| 08-302 | 35 x 8 mm |
| 08-303 | 35 x 11 mm |
| 08-304 | 35 x 15 mm |
| 08-305 | 41 x 11 mm |
| 08-306 | 55 x 11 mm |
| 08-307 | 70 x 14 mm |

08-308
LANGENBECK
215 mm

Retractors



08-309 - 313
KOCHER
230 mm

1/2



08-314 - 316
SAUERBRUCH
225 mm

1/2

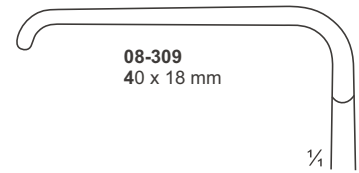

08-309
40 x 18 mm

1/4

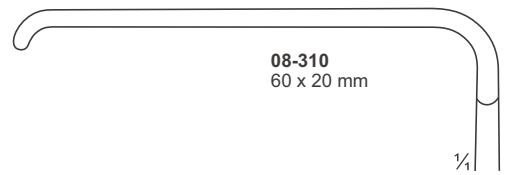

08-310
60 x 20 mm

1/4

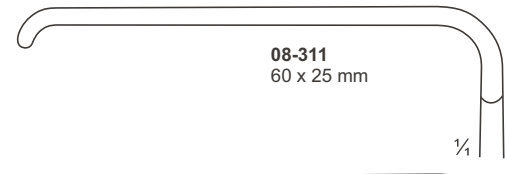

08-311
60 x 25 mm

1/4

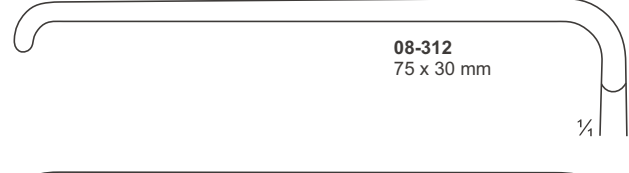

08-312
75 x 30 mm

1/4

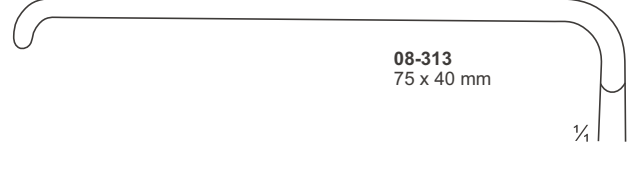

08-313
75 x 40 mm

1/4

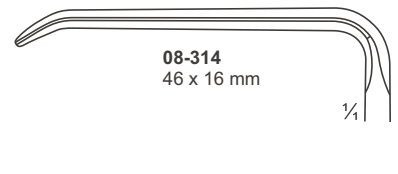

08-314
46 x 16 mm

1/4

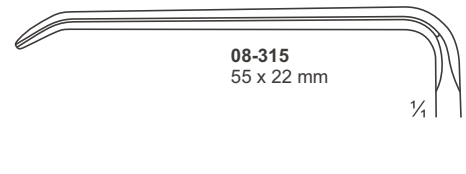

08-315
55 x 22 mm

1/4

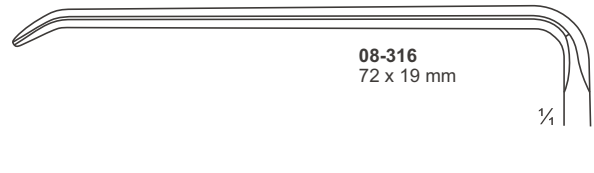

08-316
72 x 19 mm

1/4

Retractors

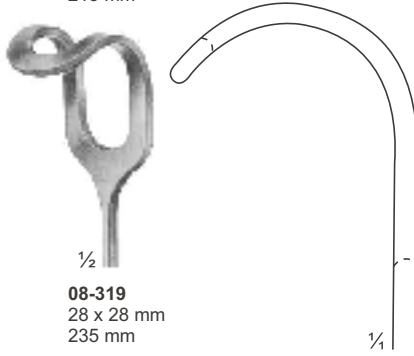
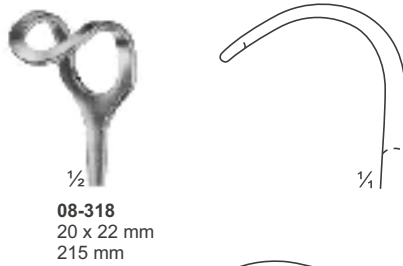

08-317 - 319
MIDDELDORPF



08-320
BUCHS
205 mm



1/2
08-321
CASPAR
210 mm

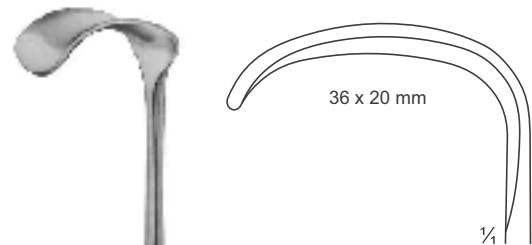

1/2
08-322
KOCHER
230 mm

Retractors



1/2

08-323 - 328
HOSEL
250 mm

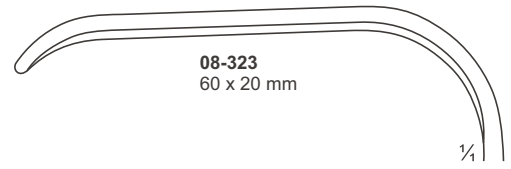

08-323
60 x 20 mm

1/4

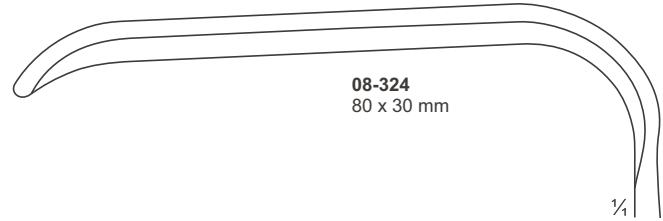

08-324
80 x 30 mm

1/4

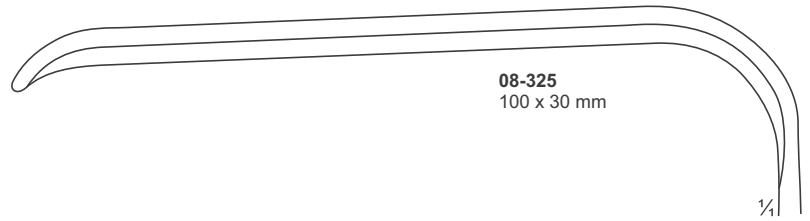

08-325
100 x 30 mm

1/4

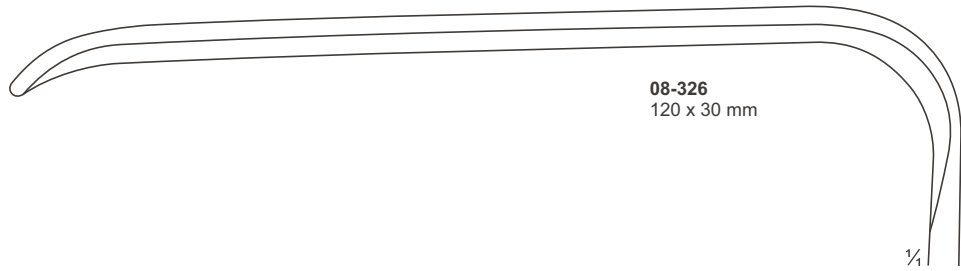

08-326
120 x 30 mm

1/4

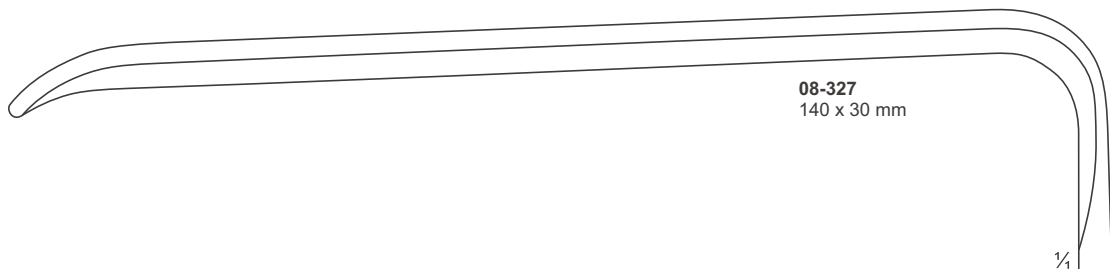

08-327
140 x 30 mm

1/4

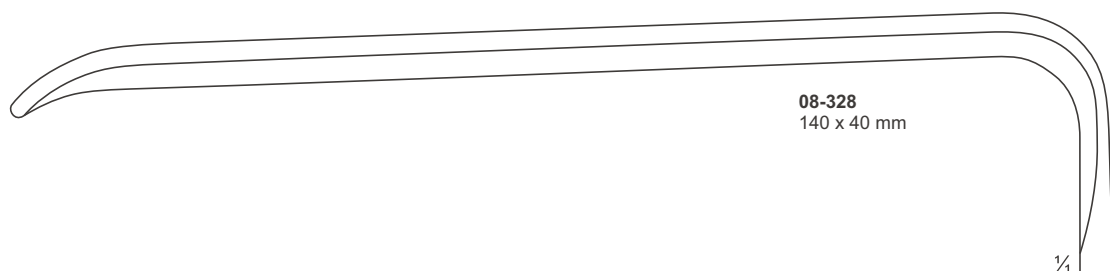

08-328
140 x 40 mm

1/4

Retractors

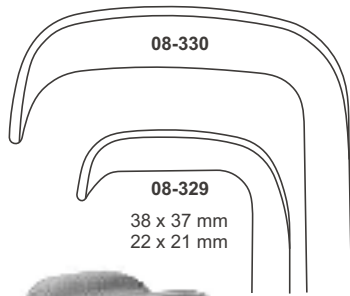

08-329
38 x 37 mm
22 x 21 mm

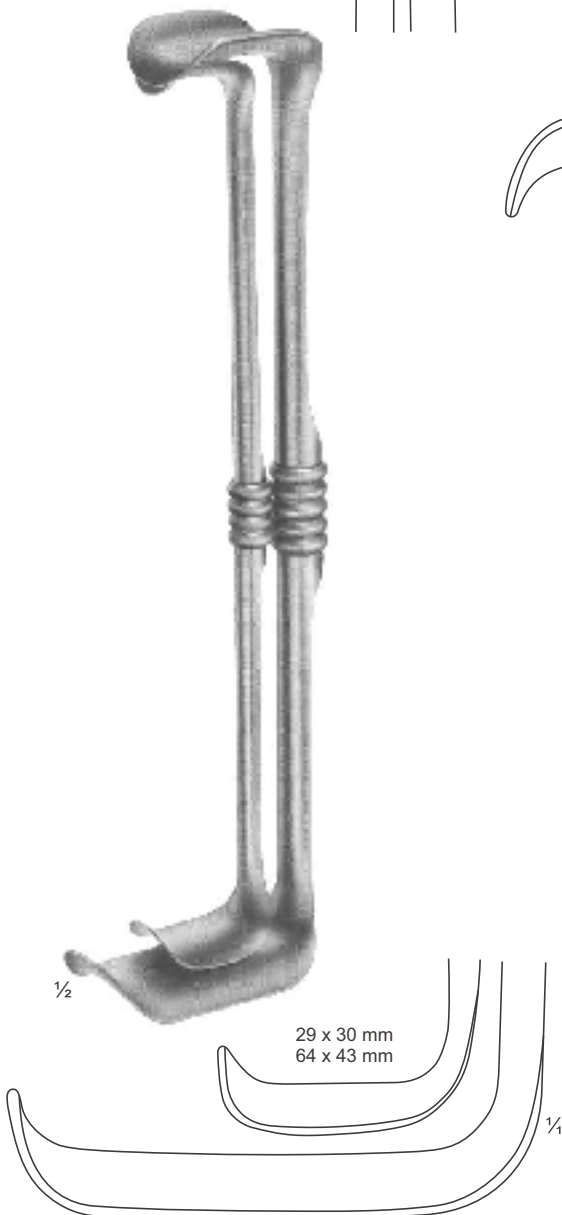
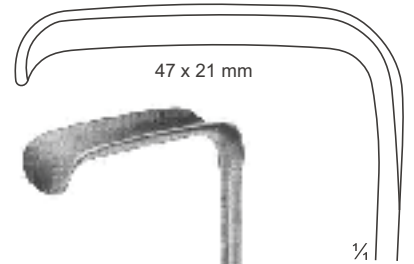
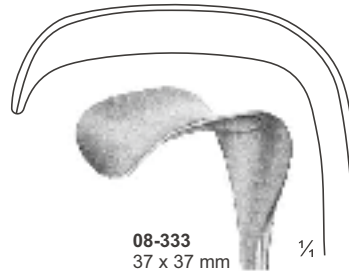

08-329 - 230
RICHARDSON-EASTMAN
Set-250 mm

08-329 250 mm
08-330 270 mm



08-331 - 333
RICHARDSON
240 mm

1/2

08-334
RICHARDSON
240 mm

Retractors

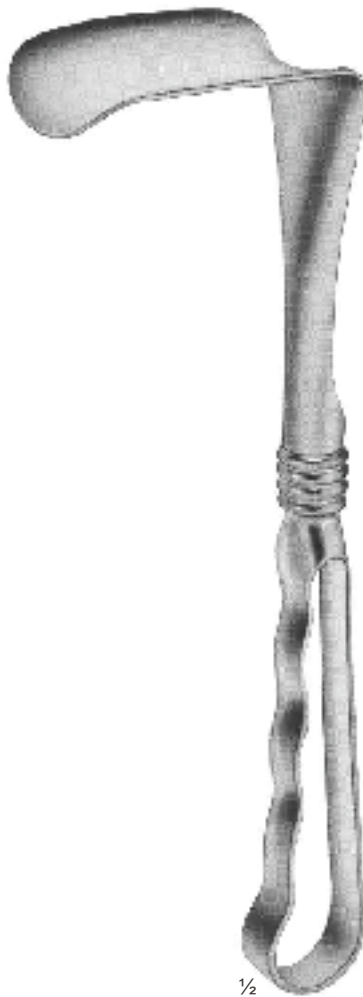
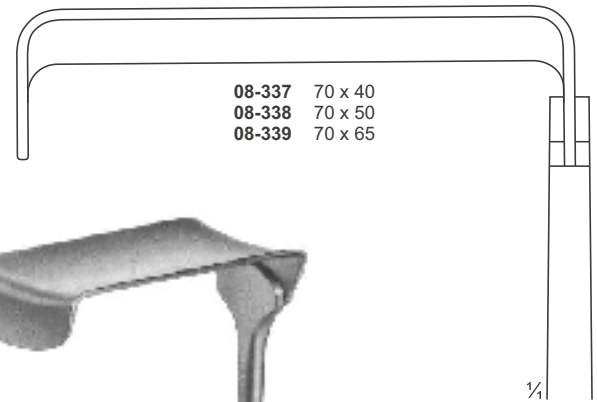
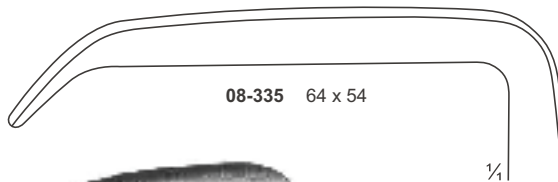
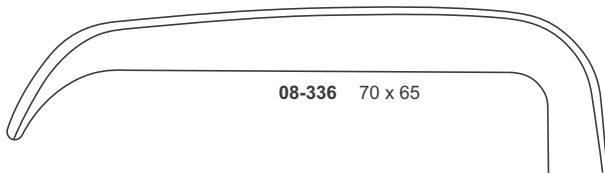

08-335 - 336
KELLY
260 mm



08-337 - 339
MORRIS
245 mm

Retractors For Deep Surgery



Retractors For Deep Surgery

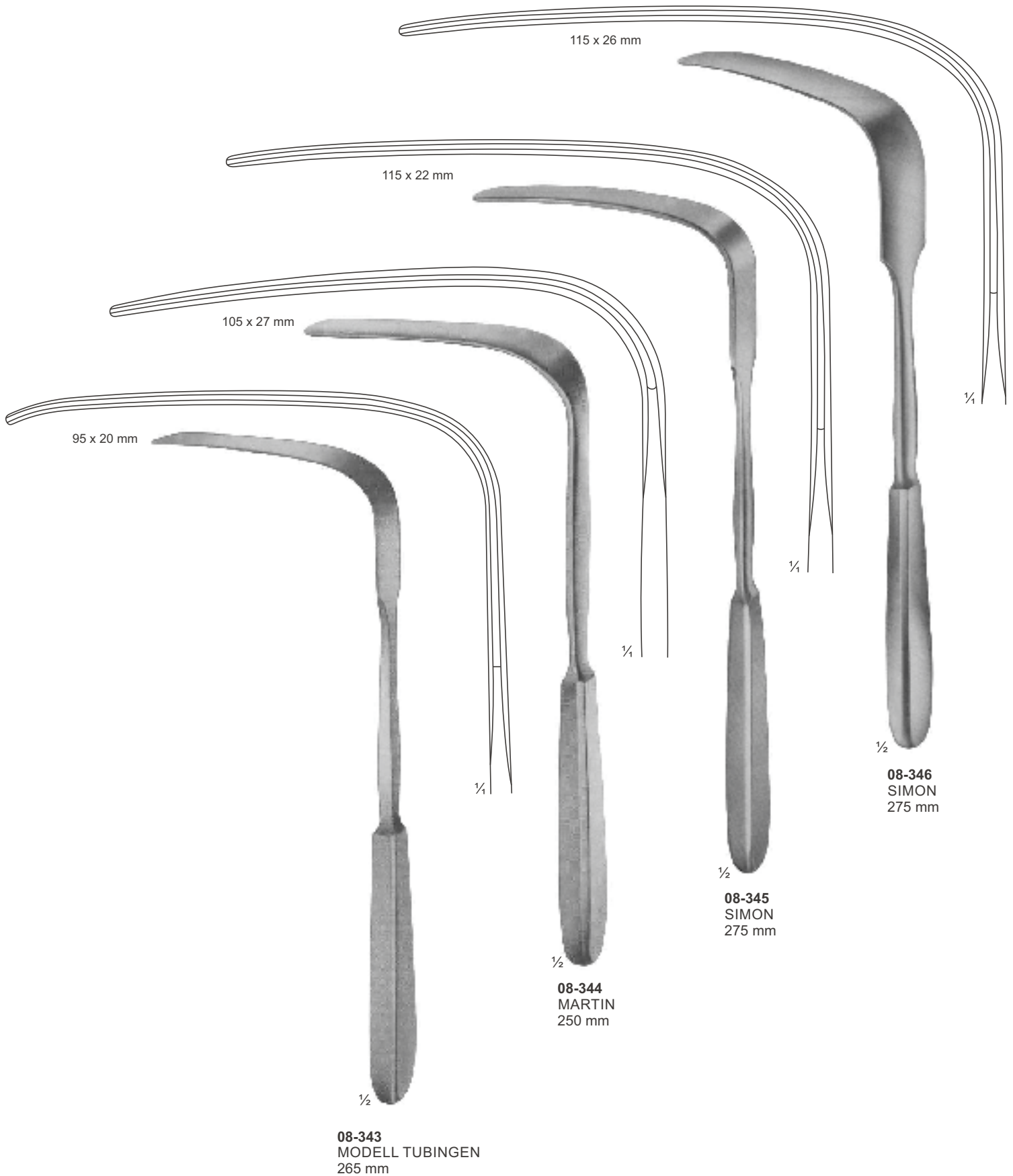

Vario Retractor System, Germ. Fed. Patent,
Germ. Fed. Regd.Des.

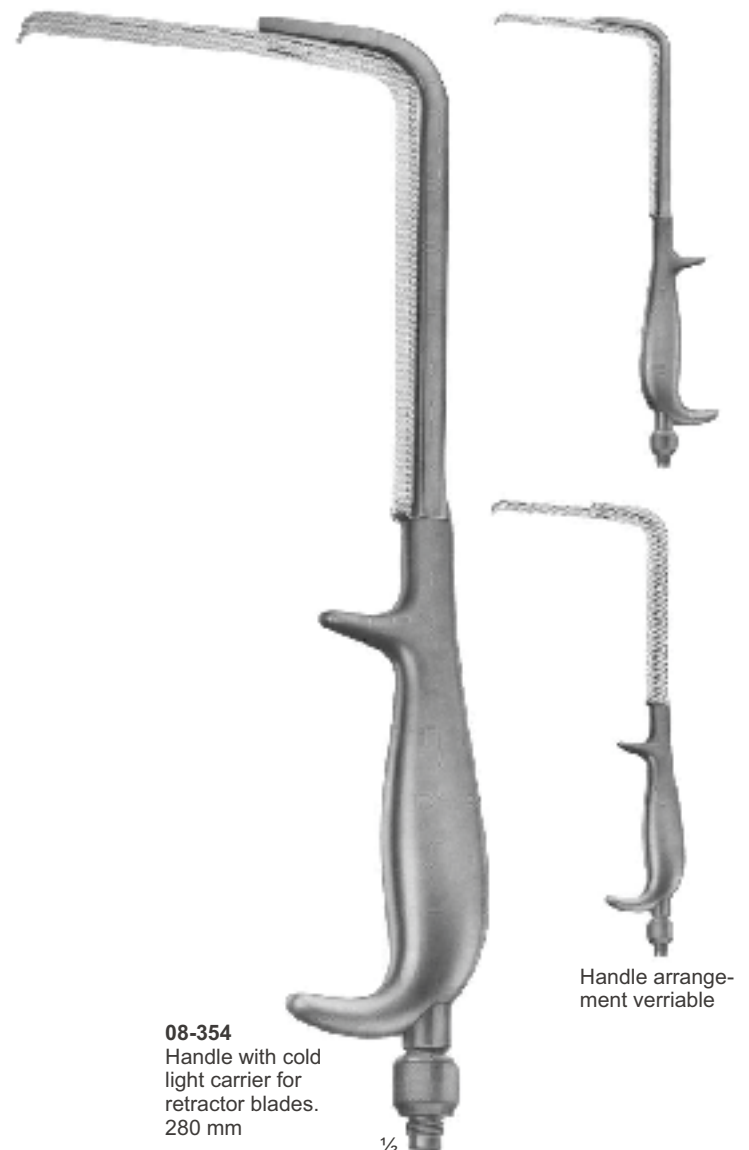

Retractors, Lung Spatulas

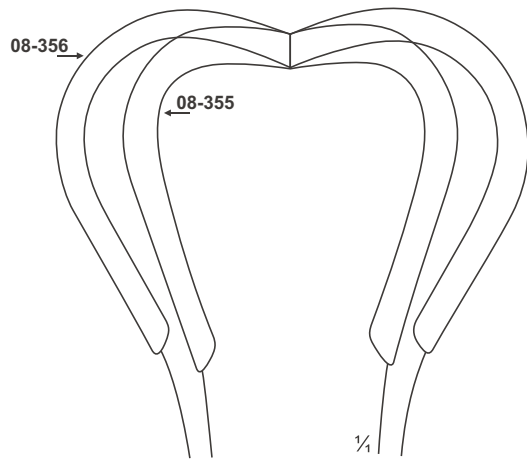

08-355 - 356
HARRINGTON
08-355 123 x 45 mm
08-356 123 x 64 mm
Flexible
295 mm



08-357
ALLISON
255 mm



08-358
ALLISON
320 mm

Retractors, Lung Spatulas



Retractors, Lung Spatulas

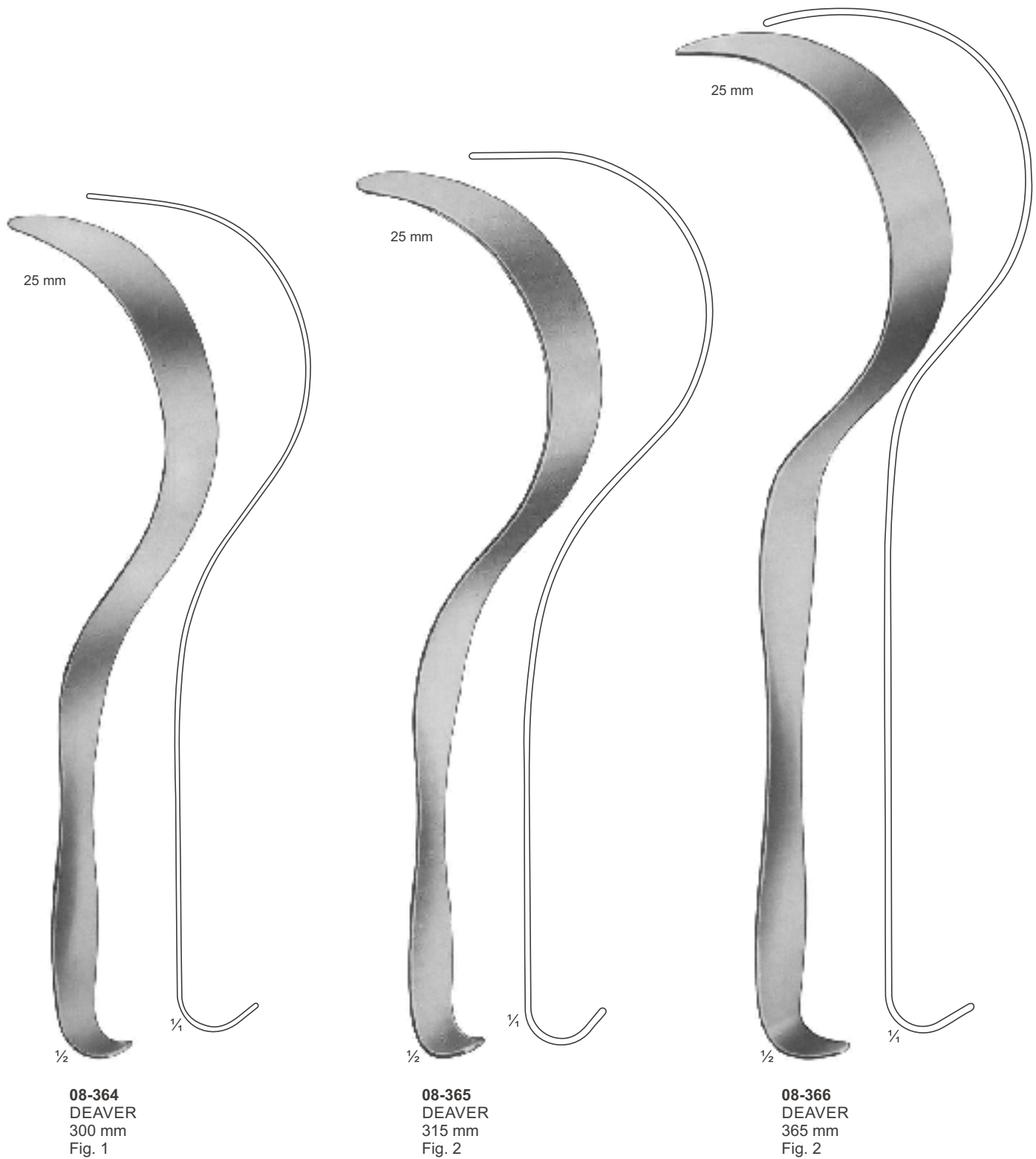

Retractors, Lung Spatulas



08-367
DEAVER
300 mm
Fig. 3

08-368
DEAVER
310 mm
Fig. 4

08-369
DEAVER
320 mm
Fig. 5

Retractors, Lung Spatulas

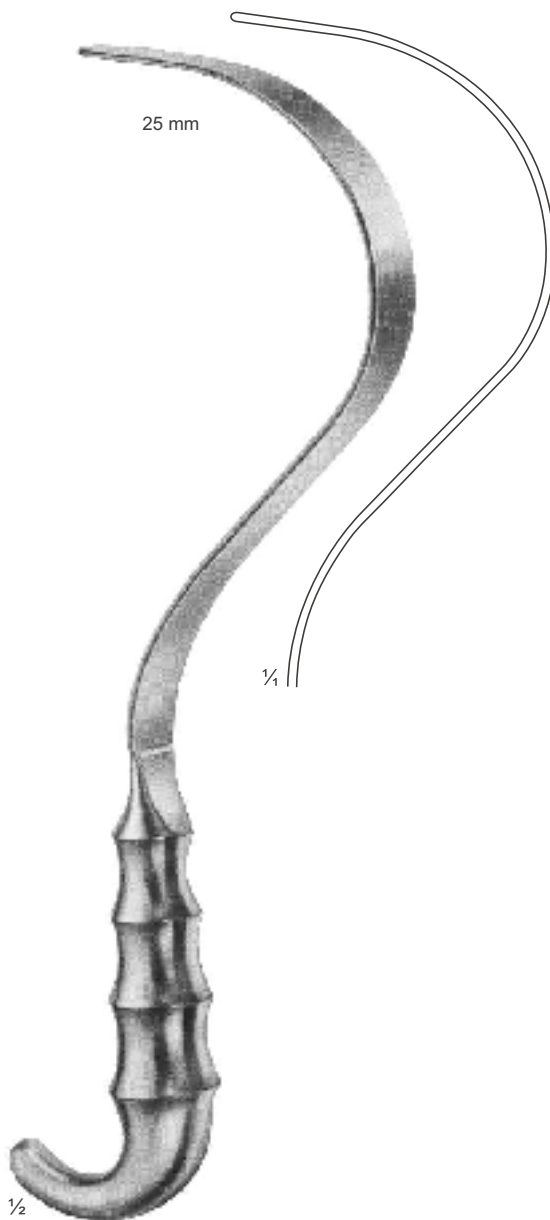

08-370
DEAVER
310 mm
Fig. 1

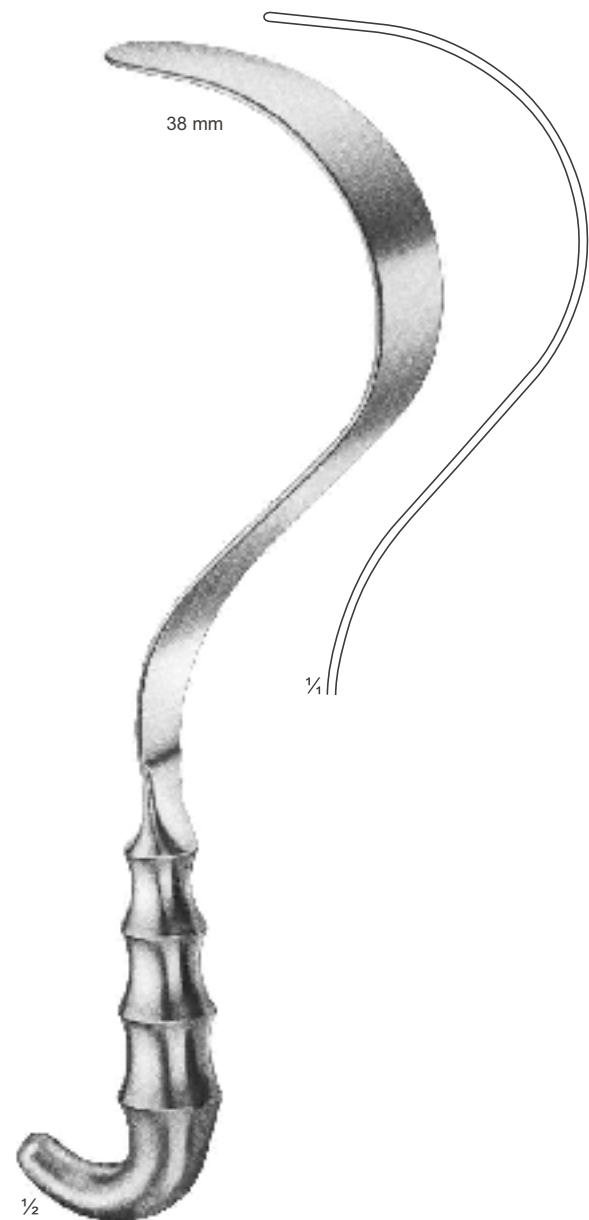

08-371
DEAVER
310 mm
Fig. 3

Retractors, Lung Spatulas



08-372
DEAVER
305 mm
Fig. 3



08-373
DEAVER
310 mm
Fig. 4

Retractors For Deep Surgery (Abdominal Retractors)

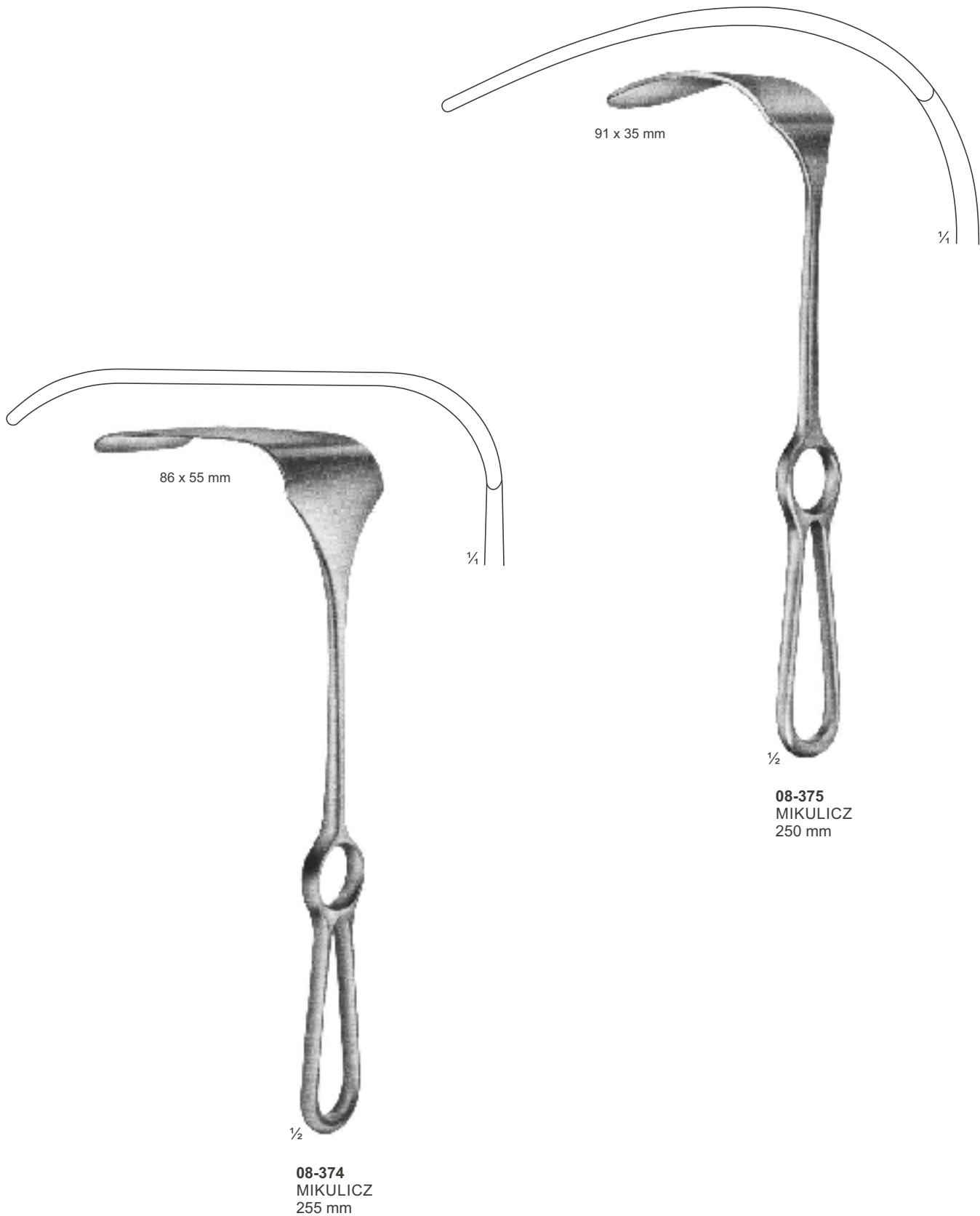

Retractors For Deep Surgery (Abdominal Retractors)

08-378 150 x 39 mm
08-379 150 x 57 mm

08-376 121 x 50 mm
08-377 147 x 50 mm

08-378 - 379
KELLY
08-378 150 x 39 mm
08-379 150 x 57 mm
260 mm

08-376 - 377
MIKULICZ
08-376 121 x 50 mm
08-377 147 x 50 mm
Liver Retractor
250 mm

1/2

1/4

1/2

Retractors, Abdominal Retractors

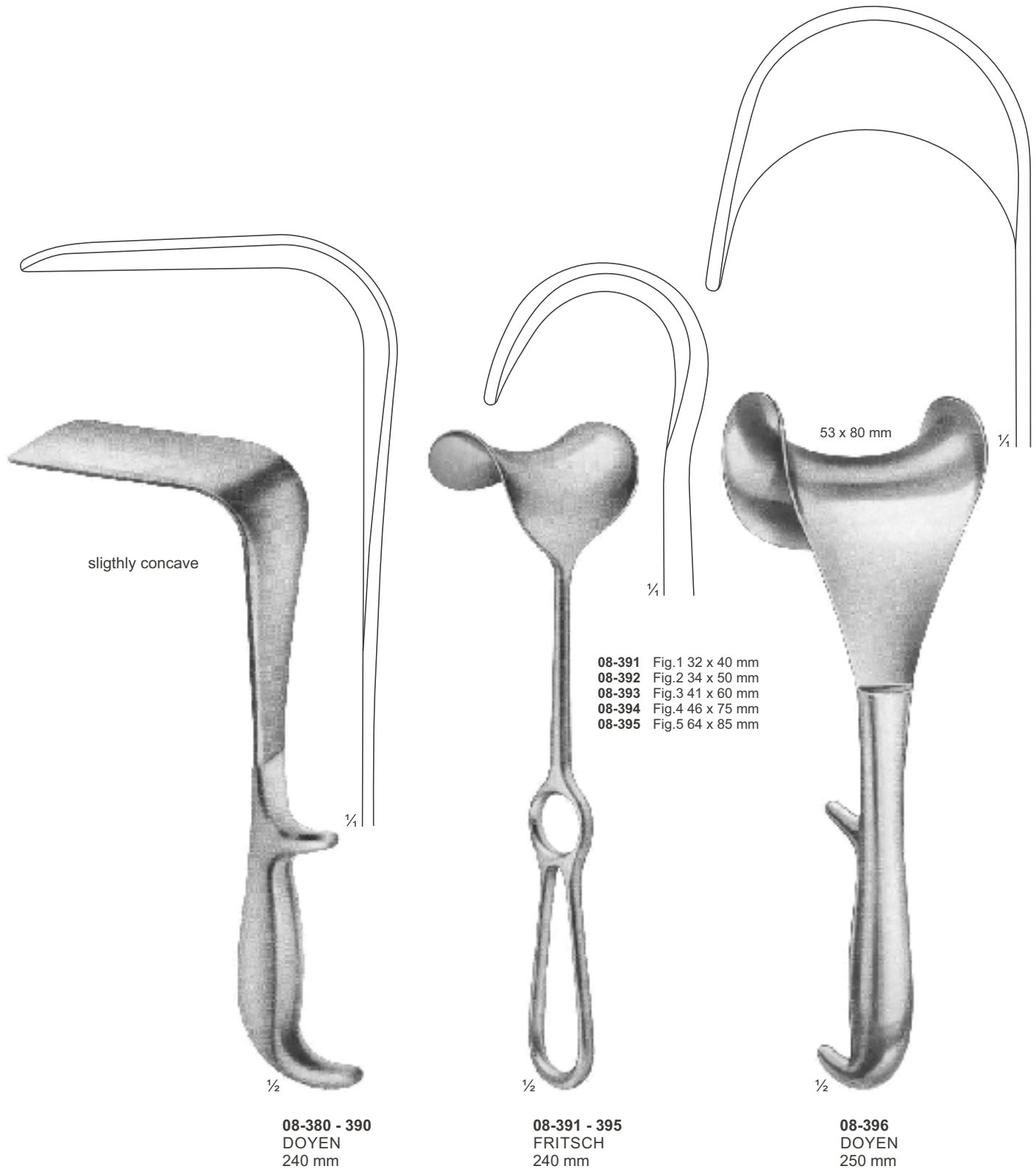

Width of Blades
35 mm, 45 mm, 60 mm

Length of Blades

| | |
|--------|------------------------|
| 62 mm | 08-380, 08-381, 08-382 |
| 92 mm | 08-383, 08-384, 08-385 |
| 122 mm | 08-386, 08-387, 08-388 |
| 160 mm | 08-389, 08-390 |

Abdominal Retractors



08-397 - 401
ROCHARD
310 mm
08-397 48 x 90 mm
08-398 48 x 105 mm
08-399 48 x 120 mm
08-400 48 x 135 mm
08-401 48 x 155 mm

1/3



1/3

08-402



08-403 - 406
DOYEN
280 mm
08-403 48 x 90 mm
08-404 48 x 105 mm
08-405 48 x 120 mm
08-406 48 x 135 mm

1/3



1/3

08-407
DOYEN-CHILD
Fixation device
220 mm



08-408
Chain with
weight (747 / 645g)
790 mm

Pelvis Retractors

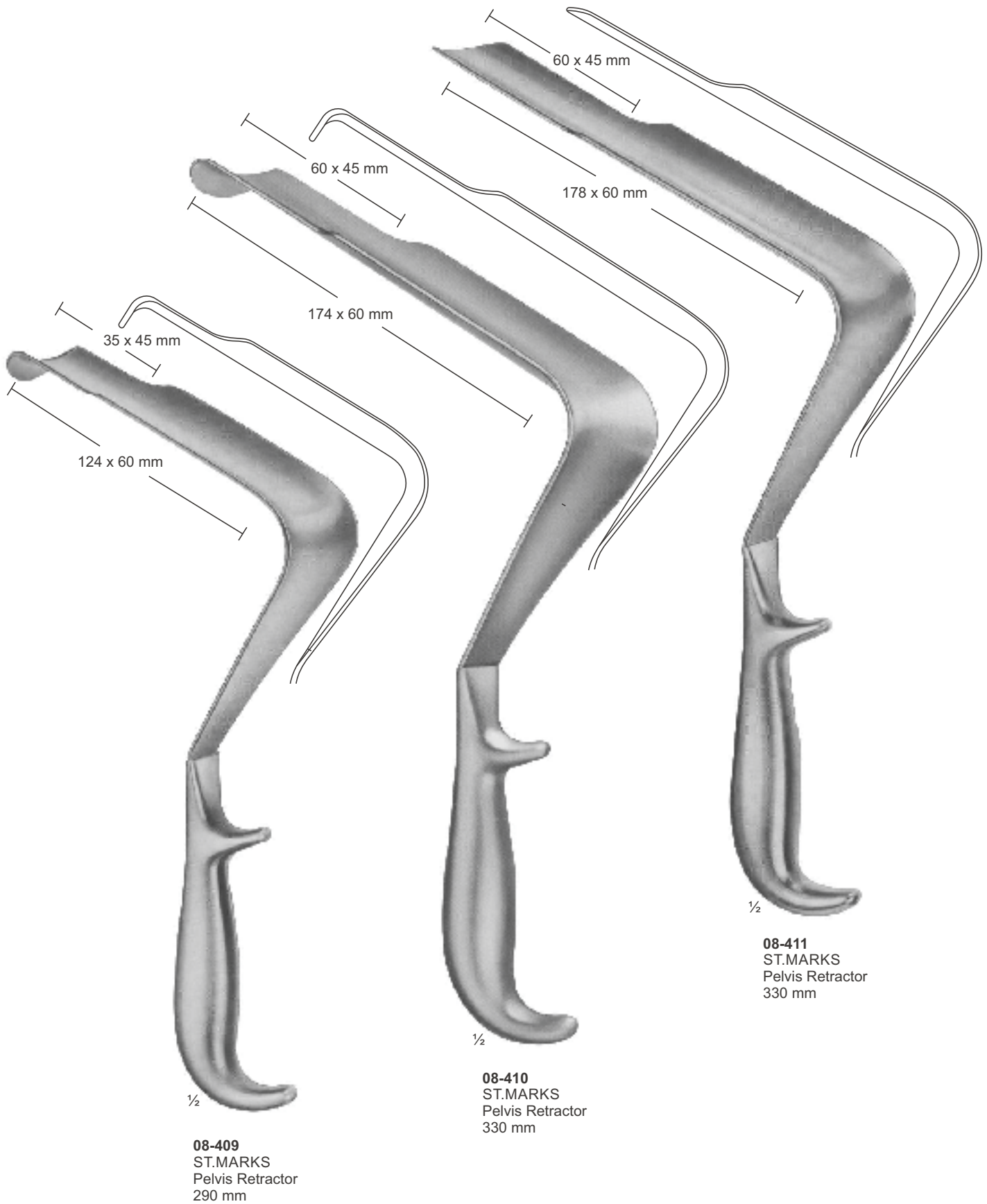

Abdominal- and Intestinal Spatulas



08-412
LERICHE
255 mm

08-413
KUMMEL
Melleable
285 mm

08-414
MIKULICZ
29 mm
250 mm

08-415 - 416
KADER
08-415 30 mm
08-416 40 mm
270 mm

Abdominal- and Intestinal Spatulas



08-417
REVERDIN
285 mm



08-418
HABERER
Malleable
305 mm



08-419 30 mm
08-420 40 mm
08-421 50 mm
Malleable
330 mm



08-422
TUFFIER
Malleable
200 mm

Self-Retaining Retractors



08-423
BOSE
60 mm



08-424
FINSEN
50 mm



08-425
FINSEN
70 mm



08-426
FINSEN modif.
75 mm

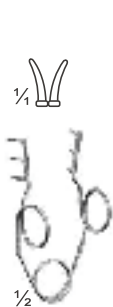

08-427
45 mm

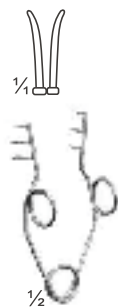

08-428
55 mm



08-429
MUELLER
65 mm



08-430
100 mm



08-431



08-432



08-431 - 432
ALM
08-431 70 mm
08-432 100 mm

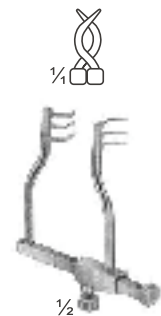

08-433
LOGAN
modif. REILL
50 mm



08-434
JANSSEN
100 mm



08-435
JANSSEN
100 mm

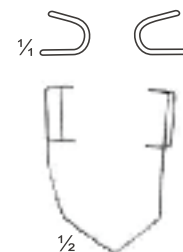

08-436
BARRAQUER
45 mm

Self-Retaining Retractors



08-437
WEITLANER
Sharp
110 mm



08-438
WEITLANER
Semi-Sharp
110 mm



08-439
WEITLANER
Blunt
110 mm



08-440
WEITLANER
Sharp
130 mm



08-441
WEITLANER
Semi-Sharp
130 mm



08-442
WEITLANER
Blunt
130 mm

Self-Retaining Retractors

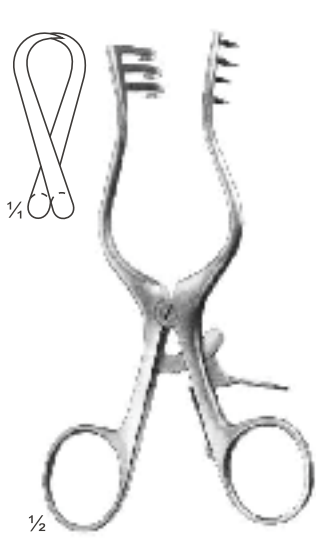

08-443
WEITLANER
Sharp
130 mm

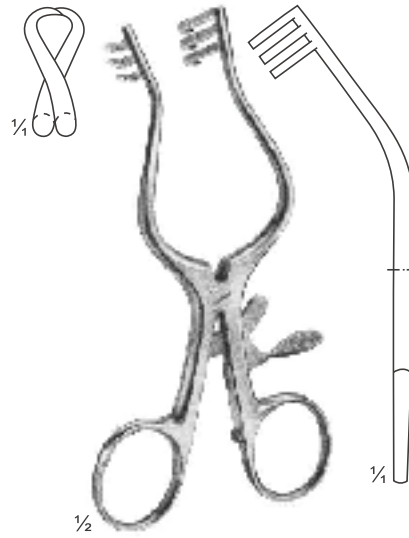

08-444
WULLSTEIN
Sharp
130 mm

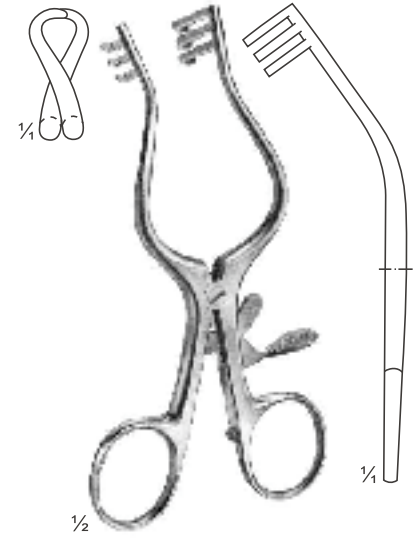

08-445
WULLSTEIN
Blunt
130 mm

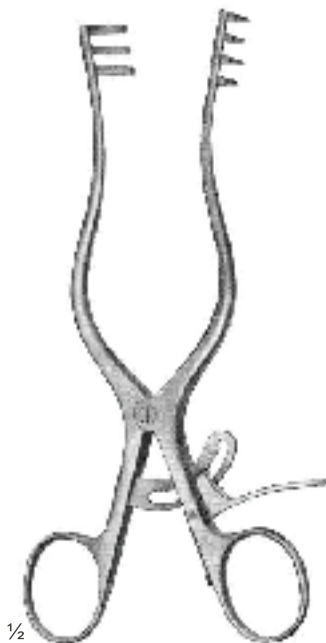

08-446
WEITLANER
Sharp
165 mm

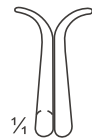

08-447
PLESTER
Blunt
110 mm

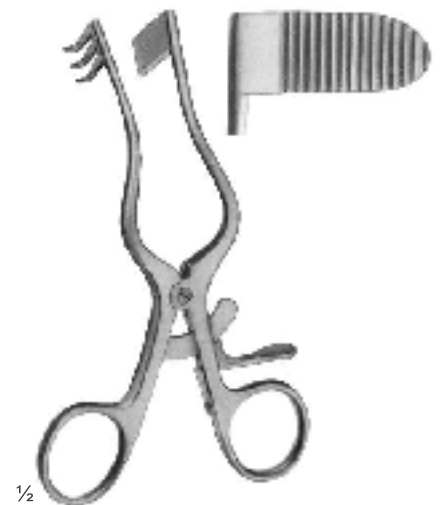

08-448
PERKINS
130 mm

Self-Retaining Retractors



08-449
ADSON-BABY
Blunt
140 mm

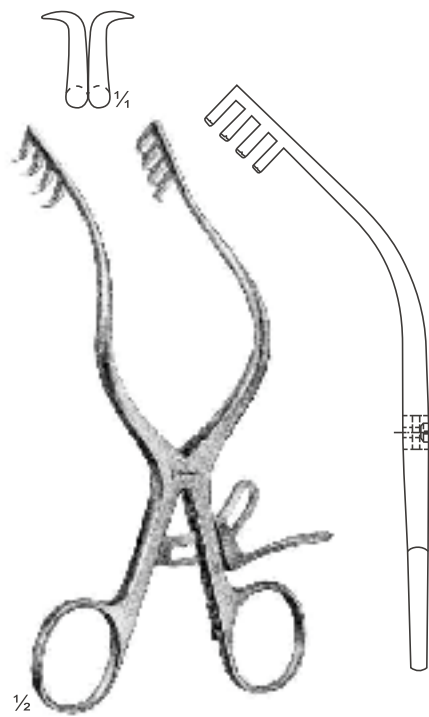

08-450
MOLLISON
Sharp
155 mm

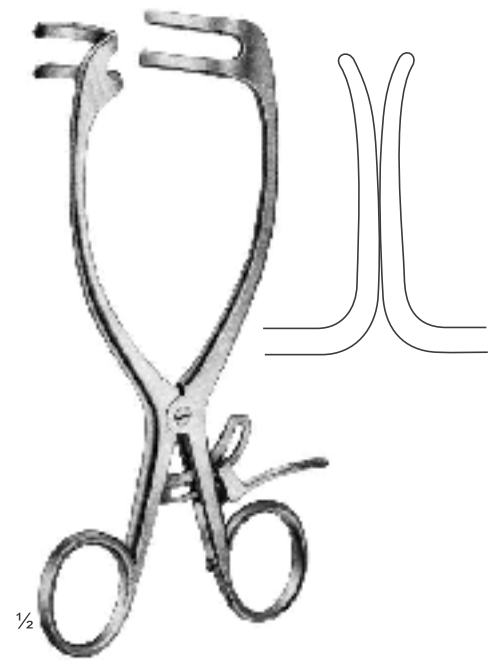

08-451
MAYO-ADAMS
165 mm

Self-Retaining Laminectomy Retractors

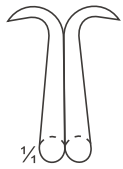

08-452
ANDERSON-ADSON
Sharp
190 mm



08-453
NORFOLK and
NORWICH
Blunt
220 mm



08-454
ADSON
Sharp
265 mm

Self-Retaining Laminectomy Retractors

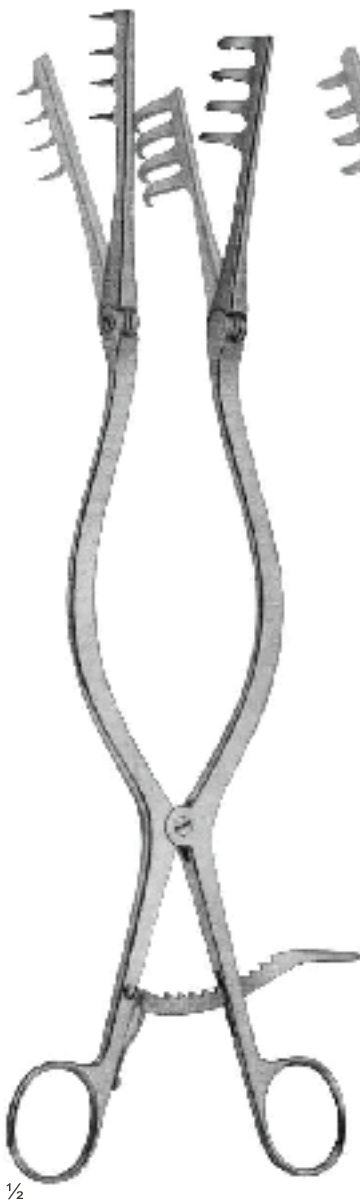
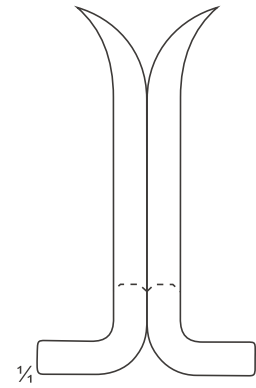
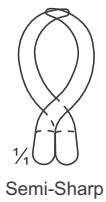
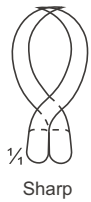

08-455 - 456
BECKMANN-ADSON
Sharp
310 mm



08-456
BECKMANN-ADSON
Semi-Sharp
310 mm

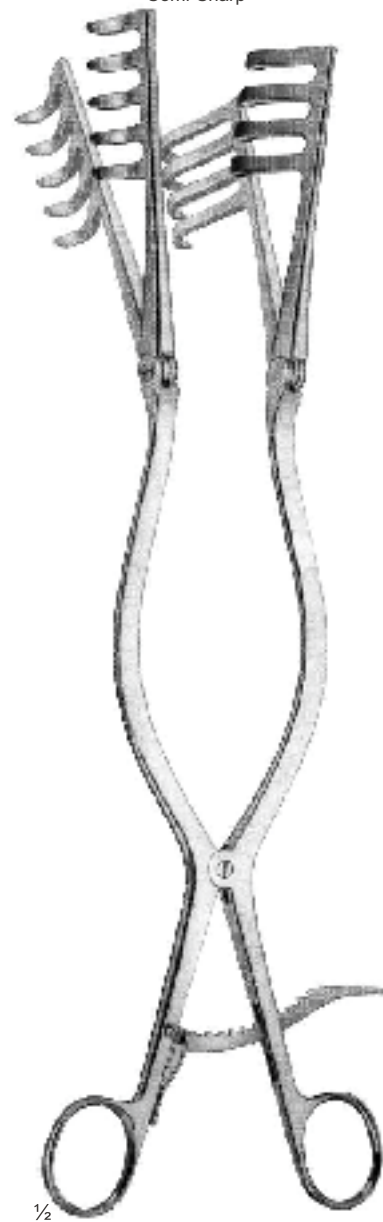

08-457
ADSON
Semi-Sharp
320 mm

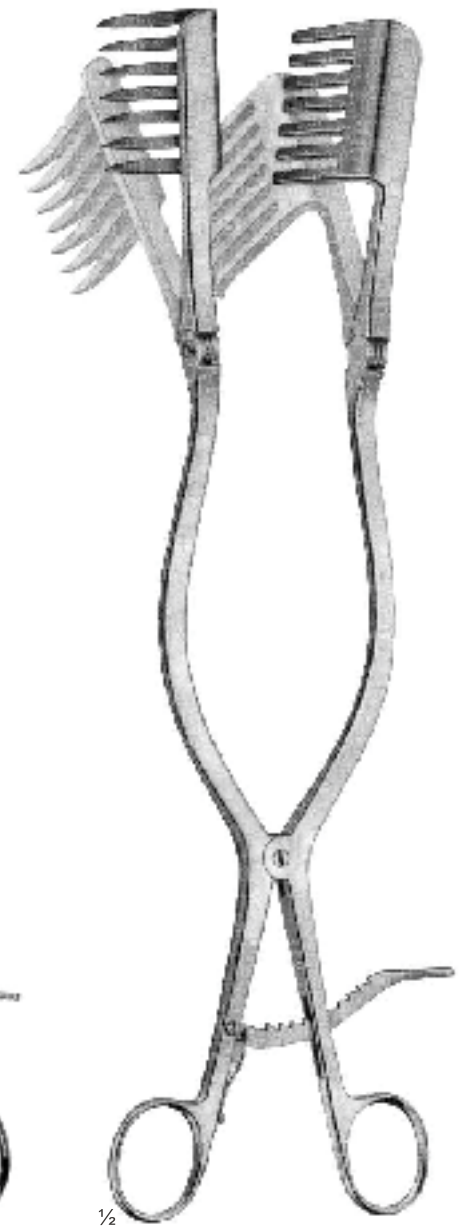

08-458
BECKMANN-EATON
Sharp
320 mm

Special Retractors



1/2

08-459
JOLL (FRIEDMAN)
Thyroid- and Vaginal Retractor
155 mm

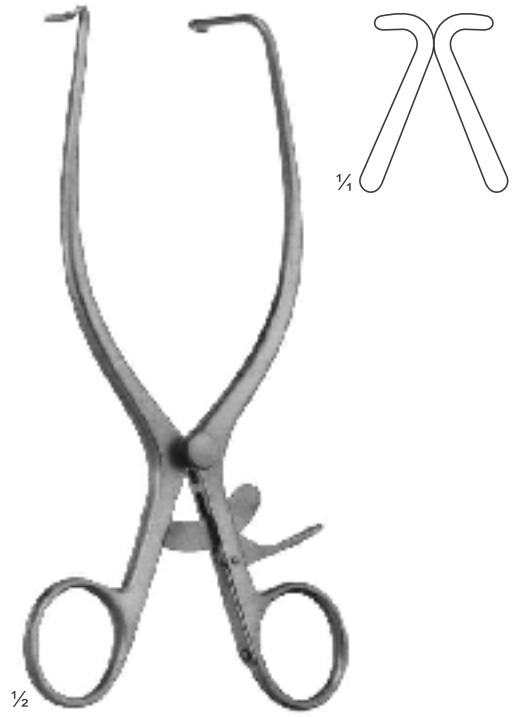

1/2

08-460
JACKSON BURROWS
Retractor, blunt
185 mm

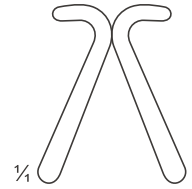

1/4

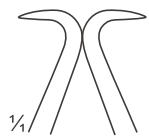

1/4



1/2

08-461
GELPI
Vaginal Retractor
135 mm

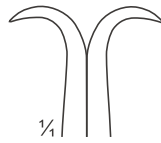

1/4



1/2

08-462
GELPI
Skin- and Vaginal Retractor
175 mm

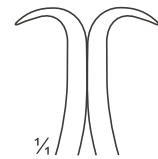

1/4



1/2

08-463
DE BAKEY
Femur Retractor
145 mm

Self Retaining Retractors for Laminectomy and other Operations

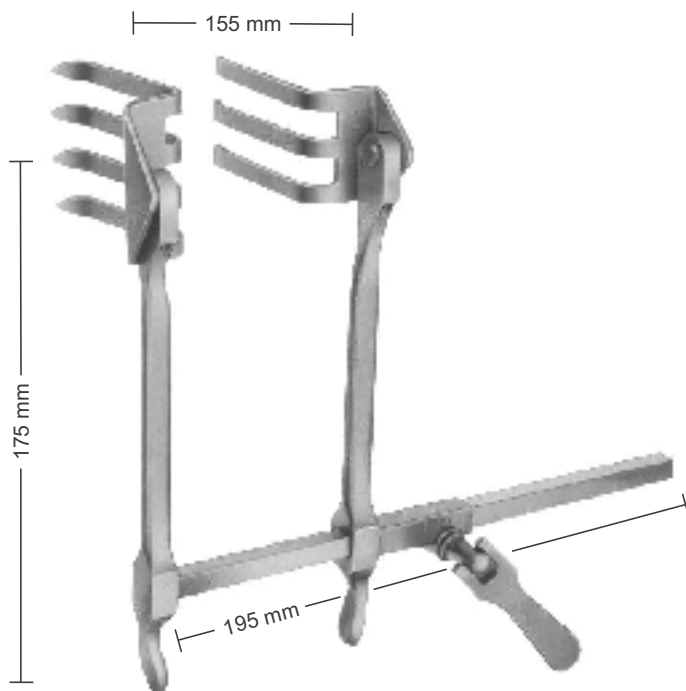

08-464 - 468
SCOVILLE-RICHTER
Retractor with 1 pair
blades reversible type.
The Retractor bar and
shanks may be easily
rotated 180° when
blades are in situ.



08-465
62 x 52 mm 62 x 37 mm
PR= Pair



08-466
47 x 51 mm



08-467
30 x 40 mm



08-468
37 x 62 mm

Retractors for Cervical Spine



08-469
CLOWARD modif.
Spreader Only



16 mm
08-470



16 mm
08-471



16 mm
08-475

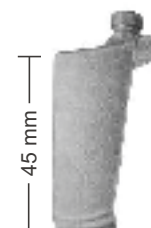

16 mm
08-476

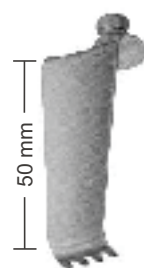

16 mm
08-472

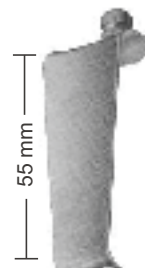

16 mm
08-473

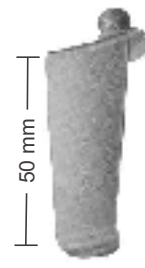

16 mm
08-477

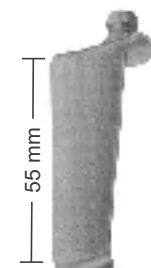

16 mm
08-478

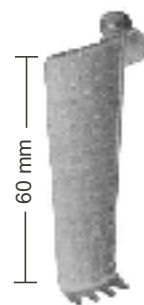

16 mm
08-474

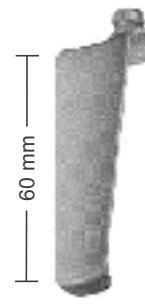

16 mm
08-479

08-470 blade
08-471 blade
08-472 blade
08-473 blade
08-474 blade

08-475 blade
08-476 blade
08-477 blade
08-478 blade
08-479 blade

Retractors for Cervical Vertebral Column

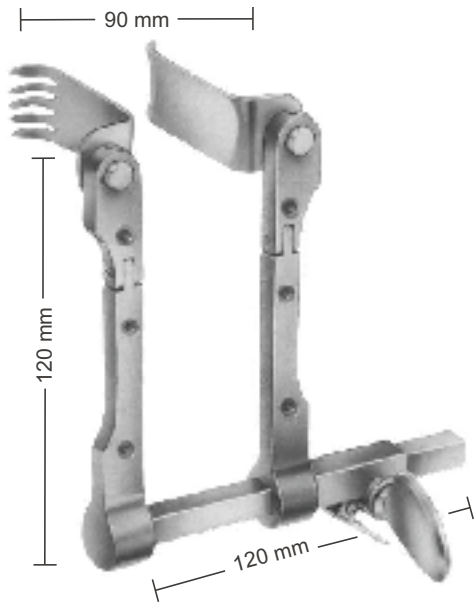

08-480
CASPAR
Retractor, adjustable,
consisting of: 5 medial
blades, 5 Lateral blades.

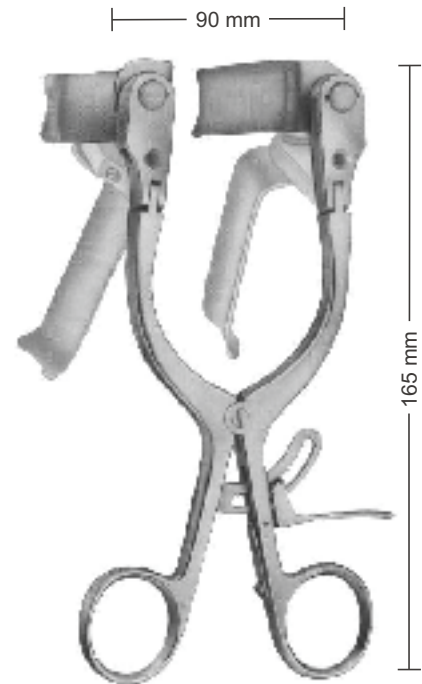

08-480 A
CASPAR
Counter retractor, adjustable,
consisting of: 5 blades.



08-481 40 x 23 mm
08-482 45 x 23 mm
08-483 50 x 23 mm
08-484 55 x 23 mm
08-485 60 x 23 mm
Medial blades

08-486 40 x 23 mm
08-487 45 x 23 mm
08-488 50 x 23 mm
08-489 55 x 23 mm
08-490 60 x 23 mm
Lateral blades

08-491 45 x 23 mm
08-492 50 x 23 mm
08-493 55 x 23 mm
08-494 60 x 23 mm
08-495 65 x 23 mm
Blunt blades

08-496 50 x 25 mm
08-497 60 x 25 mm
Blunt blades,
for harvesting of the
fusion graft from the
iliac crest

08-498 40 x 25 mm
08-499 45 x 25 mm
08-500 50 x 25 mm
08-501 55 x 25 mm
08-502 60 x 25 mm
Medial Titan blades
semi transparent to x-ray

08-503 40 x 25 mm
08-504 45 x 25 mm
08-505 50 x 25 mm
08-506 55 x 25 mm
08-507 60 x 25 mm
Lateral Titan blades
semi transparent to x-ray

Lamina Spreaders

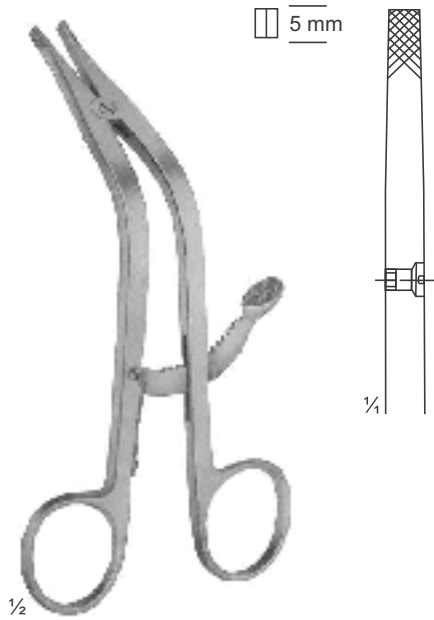

08-508
CLOWARD
155 mm

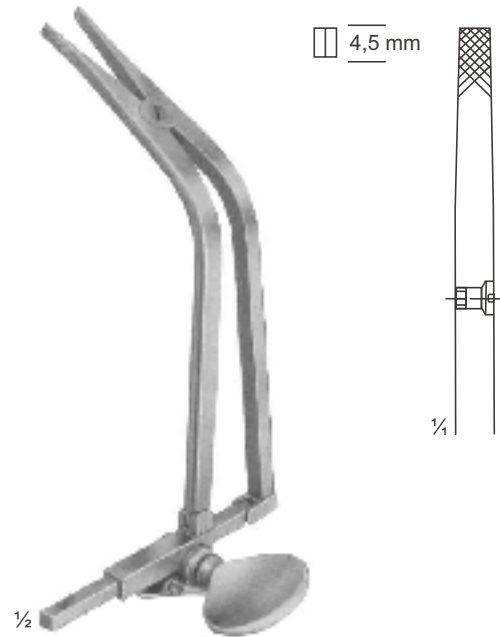

08-509
CLOWARD
135 mm

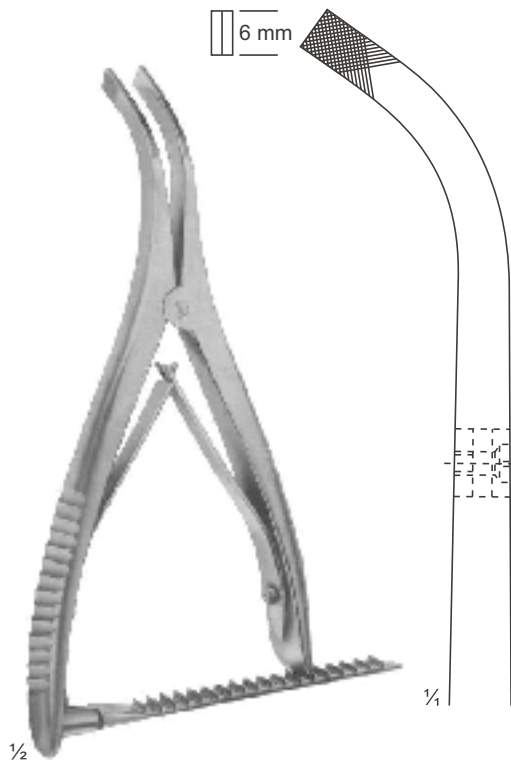

08-510
INGE
170 mm

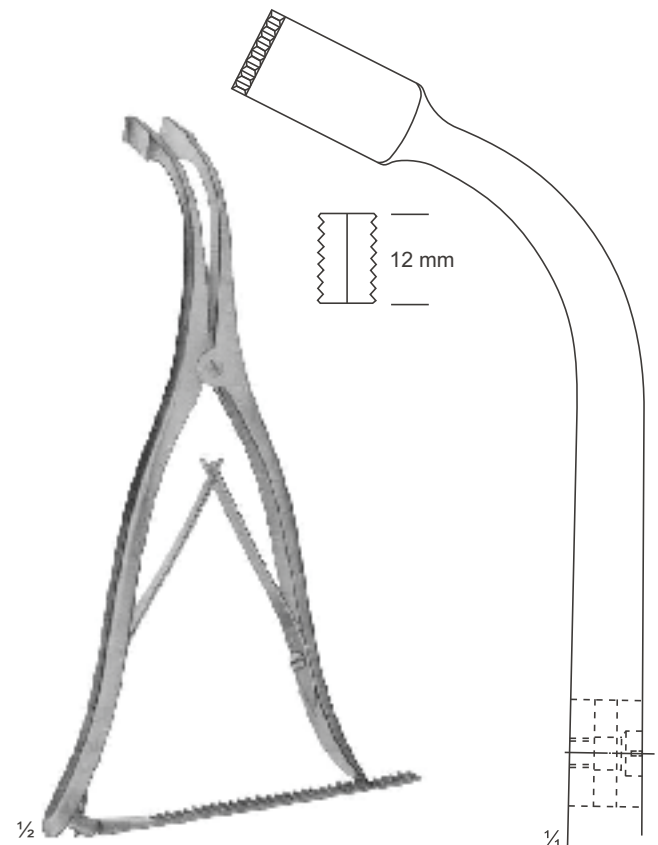

08-511
INGE
275 mm

Abdominal Retractors

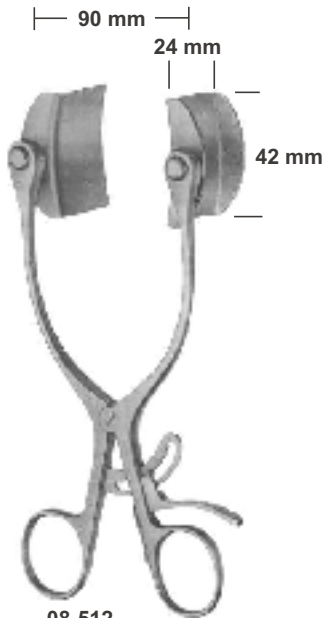

08-512
BABY-COLLIN
with 2 pair of blades

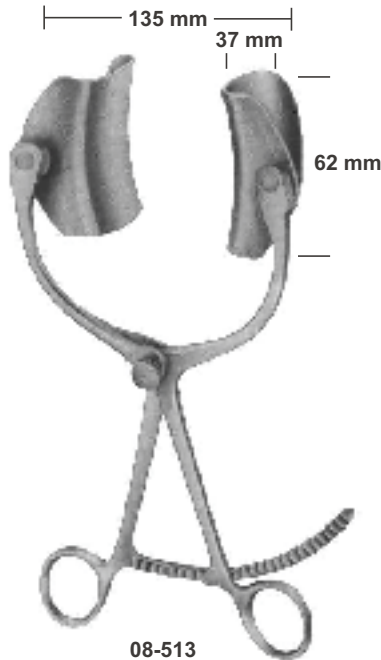

08-513
COLLIN
complete



08-514 Spreader only
08-515 Lateral blade
08-516 Canter blade

08-514 - 518
COLLIN
complete



08-519 - 520
RICARD
complete

Spreader only **08-519** **08-520**
Lateral blade 58x80mm 72x84mm
Canter blade 54x70mm 72x90mm



08-521 - 523
HOLZBACH
Complete

08-521 Spreader only
08-522 Lateral blade 59x80mm
08-523 Canter blade 74x82mm

Abdominal Baldes

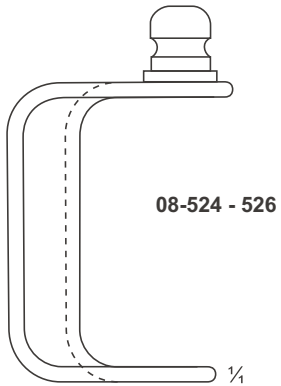

Lateral blades only
08-524 37x62 mm
08-525 37x80 mm
08-526 37x98 mm

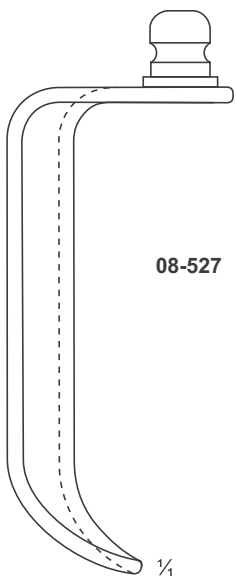

08-527 61x80 mm

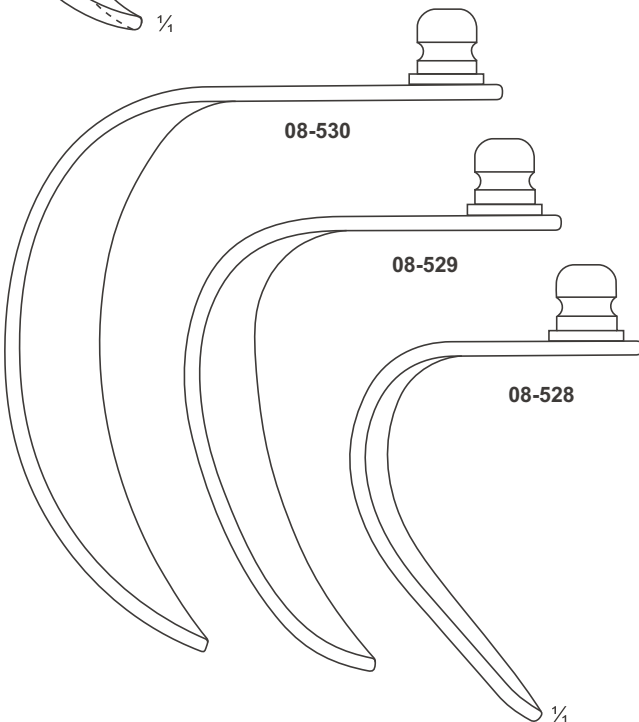

08-528 48x59 mm
08-529 58x80 mm
08-530 72x84 mm

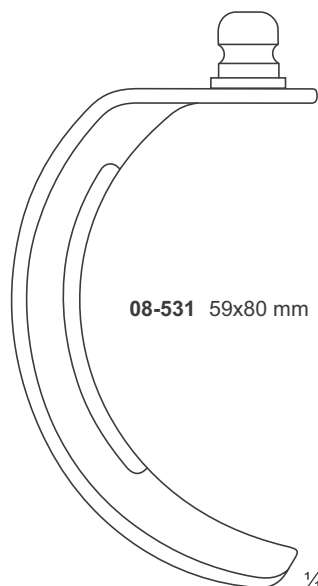
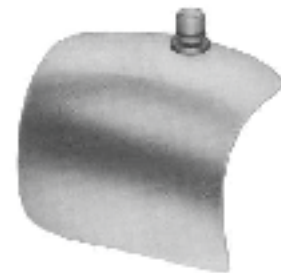

Abdominal Retractors

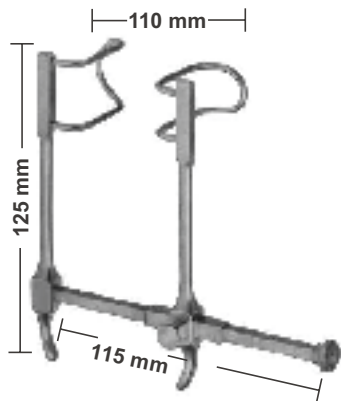

08-532
GOSSET
Blades:38 mm deep

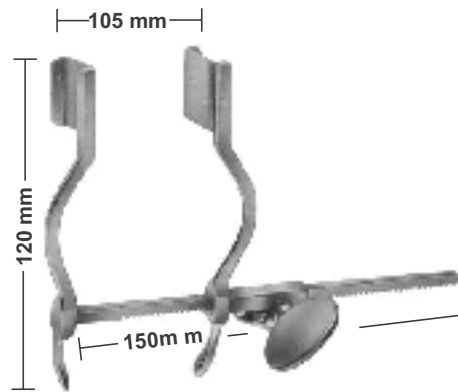

08-533
HERTZLER
Blades 20 X 25 mm

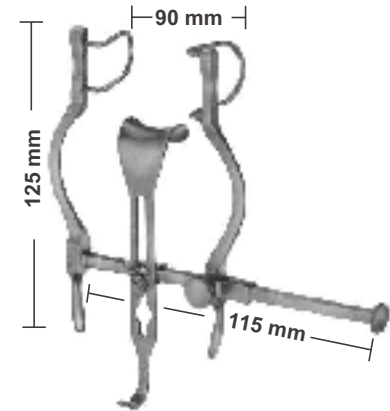

08-534
BALFOUR-BABY
Lateral blades 27 mm deep
Center blade 21x24 mm

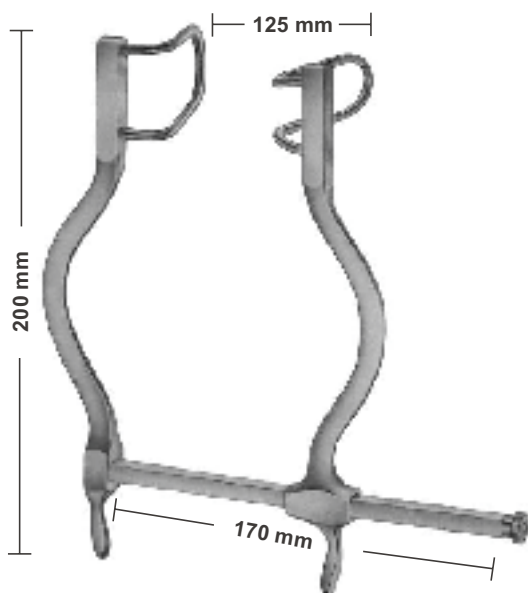

08-535
GOSSET
Blades:55mm deep

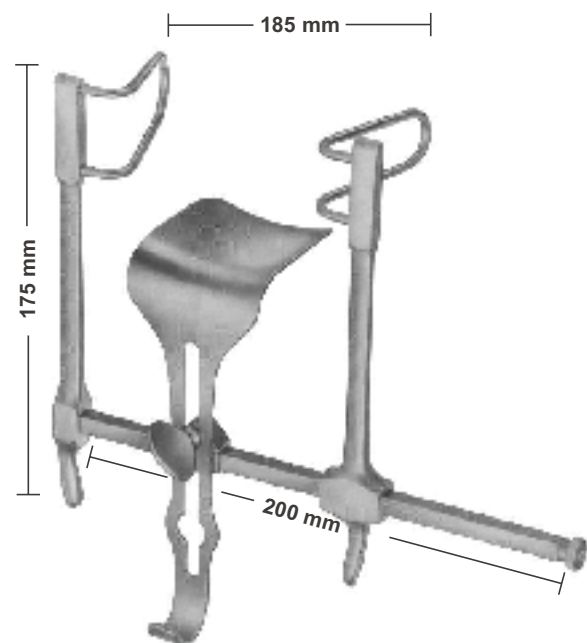

08-536
GOSSET
Lateral blades 58 mm deep
Center blade 59 x 57 mm

Abdominal Retractors

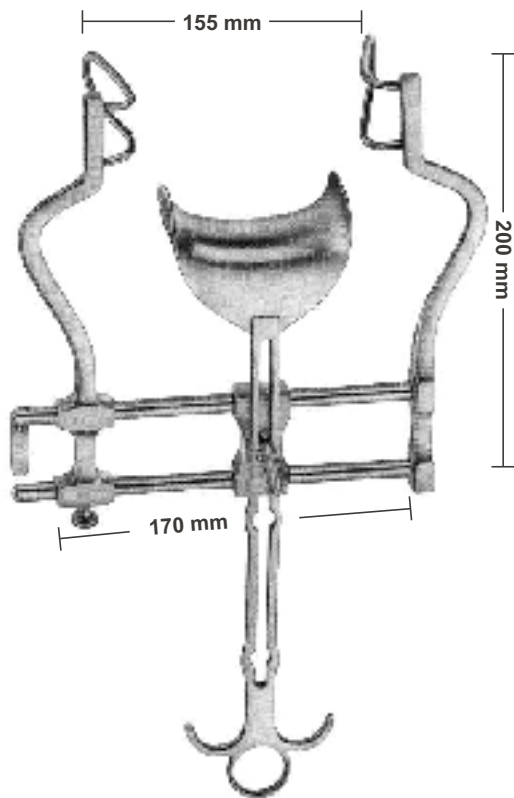

08-537
BALFOUR
Lateral blades 60 mm deep
Center blade 47 x 80 mm

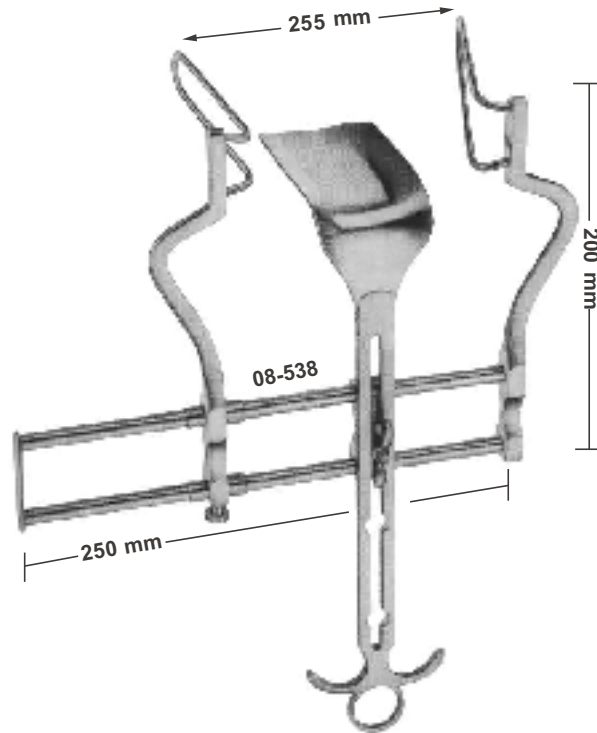

08-538
BALFOUR
Lateral blades 105 mm deep
Center blade 107x 59 mm



08-539
Center blade only
54x80 mm

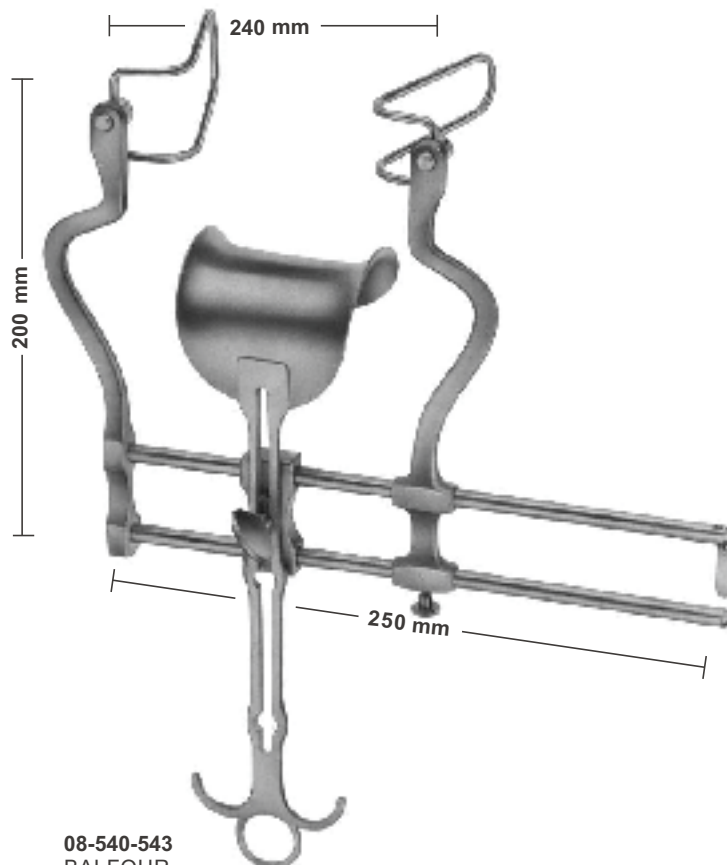

08-540-543
BALFOUR
Spreader only
Lateral blades 50 mm 08-540 60 mm 08-541 75 mm 08-542 90 mm 08-543
Center blade 47 x 80 mm 62x76 mm 80x80 mm 80x80 mm



Lateral blades
08-544 50 mm deep
08-545 60 mm deep
08-546 75 mm deep
08-547 90 mm deep
Sales Unit of blades: PR = pair

Abdominal Retractors

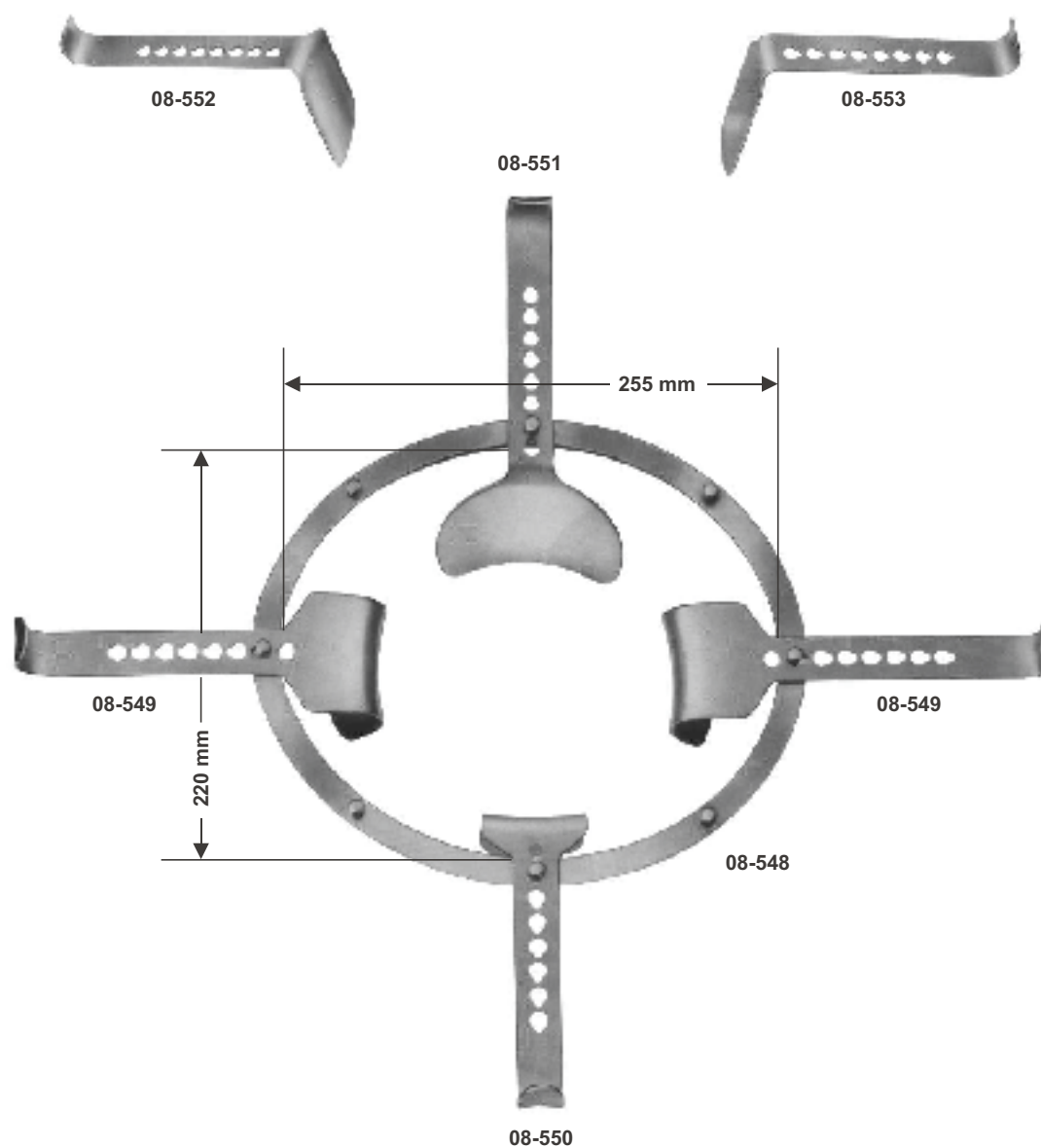

08-548 - 08-553

SEMM

consisting of:

- 08-548** 1 frame 225 x 220 mm
- 08-549** 2 blades 46 x 64 mm
- 08-550** 1 blade 53 x 54 mm
(for bladder)
- 08-551** 1 blade 82 x 97 mm
(for intestine)
- 08-552** 1 blade 98 x 51 mm
(for intestine)
- 08-553** 1 blade, narrow
107 x 36 mm

Abdominal Retractors

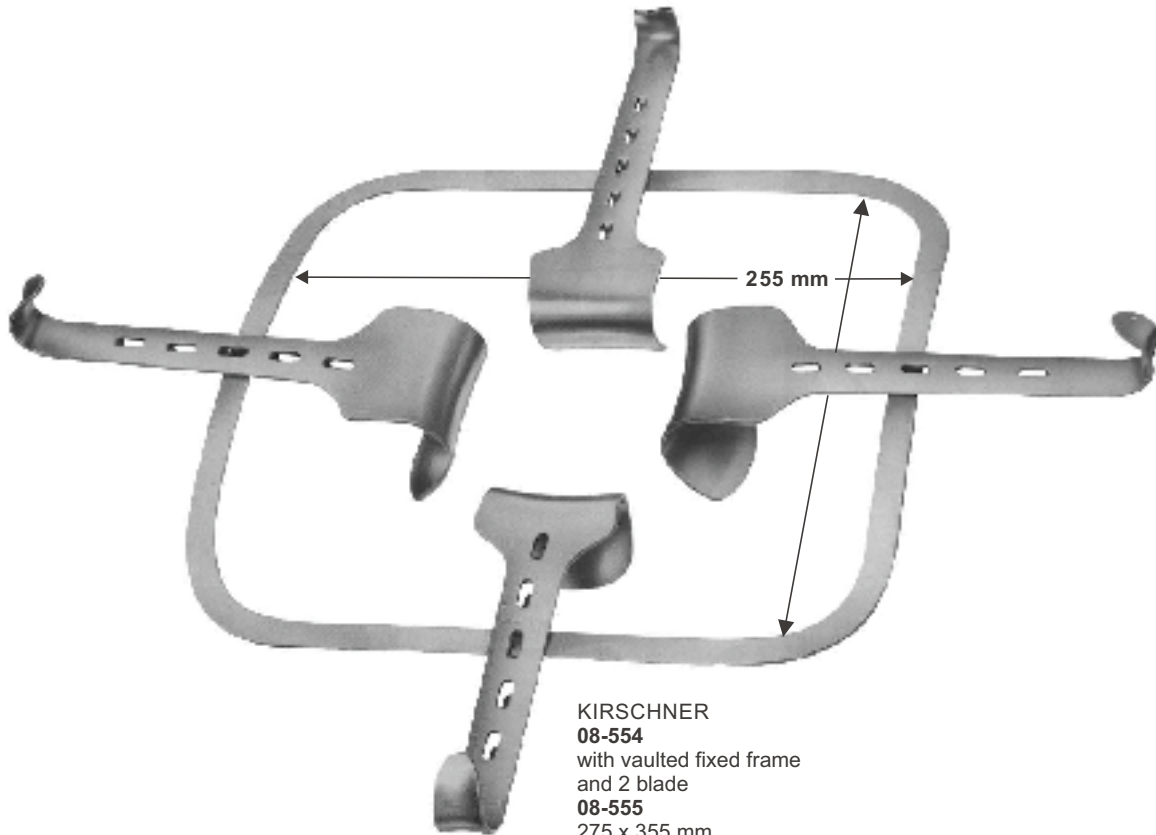

KIRSCHNER
08-554
 with vaulted fixed frame
 and 2 blade
08-555
 275 x 355 mm
 Frame only, over-sized
08-556
 295 x 275 mm
 Frame only



08-557
 KIRSCHNER
 64 x 80 mm



08-558
 KIRSCHNER-BALFOUR
 80x 82 mm



08-559 - 561
 KIRSCHNER
08-559 90x 69mm
08-560 92x 95mm
08-561 78x 58mm



08-562 - 564
 KIRSCHNER
08-562 108x42mm
08-563 91x 55mm
08-564 121x 55mm

Intestinal and Tissue Grasping Forceps

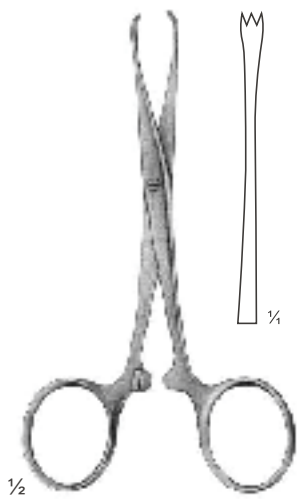

09-101
CHAPUT
2 X 3 teeth, sharp
125 mm,

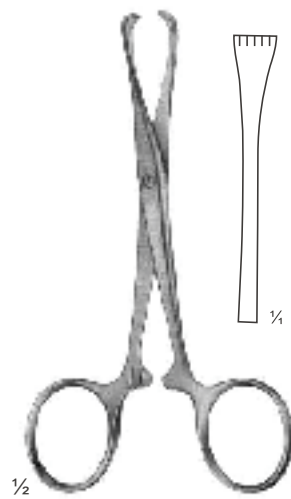

09-102
TUFFIER
5 X 6 teeth, sharp
125 mm,

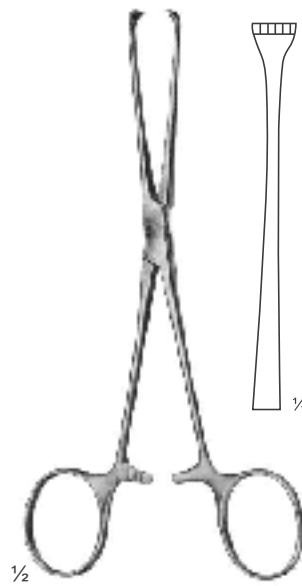

09-103
BOYS-ALLIS
5 X 6 teeth, sharp
155 mm,

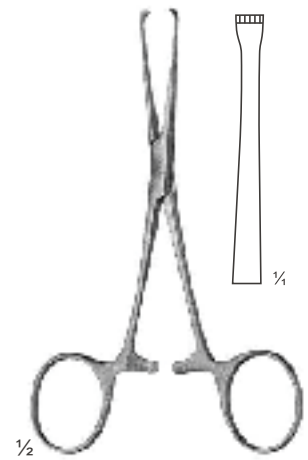

09-104
ALLIS
4 X 5 teeth
155 mm,

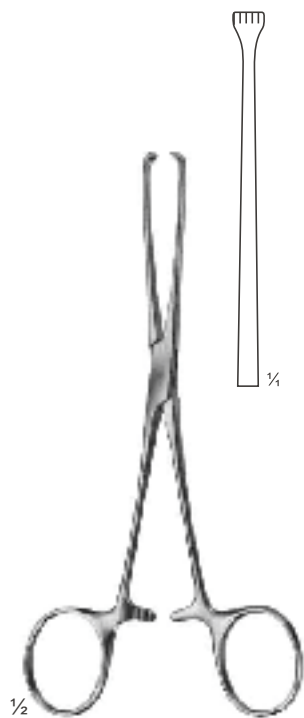

09-105
ALLIS
155 mm,
4 X 5 teeth

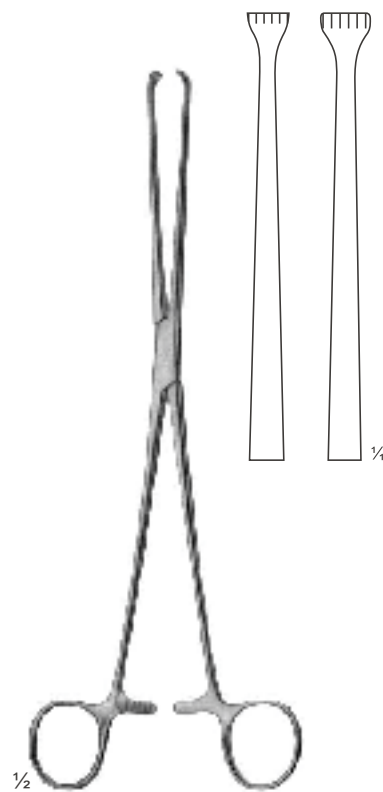

09-106
ALLIS
190 mm,
09-107
255 mm,
5 X 6 teeth

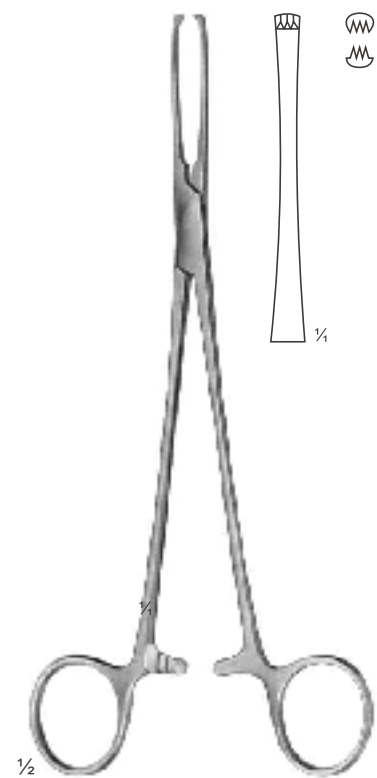

09-108
JUDD-ALLIS
3 X 4 teeth
195 mm,

Intestinal Grasping Forceps

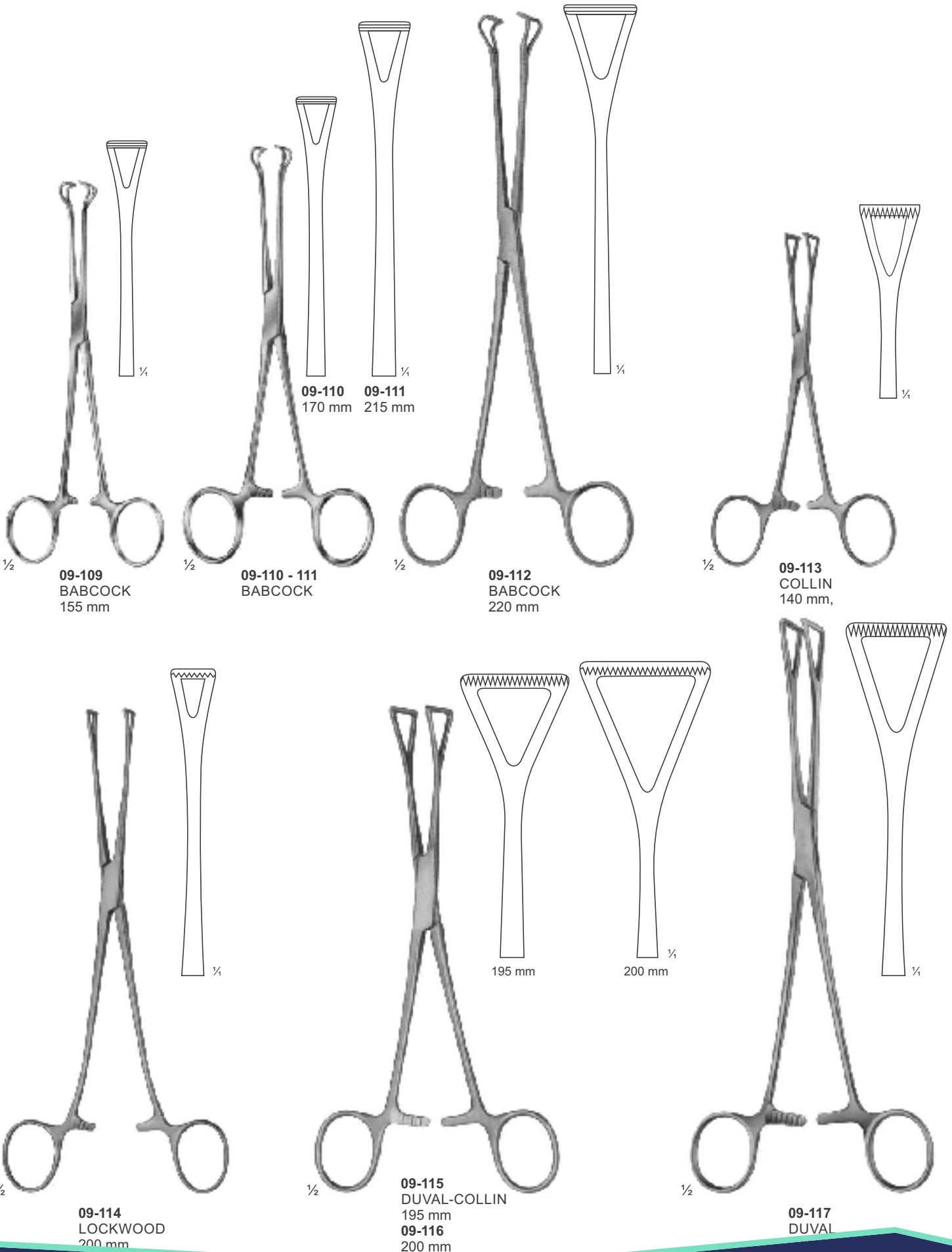

Organ - Tissue Grasping, Dissecting & Intestinal Forceps

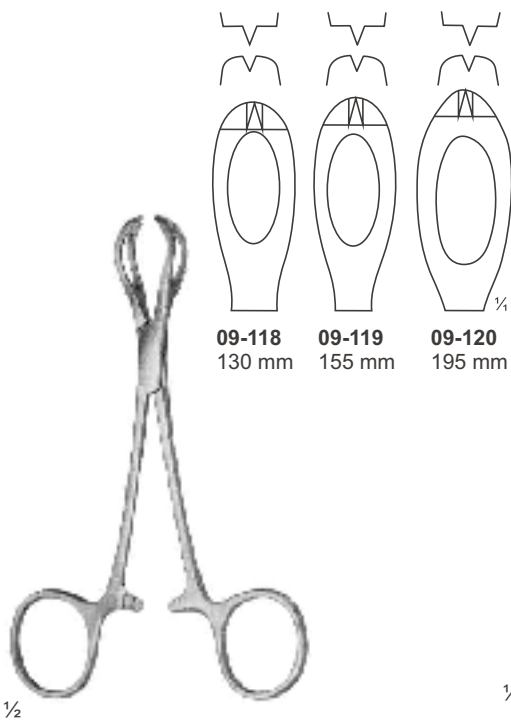

09-118-120
LANE

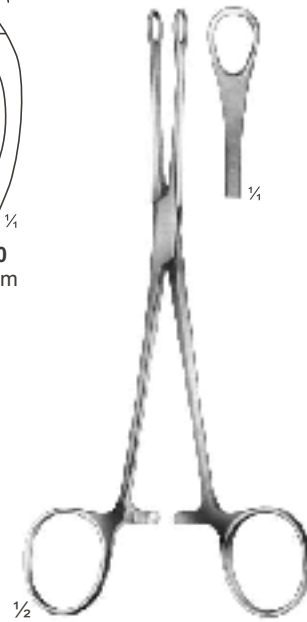

09-121
WILLIAMS
160 mm



09-122
DENIS
BROWNE
190 mm

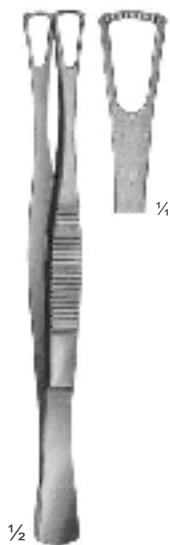

09-123
DUVAL
140 mm



09-124
WANGENSTEEN
150 mm
09-125
230 mm



09-126
WANGENSTEEN
150 mm
09-127
230 mm

Organ - Tissue Grasping, Dissecting & Intestinal Forceps

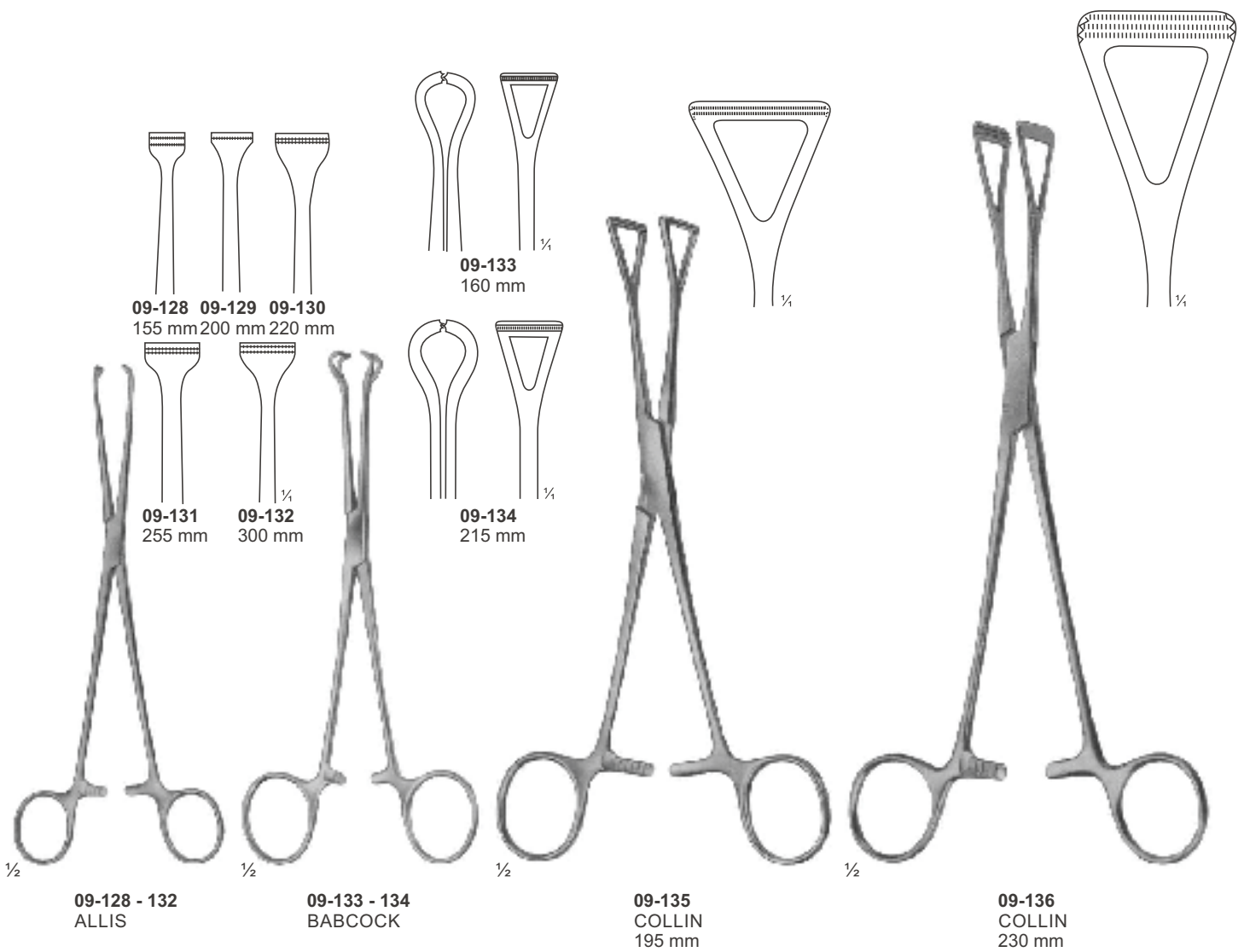

Ultra - Light - Forceps, Dissecting Forceps

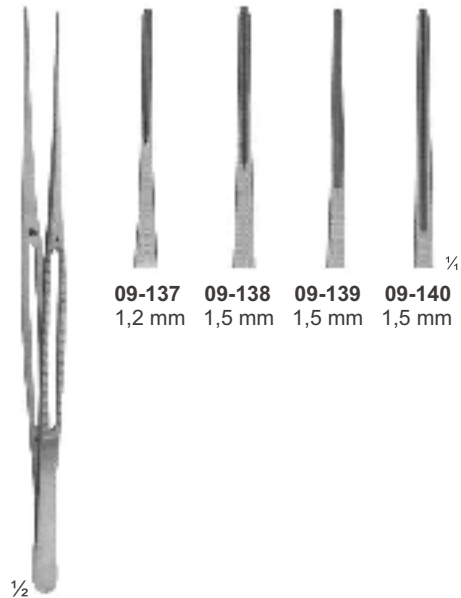

09-137 1,2 mm
09-138 1,5 mm
09-139 1,5 mm
09-140 1,5 mm

09-137 150 mm
09-138 200 mm
09-139 240 mm
09-140 300 mm

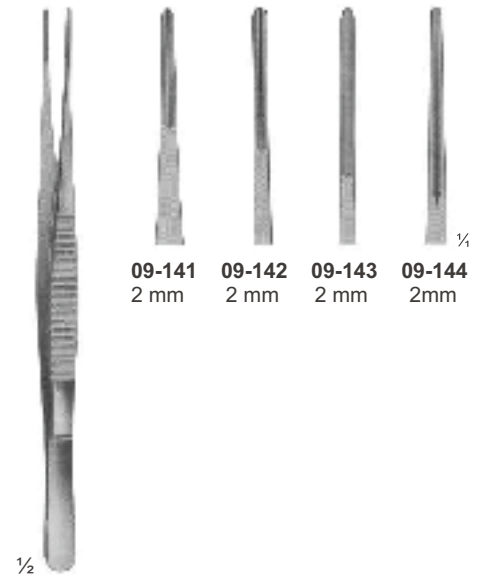

09-141 2 mm
09-142 2 mm
09-143 2 mm
09-144 2mm

DE BAKEY
09-141 150 mm
09-142 200 mm
09-143 240 mm
09-144 300 mm

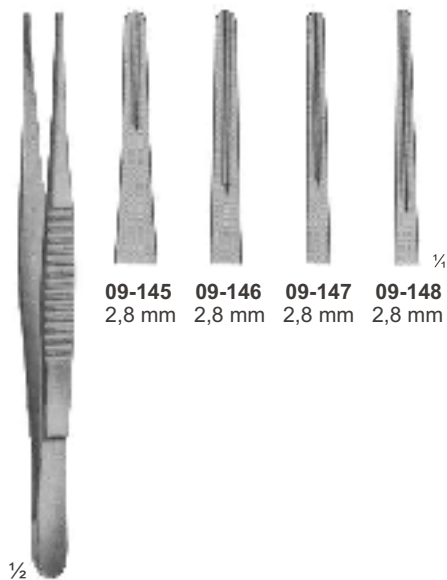

09-145 2,8 mm
09-146 2,8 mm
09-147 2,8 mm
09-148 2,8 mm

DE BAKEY
09-145 150 mm
09-146 200 mm
09-147 240 mm
09-148 300 mm

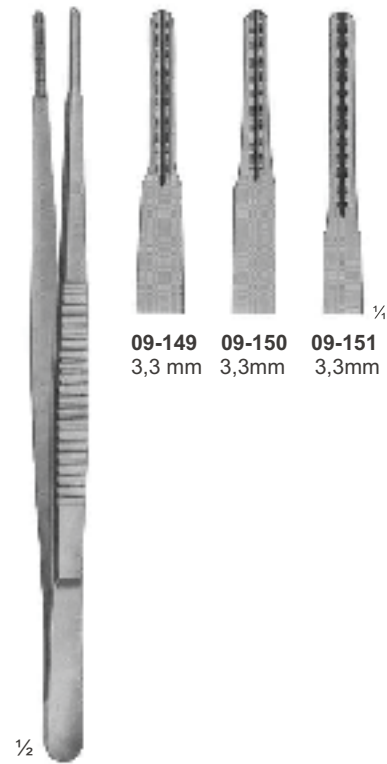

09-149 3,3 mm
09-150 3,3mm
09-151 3,3mm

DE BAKEY
09-149 200 mm
09-150 240 mm
09-151 300 mm

Intestinal Clamps for Children

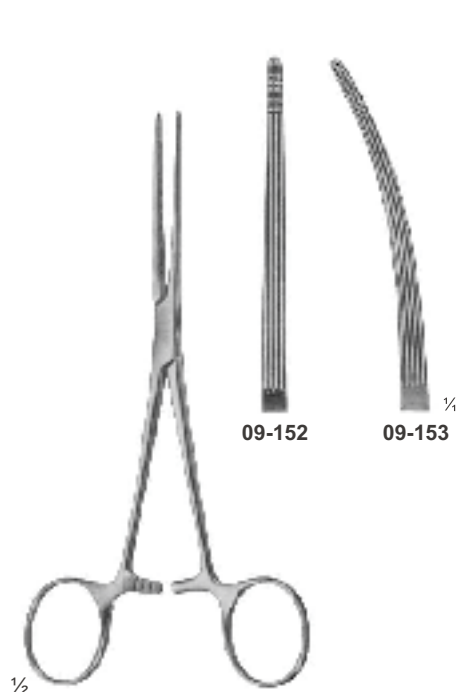

09-152 - 153
BAINBRIDGE
155 mm



09-154
ALLEN
155 mm

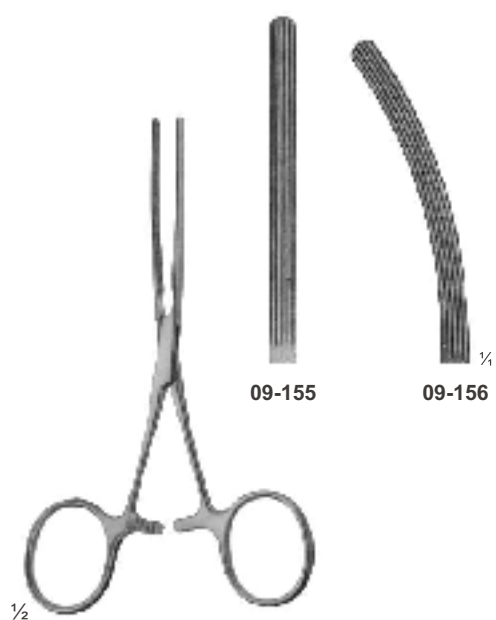

09-155 - 156
BABY-KOCHER
very elastic blades
130 mm

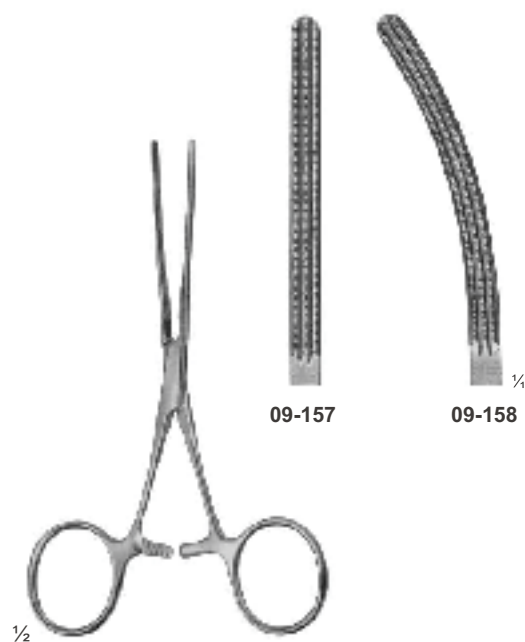

09-157 - 158
BABY-KOCHER
with elastic blades
130 mm

Intestinal Clamps, Soft Elastic

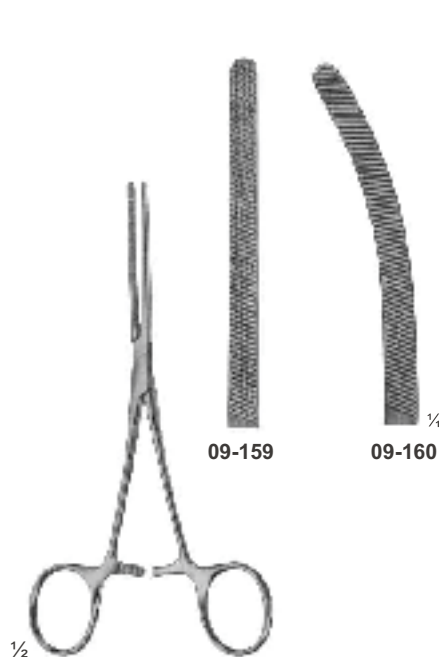

09-159 - 160
DOYEN
elastic
165 mm

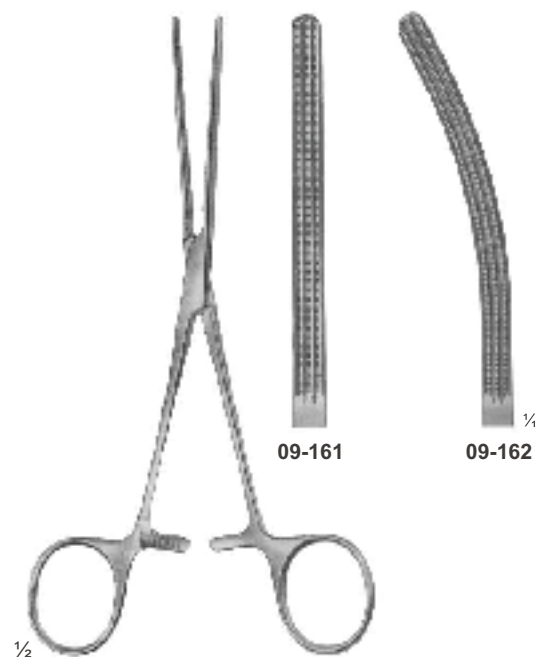

09-161 - 162
DOYEN
with elastic blades
170 mm

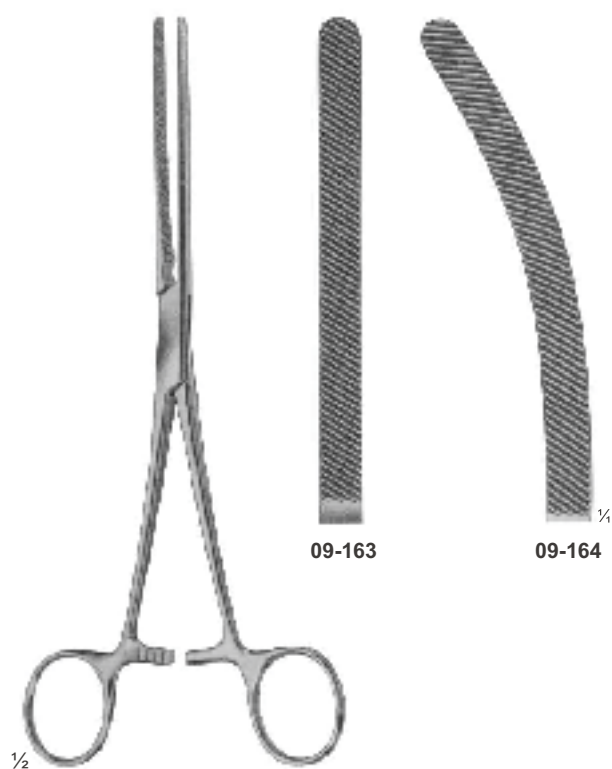

09-163 - 164
HARTMANN
with elastic blades
200 mm

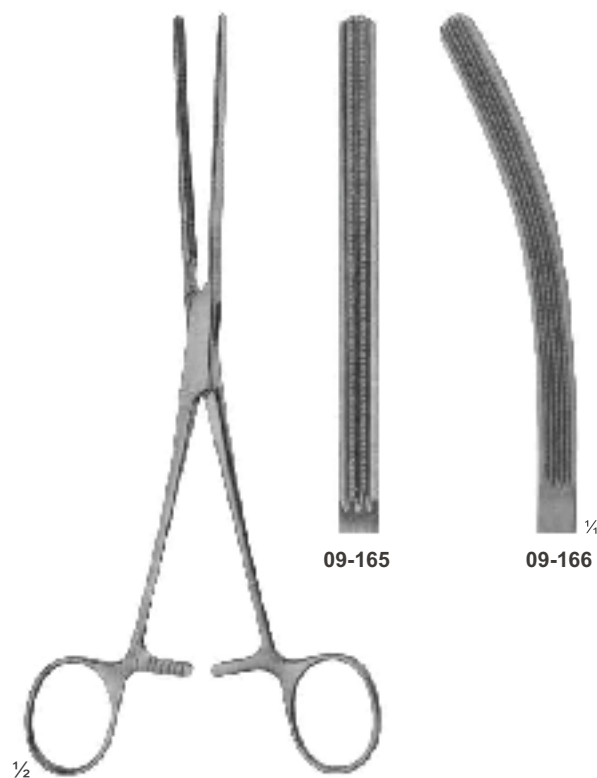

09-165 - 166
HARTMANN
with elastic blades
200 mm

Intestinal Clamps, Soft elastic

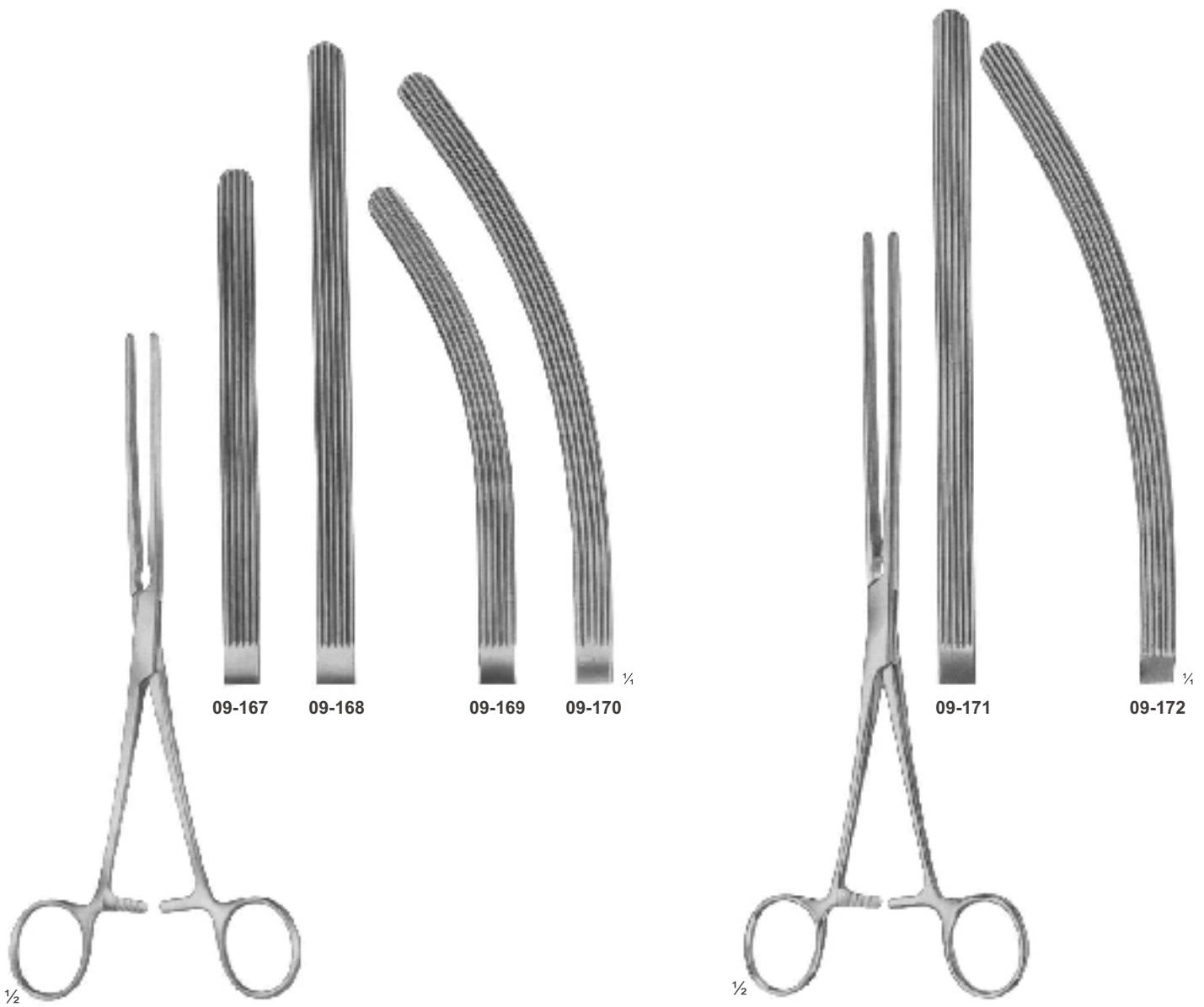

09-167 - 170
KOCHER
 with elastic blades
09-169 210 mm
09-170 230 mm

09-171 - 172
DOYEN
 with elastic blades
 210 mm

Intestinal Clamps, Soft elastic

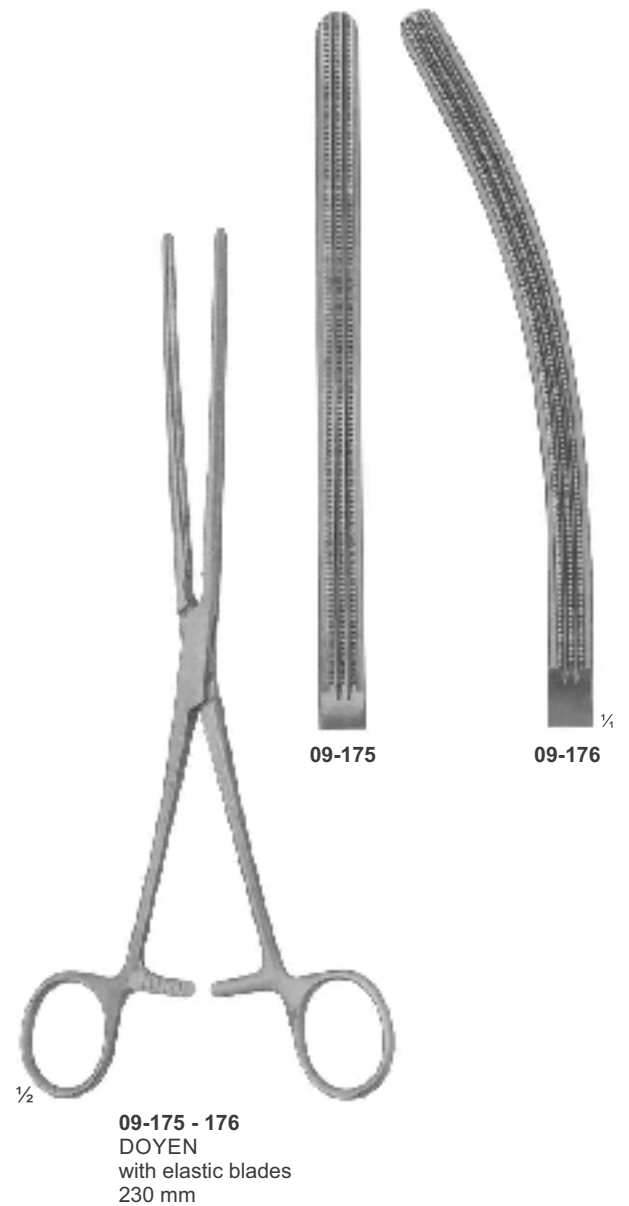
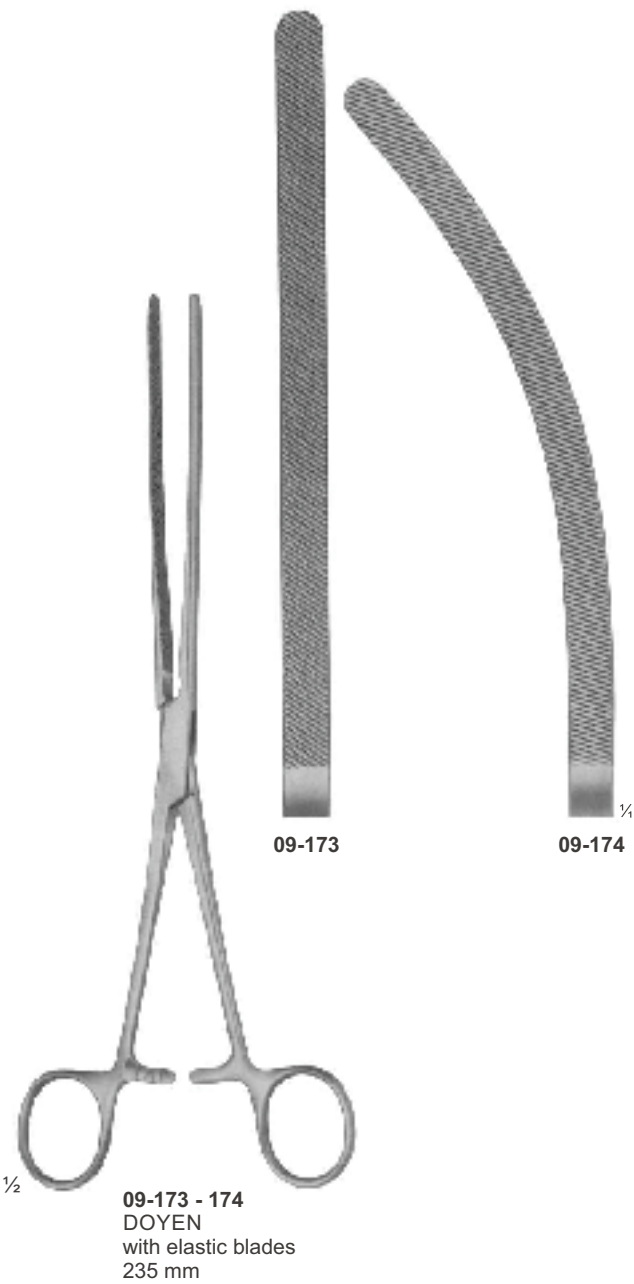

Intestinal Clamps, Soft elastic

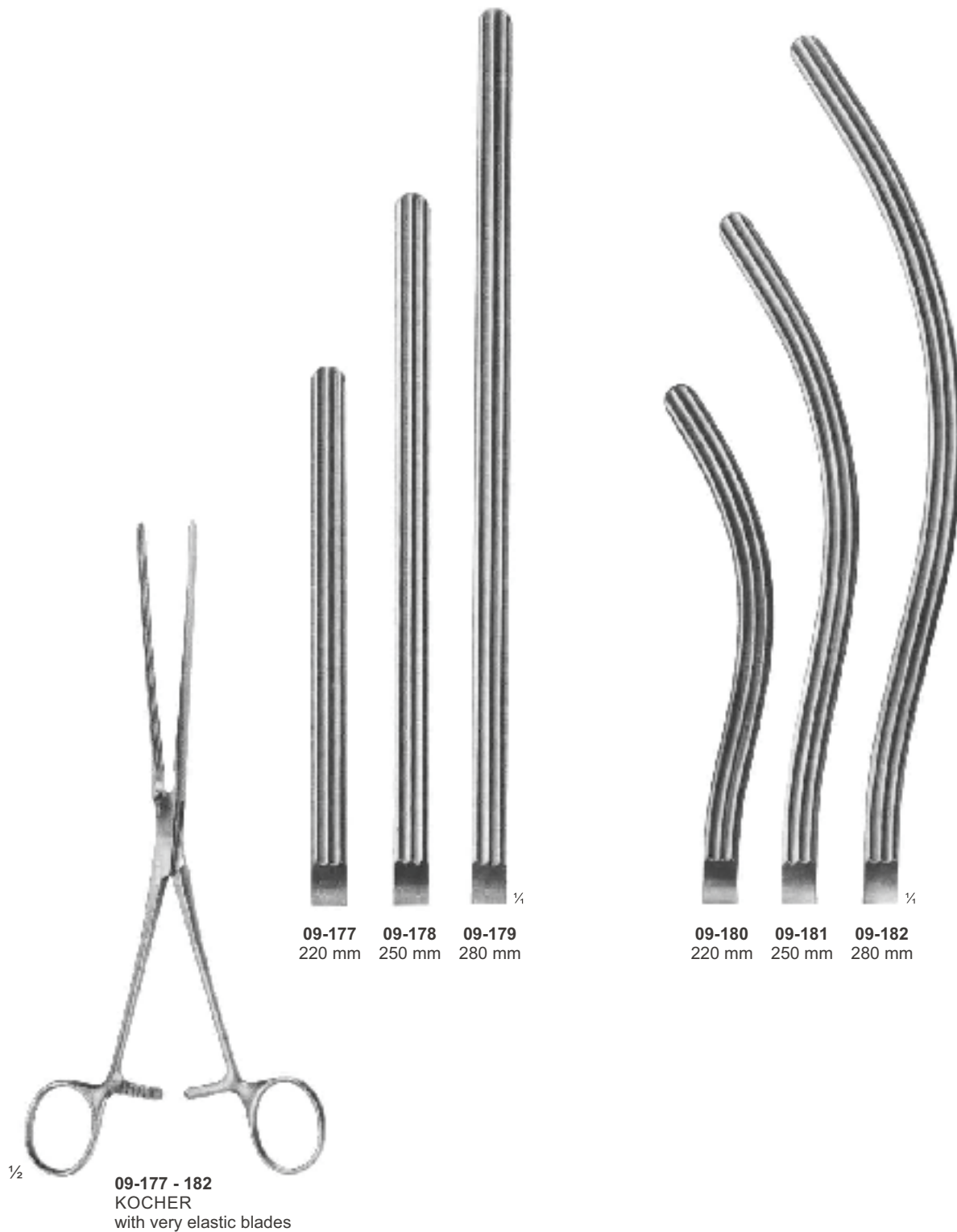

Intestinal Clamps, Soft elastic

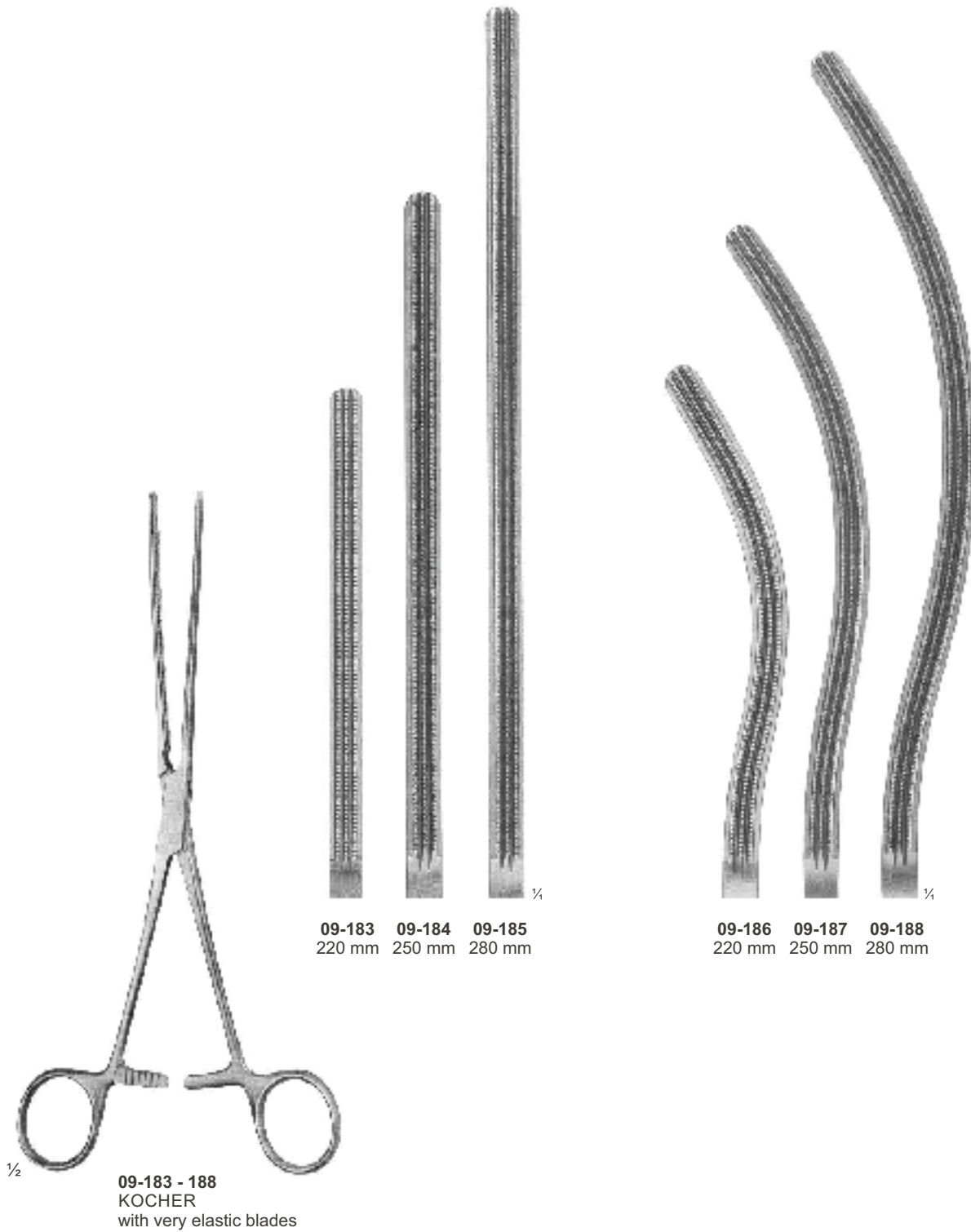

Intestinal Clamps

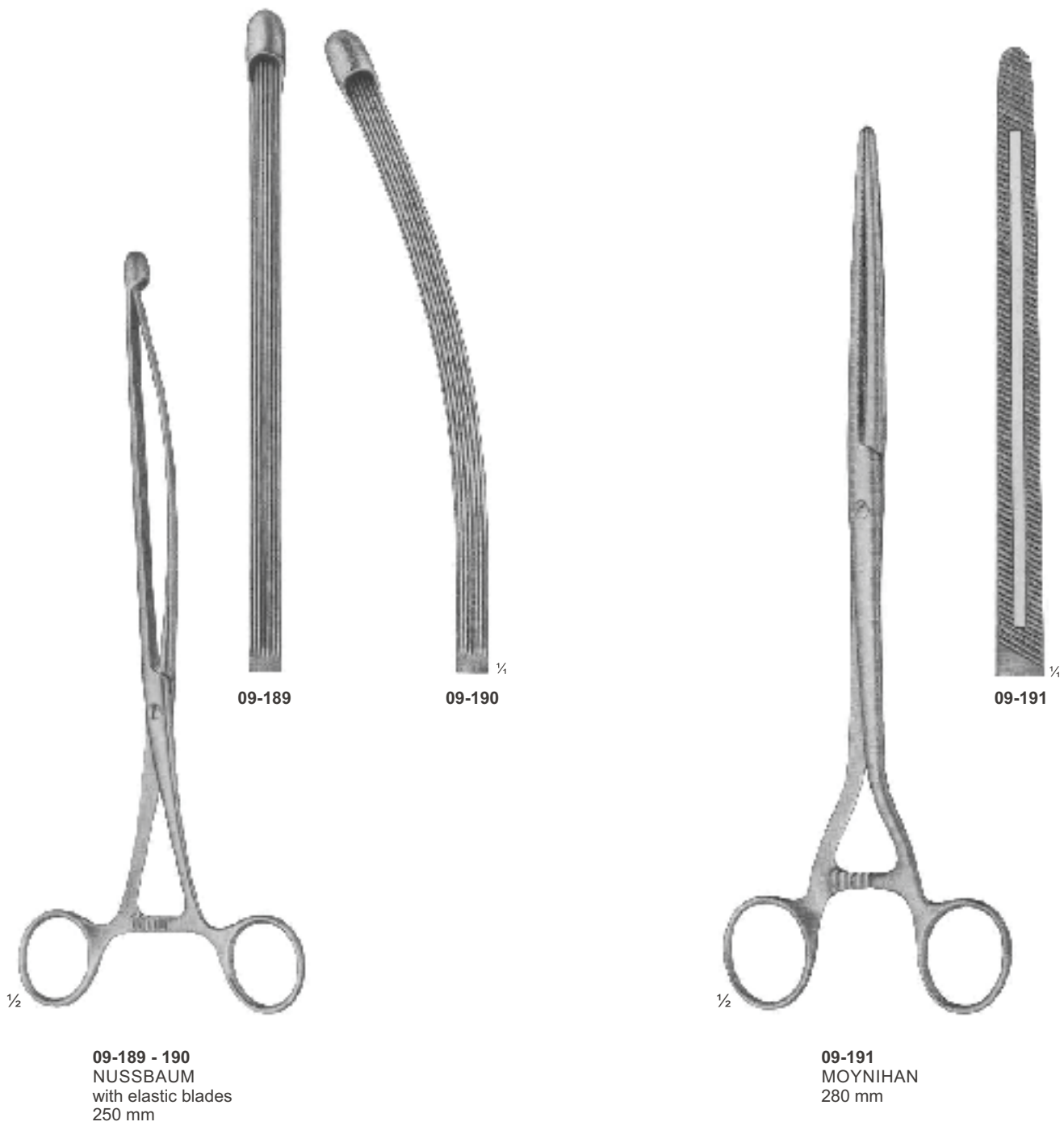

09-189 - 190
NUSSBAUM
 with elastic blades
 250 mm

09-191
MOYNIHAN
 280 mm

Intestinal Clamps

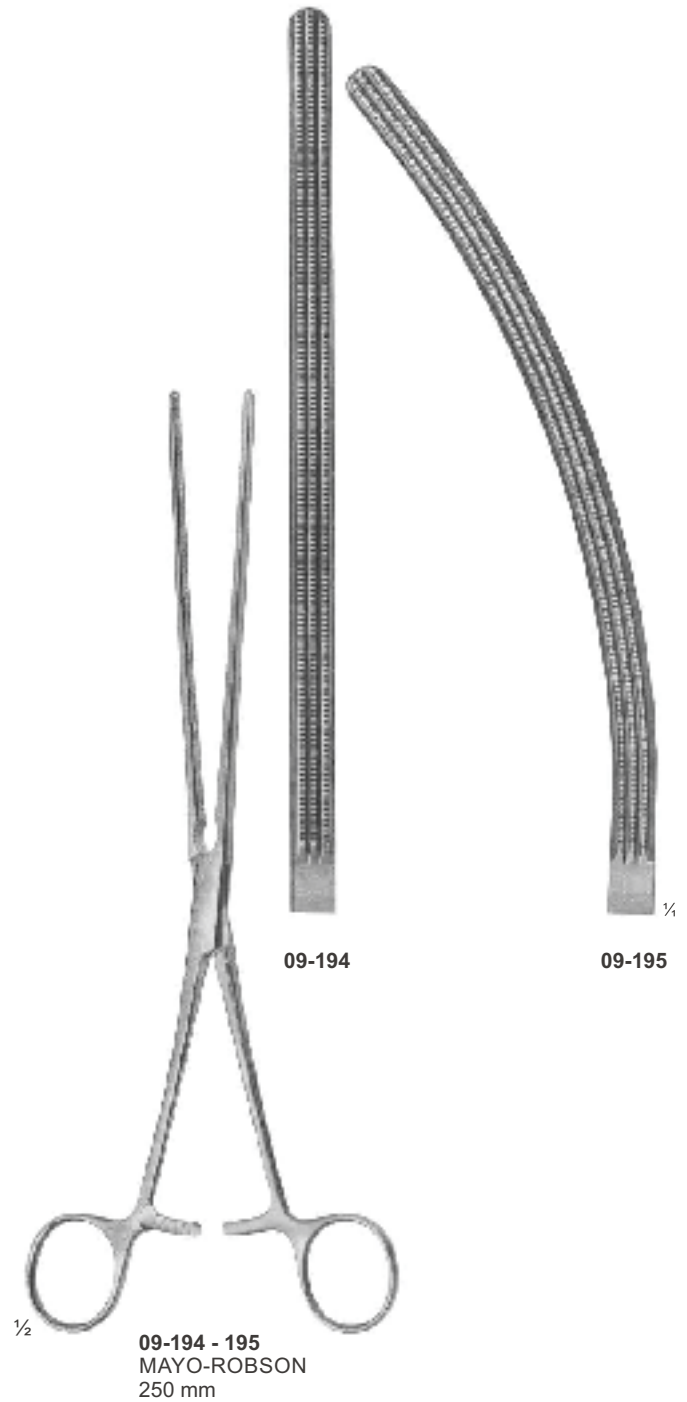
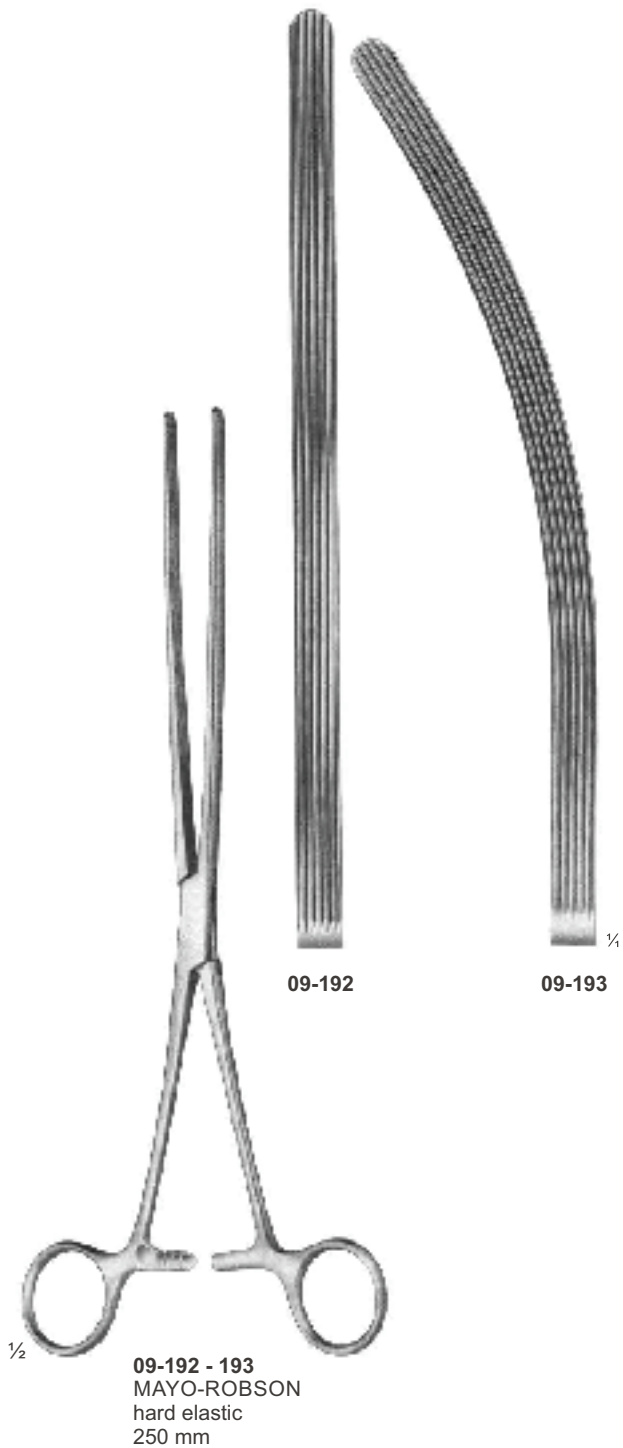

Gastro-Intestinal Forceps, twin



09-196
LANE
300 mm

09-197
LANE
300 mm

Stomach Clamps



09-198

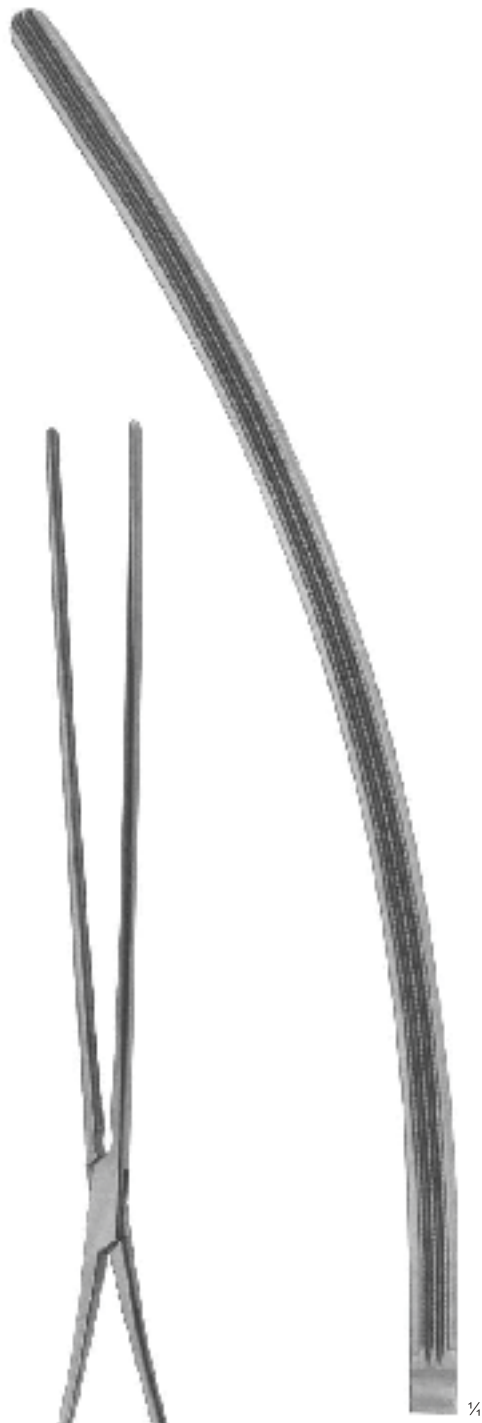

09-199

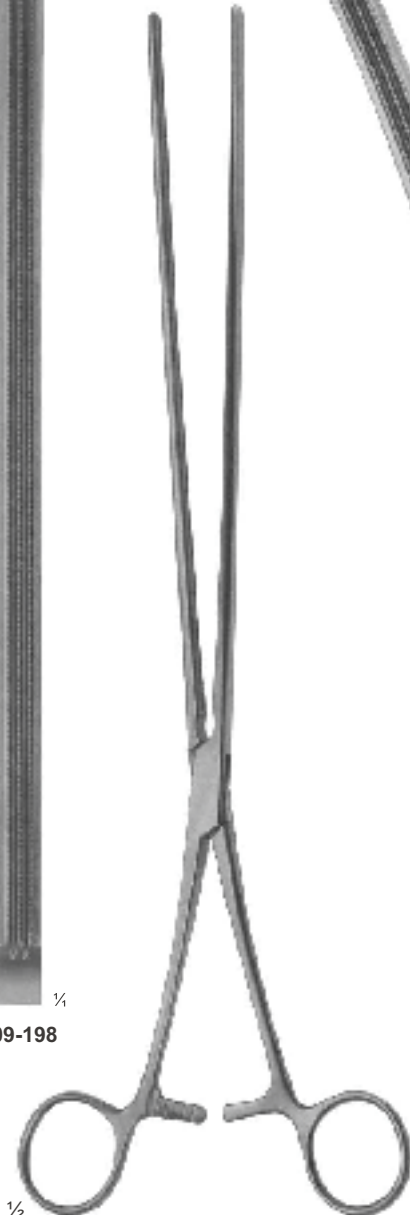

09-198 - 199
SCUDDER
330 mm



09-200
KLEINSCHMIDT
Spur crushers and
Appendectomy clamps
130 mm

Intestinal and Pylorus Clamps



09-201
PAYR
Intestinal clamp
light pattern,
for children
180 mm

09-202
PAYR
200 mm

09-203
PAYR
275 mm

09-204
PAYR
Pylorus clamp
315 mm

Anastomosis Forceps

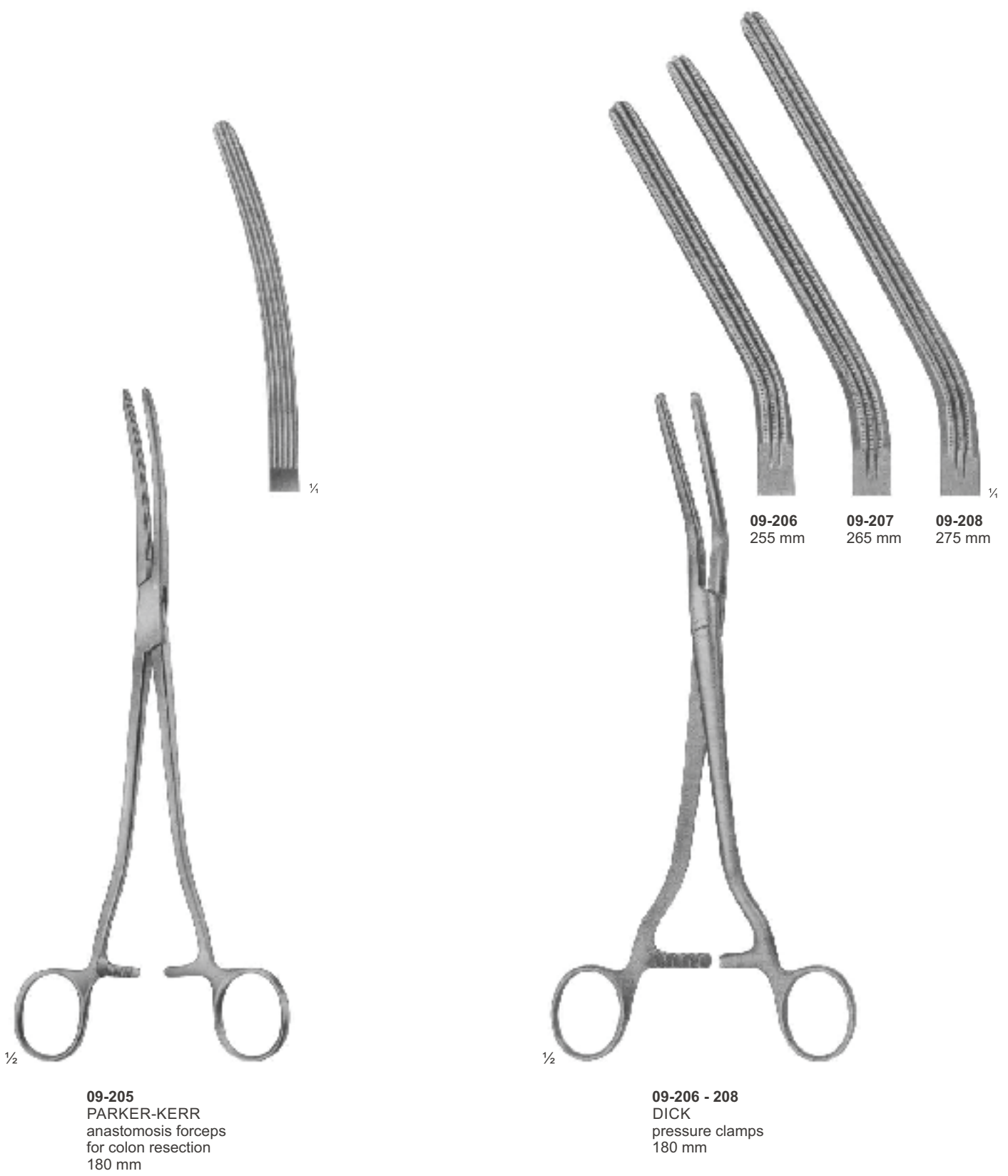

1/2

09-205
PARKER-KERR
anastomosis forceps
for colon resection
180 mm

09-206
255 mm

09-207
265 mm

09-208
275 mm

1/2

09-206 - 208
DICK
pressure clamps
180 mm

Sigmoid Anastomosis Forceps



Sigmoid Anastomosis Forceps

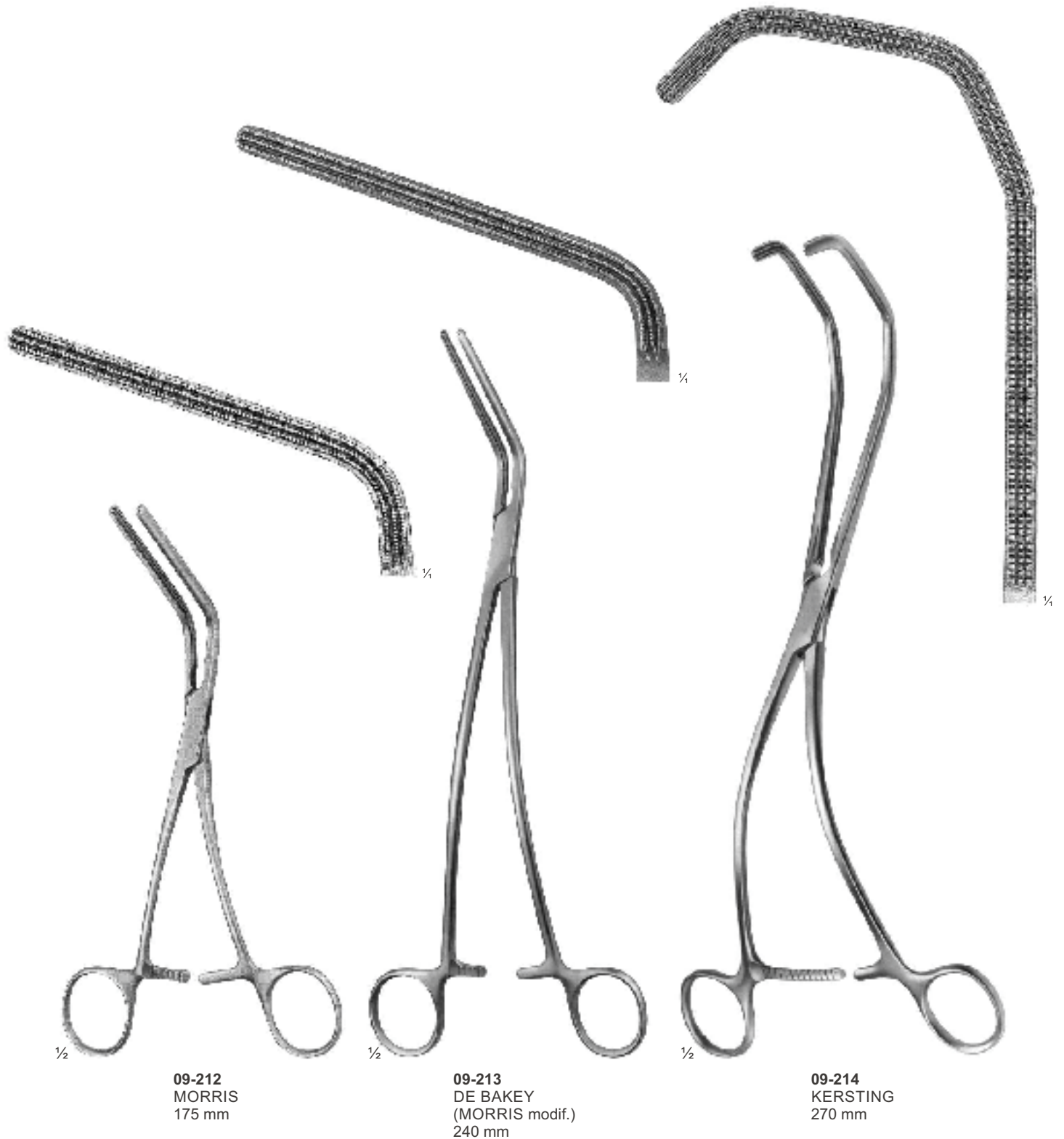

Rectal Specula

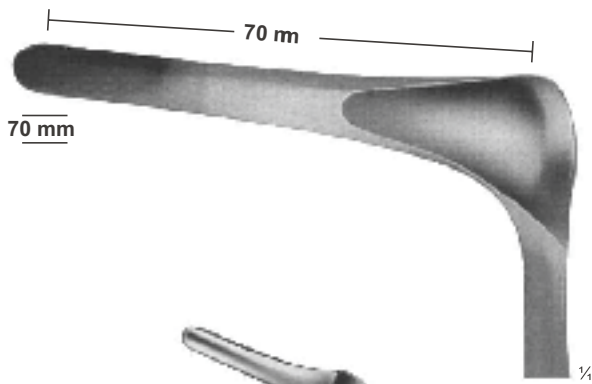

10-101
KILLIAN
for children
145 mm



10-102
SIMS
160 mm



10-103
SIMS
160 mm

Rectal Specula



10-104 - 107

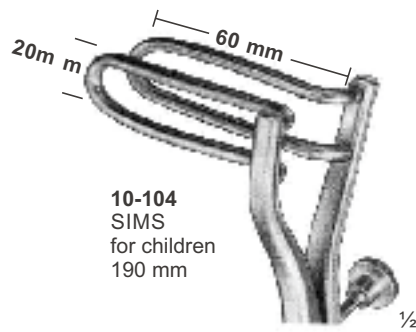

10-104
SIMS
for children
190 mm

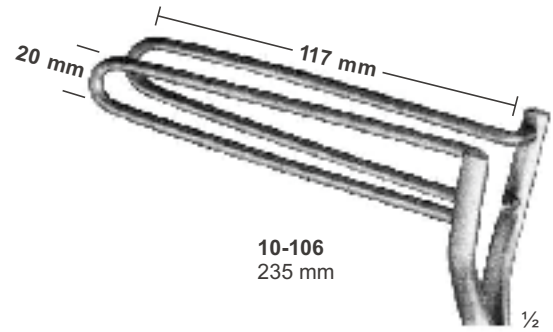

10-106
235 mm

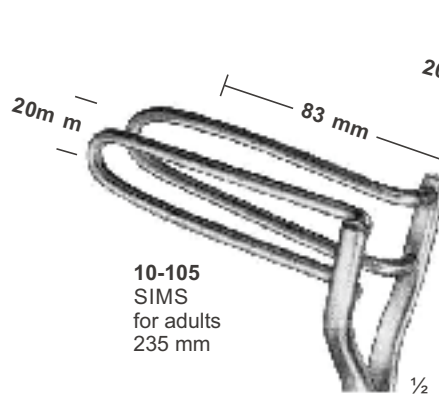

10-105
SIMS
for adults
235 mm

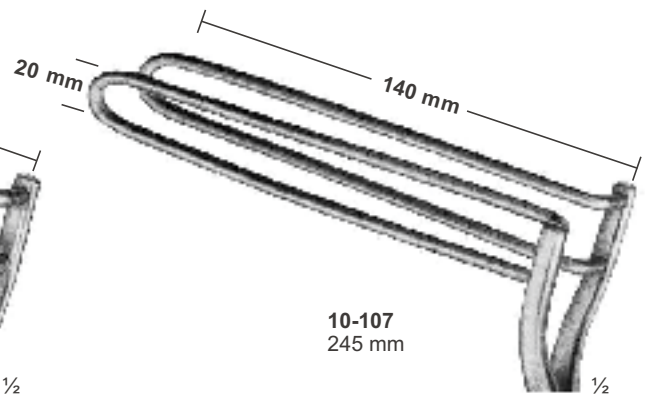

10-107
245 mm



10-108
PRATT
205 mm

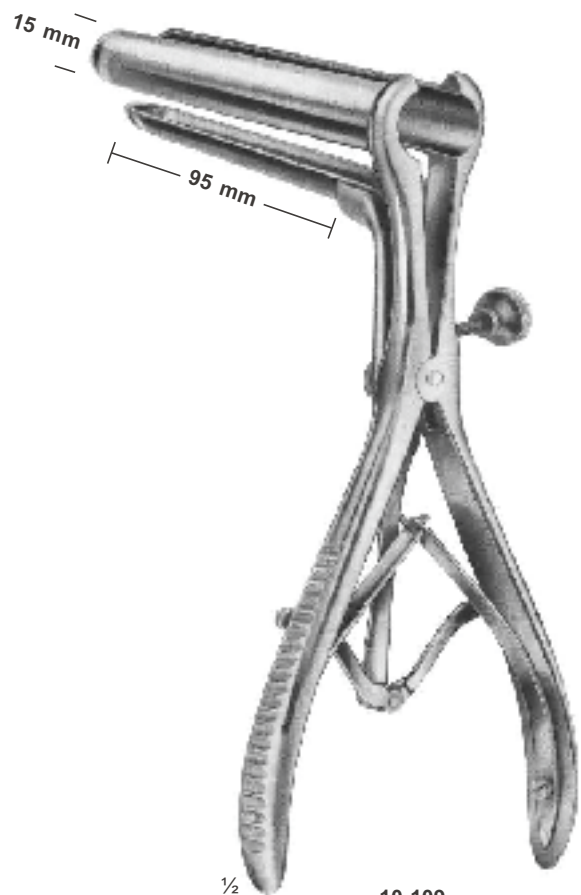

10-109
MATHIEU
215 mm

Anusscopes-Sphincteroscopes



10-110
IVES-FANSLER
Anuscope
145 mm



10-111
KELLY
Sphincteroscope
160 mm

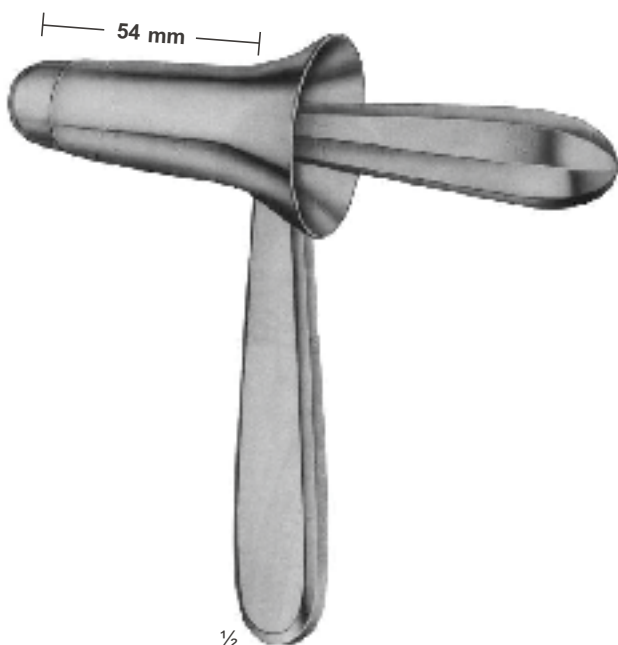

10-112
KELLY
Sphincteroscope
160 mm

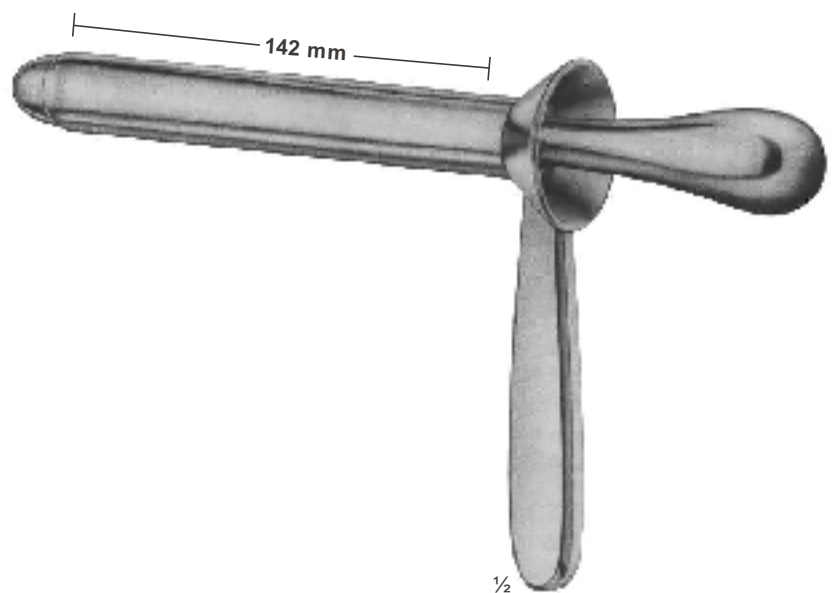

10-113
KELLY
Proctoscope
160 mm

Biopsy forceps for rectum

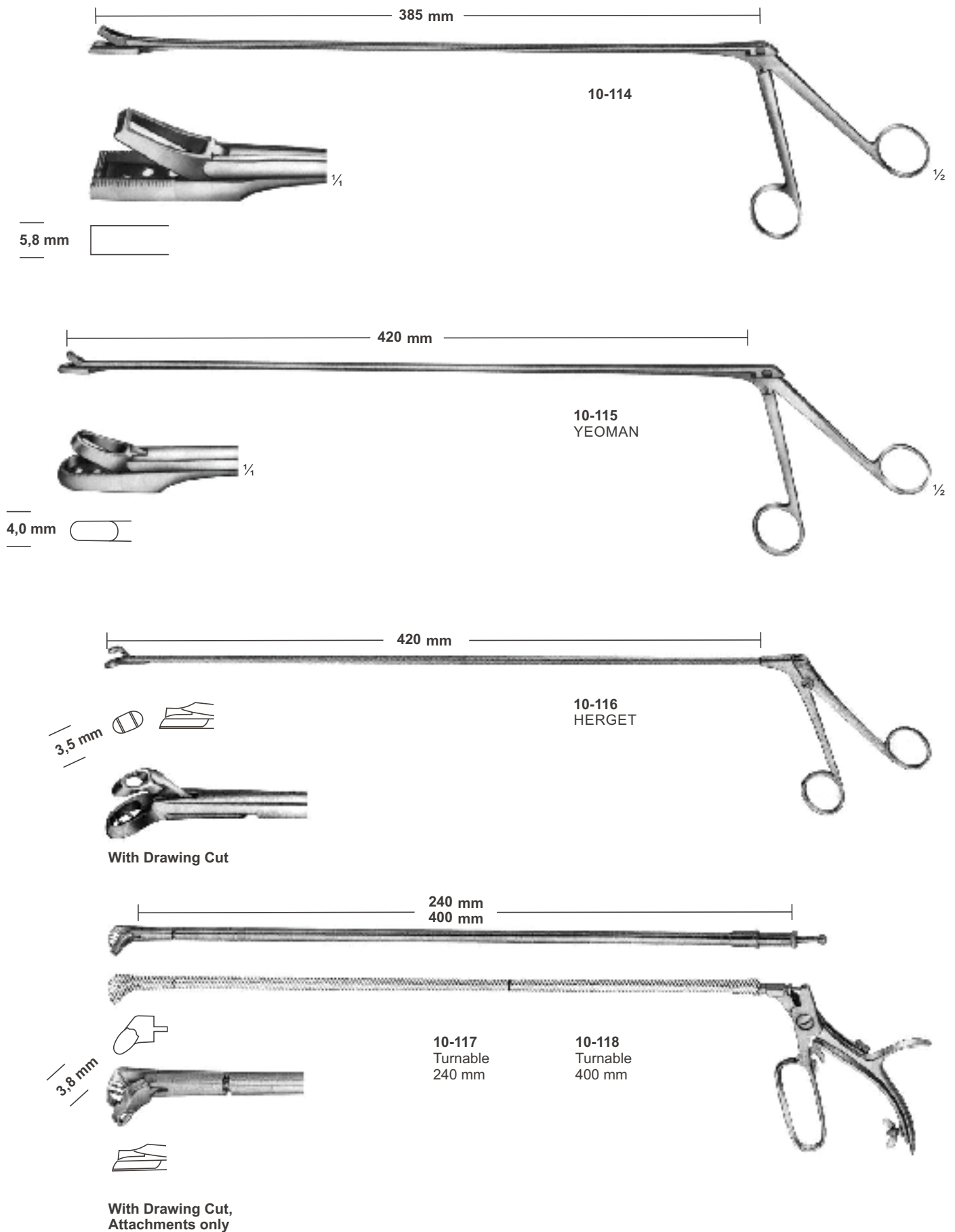

Biopsy Forceps & Swab Holders

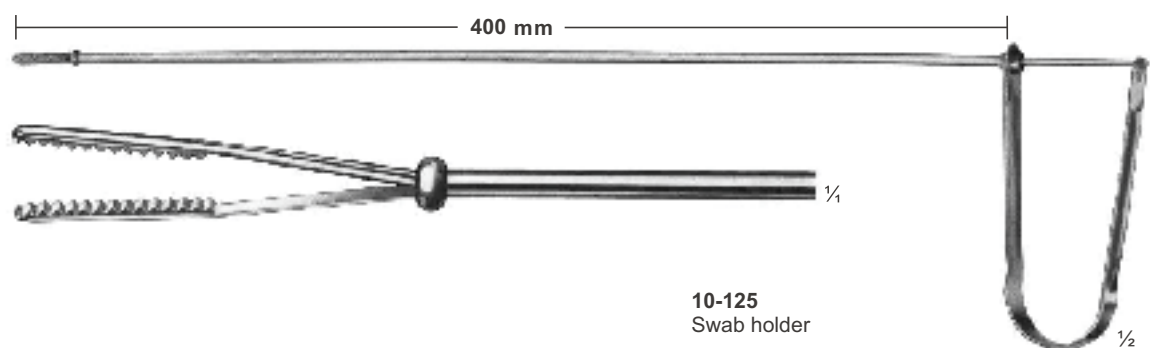
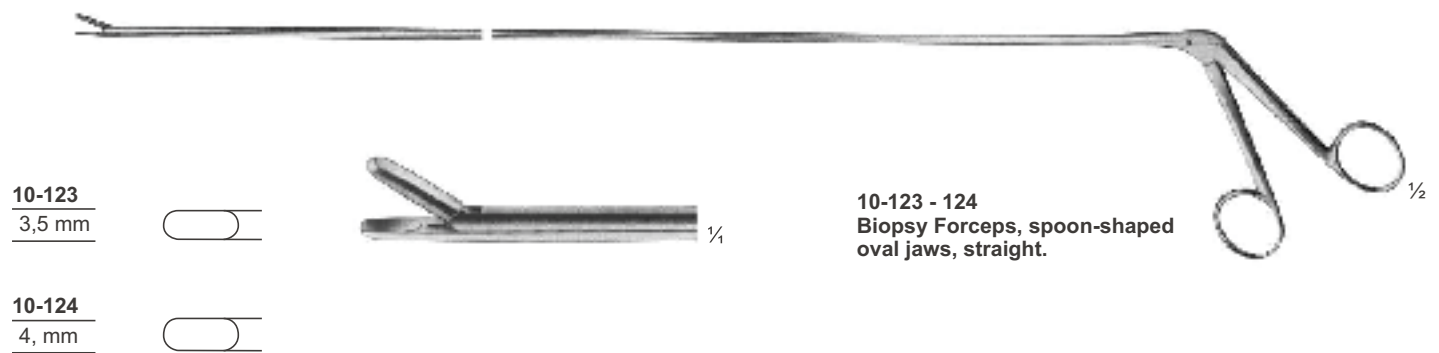
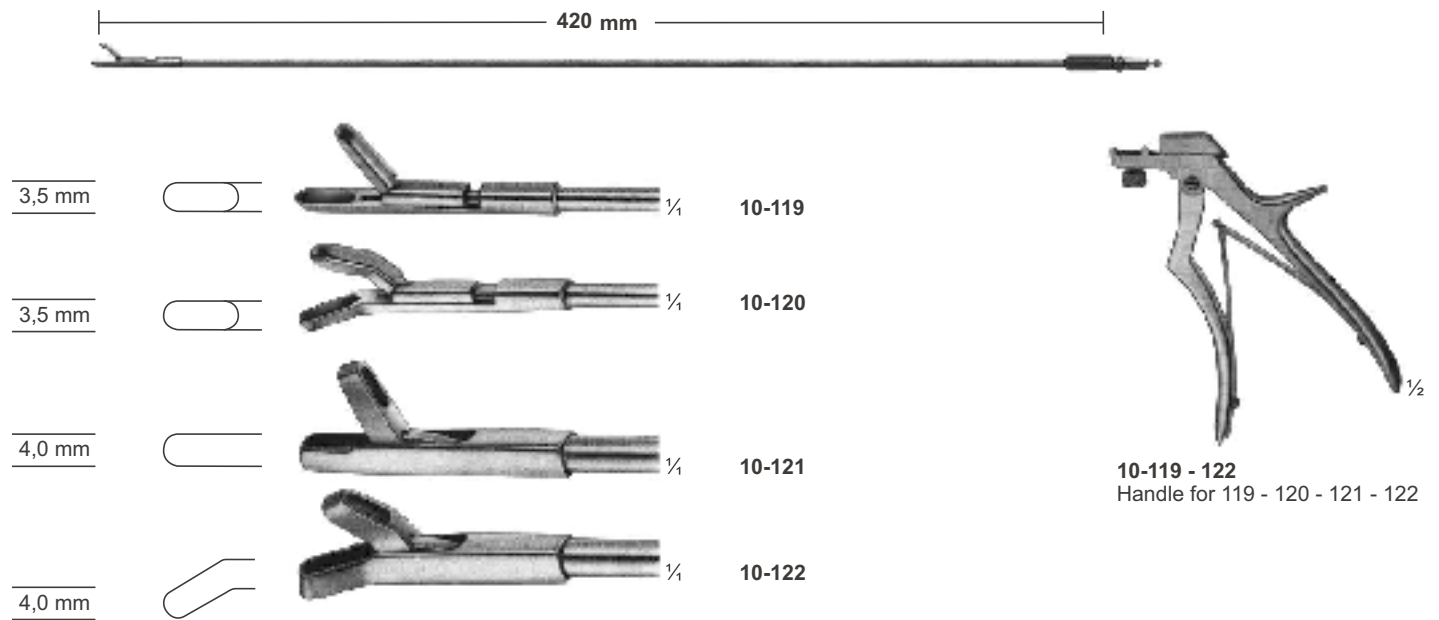

Haemorrhoidal Forceps

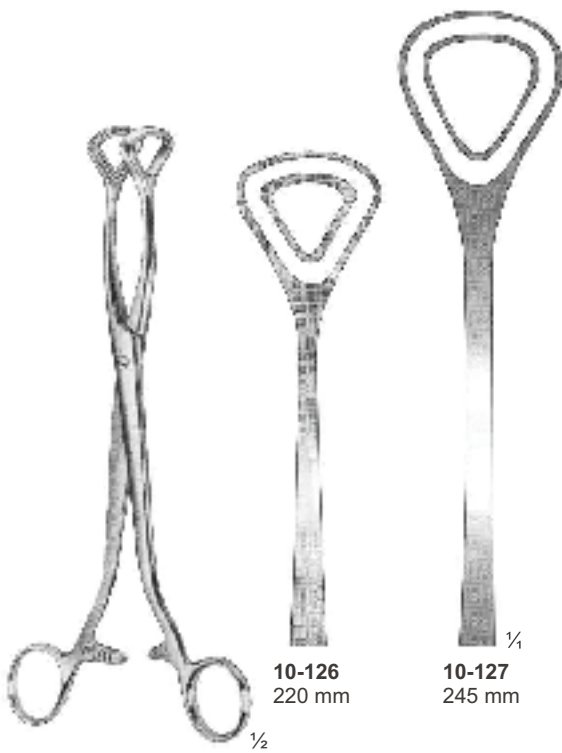

10-126 - 127
LUER

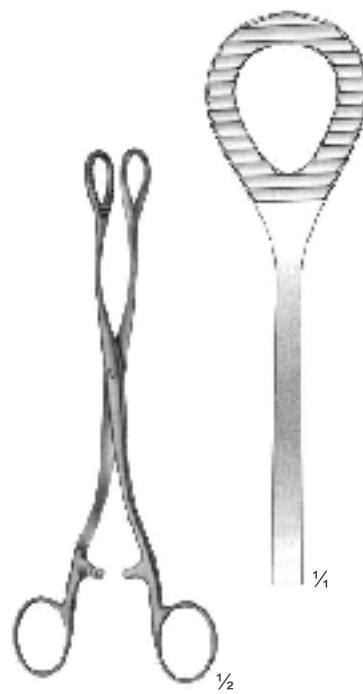

10-128
HEYWOOD-SMITH
200 mm



10-129
HEYWOOD-SMITH
modif
200 mm

Haemorrhoidal Forceps

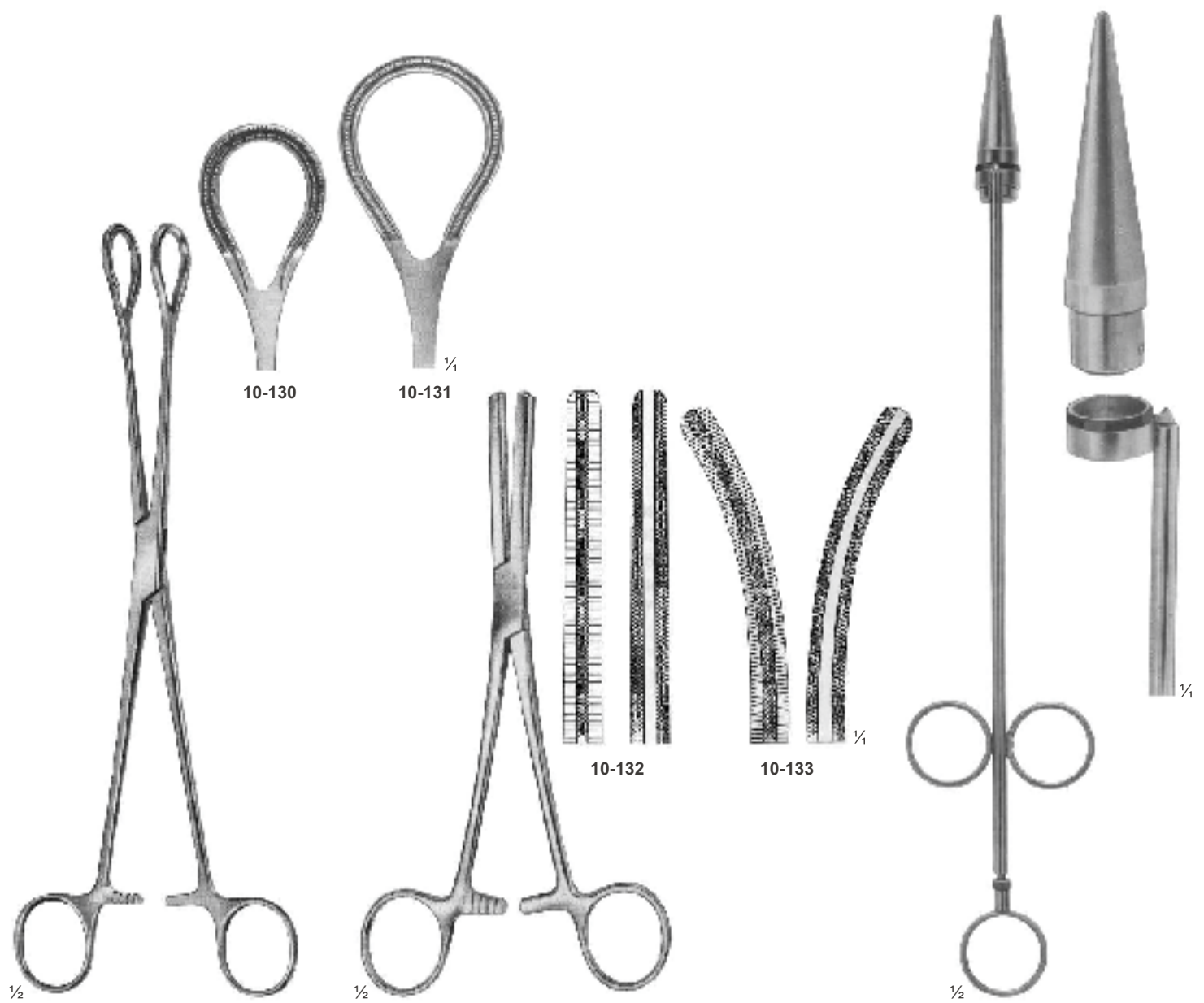

10-130 - 131
250 mm
10-131
270 mm

10-132 - 133
FERGUSSON
200 mm

10-134
RUDD
Haemorrhoidal ligator
with loading
attachment and 100
ligature rubber rings
315 mm

Gall Duct Forceps



10-135
LOWER
180 mm



10-136
LAHEY (SWEET)
190 mm



10-137
LAHEY
220 mm



10-138
DESJARDINS
Gall duct-and cystic forceps

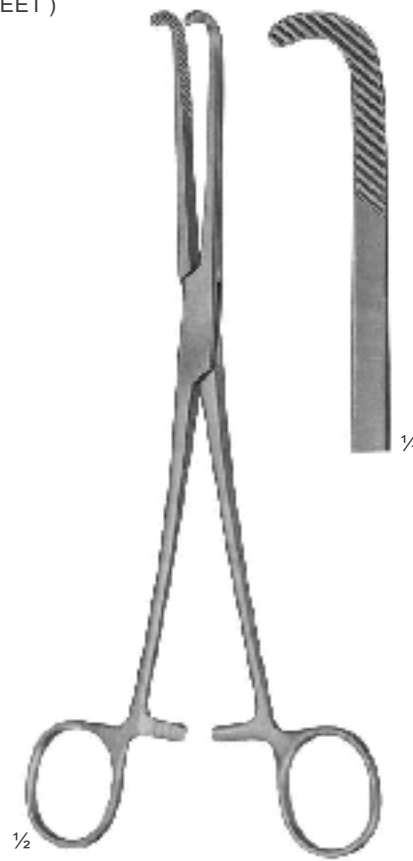

10-139
NISSEN
Gall duct-and cystic forceps
215 mm

Gall Duct Forceps and Choledochus Forceps

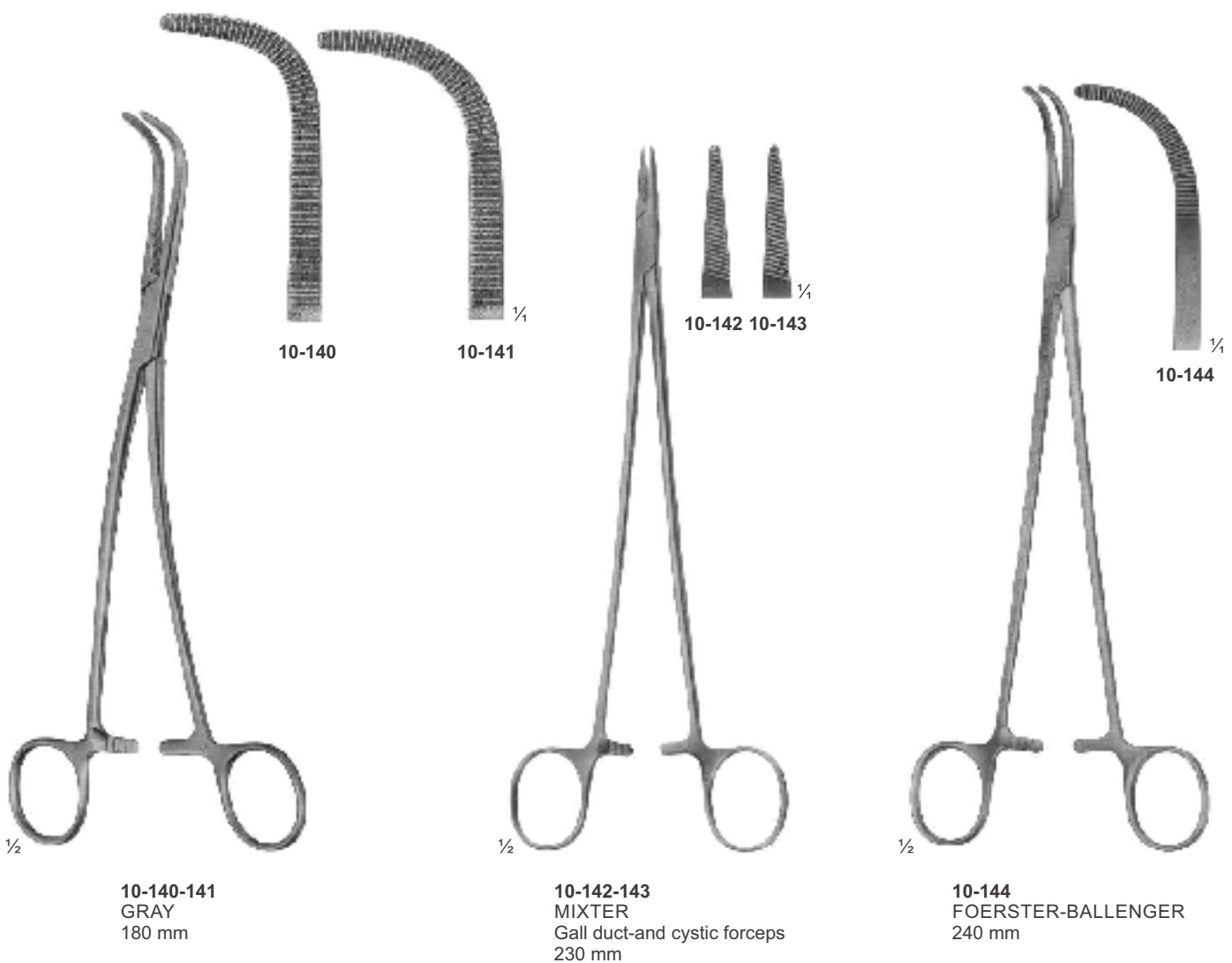

Gall Bladder Forceps and Gall Duct Scissors

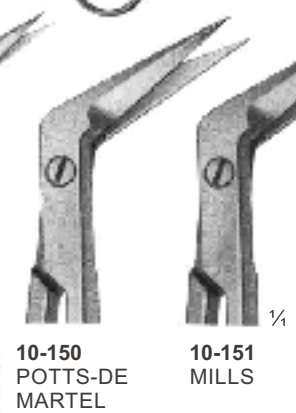
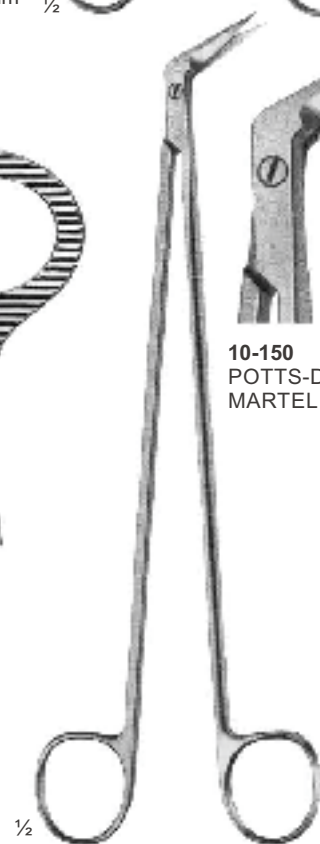
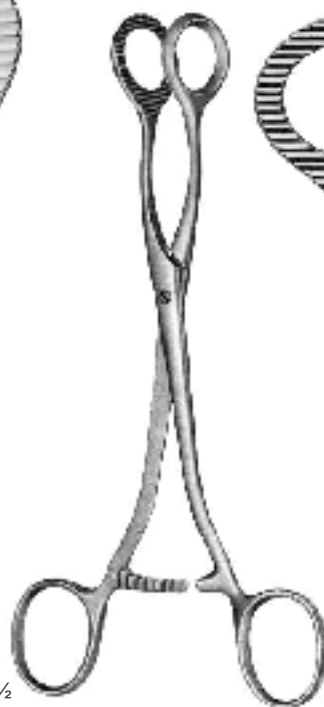
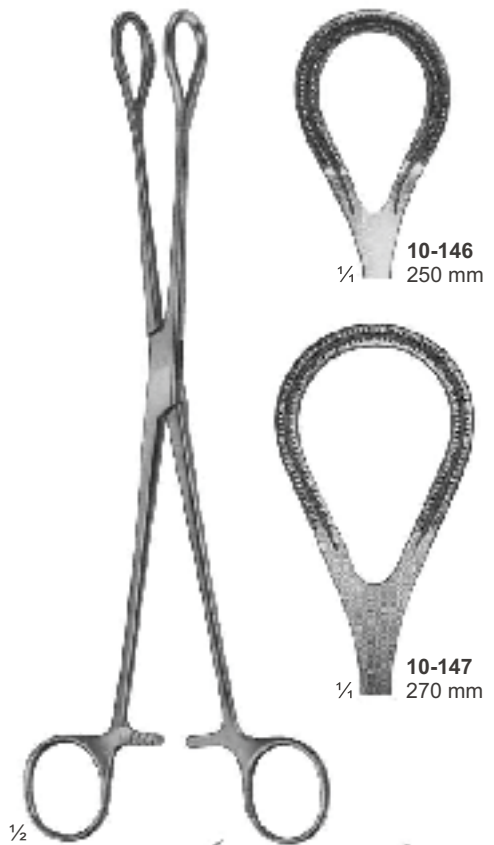
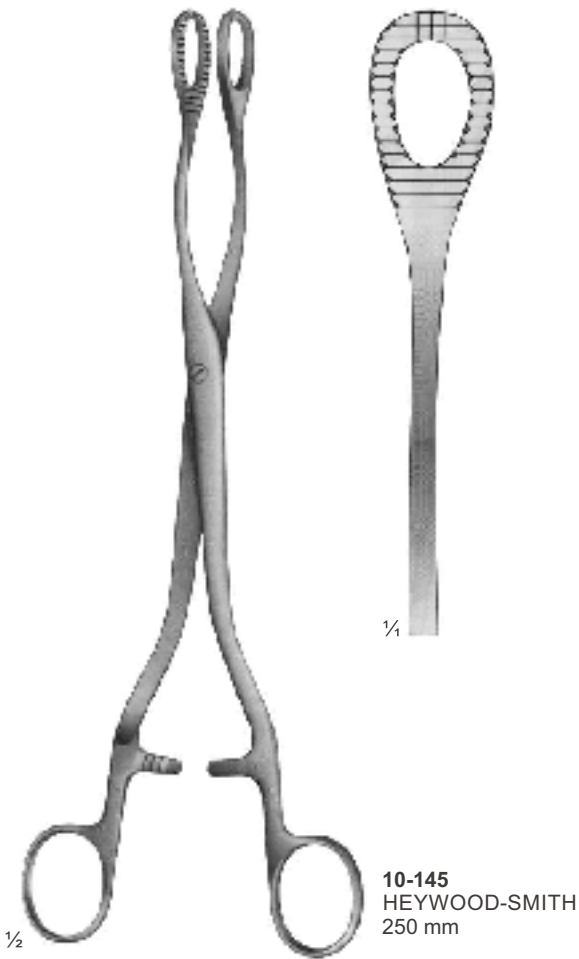

Gall Duct Probes

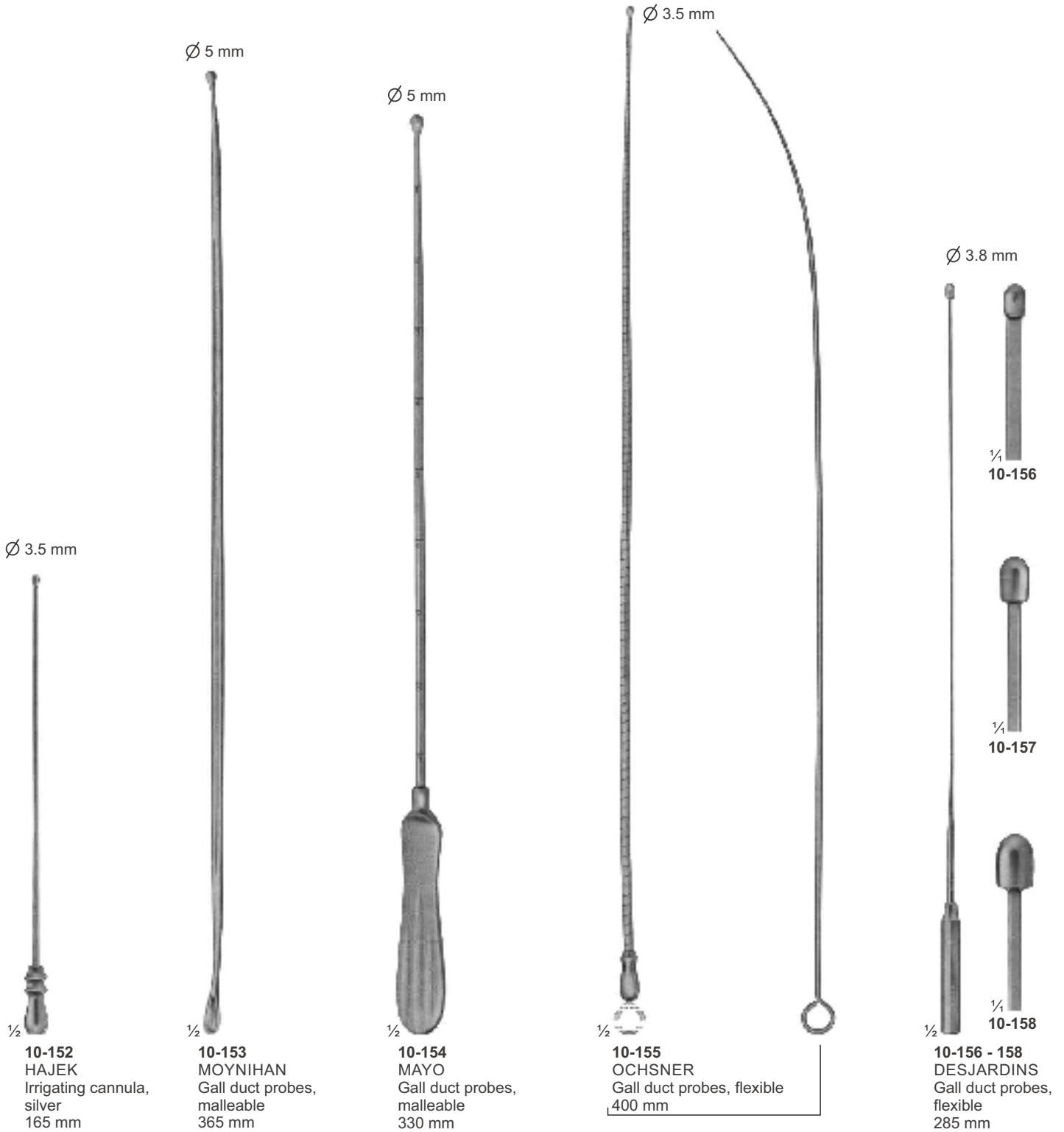

Gall Duct Dilators & Gall Stone Scoops

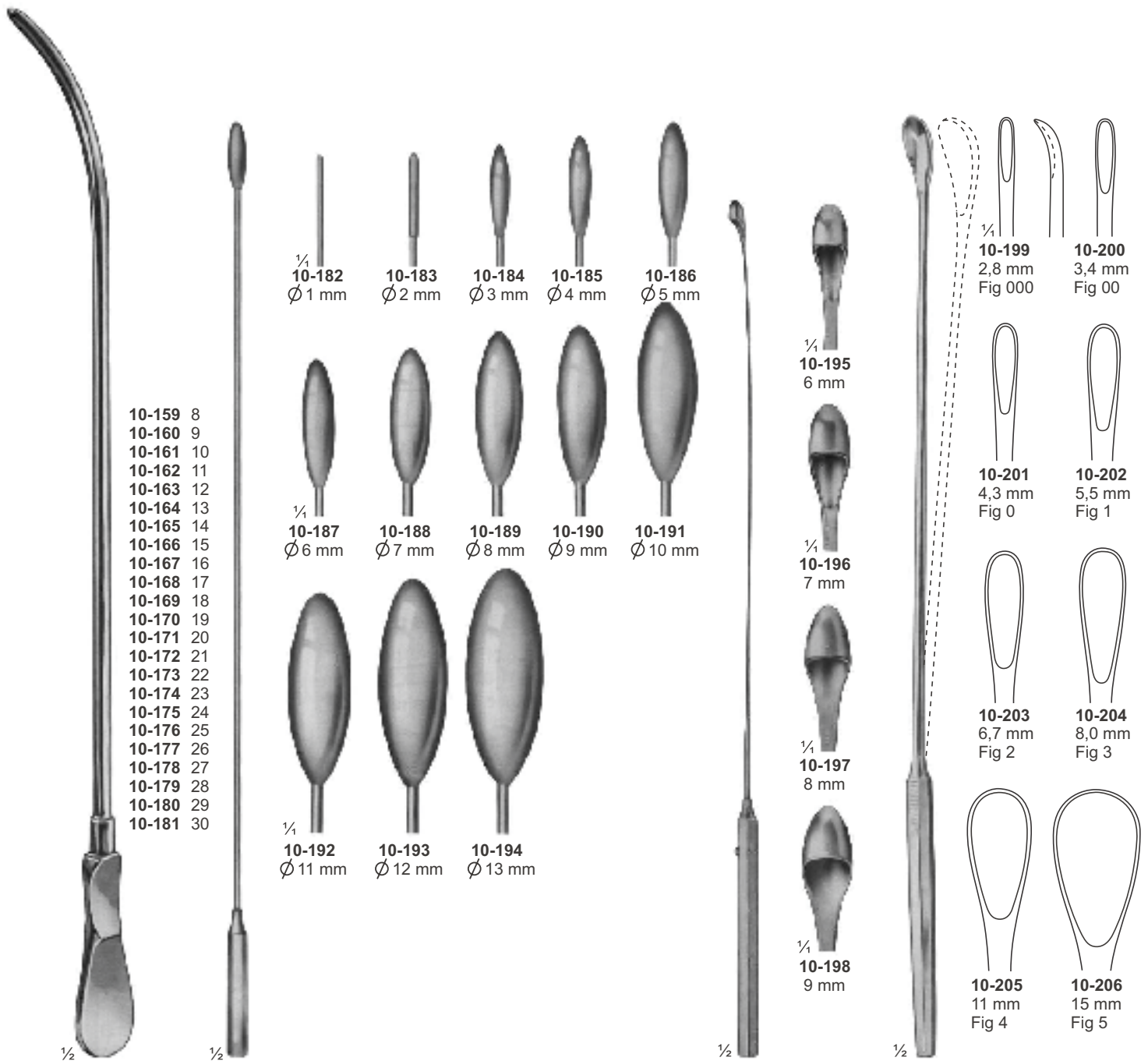

- 10-159 8
- 10-160 9
- 10-161 10
- 10-162 11
- 10-163 12
- 10-164 13
- 10-165 14
- 10-166 15
- 10-167 16
- 10-168 17
- 10-169 18
- 10-170 19
- 10-171 20
- 10-172 21
- 10-173 22
- 10-174 23
- 10-175 24
- 10-176 25
- 10-177 26
- 10-178 27
- 10-179 28
- 10-180 29
- 10-181 30

10-159 - 181
DITTEL
Metall bougies and
dilating sounds, stiff
345 mm

10-182 - 194
BAKES
Common bile duct
dilators, malleable
315 mm, 320 mm

10-195 - 198
DESJARDINS
Probes and catch
with flexible shaft
300 mm

10-199 - 206
LUER-KORTE modif
with malleable shaft
310 mm

Gall Stone Forceps

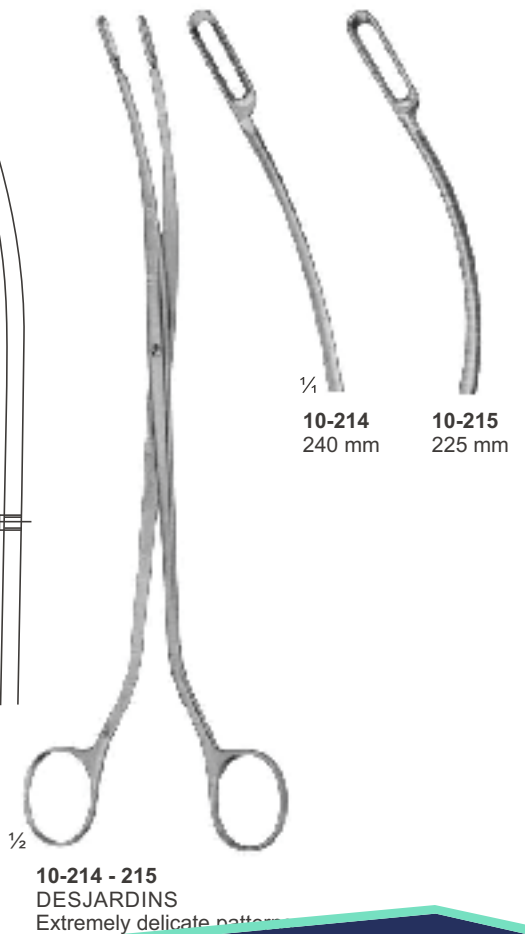
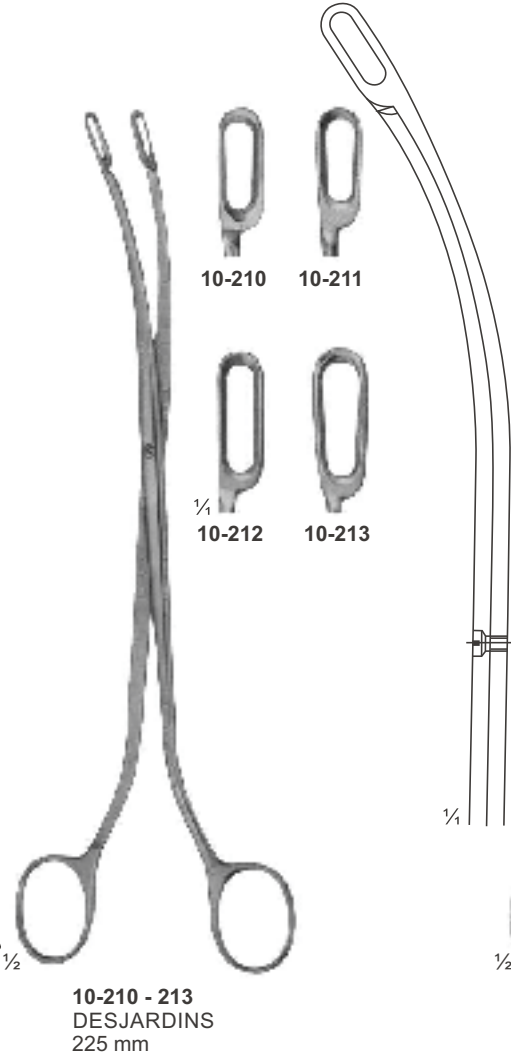
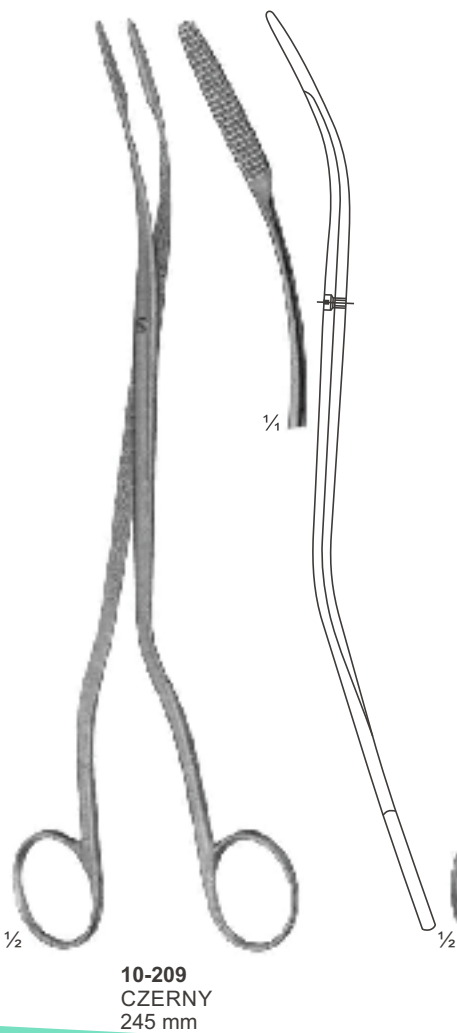
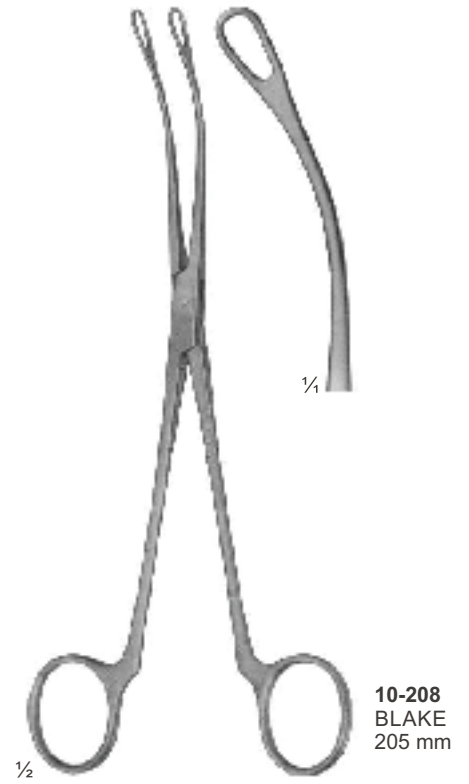
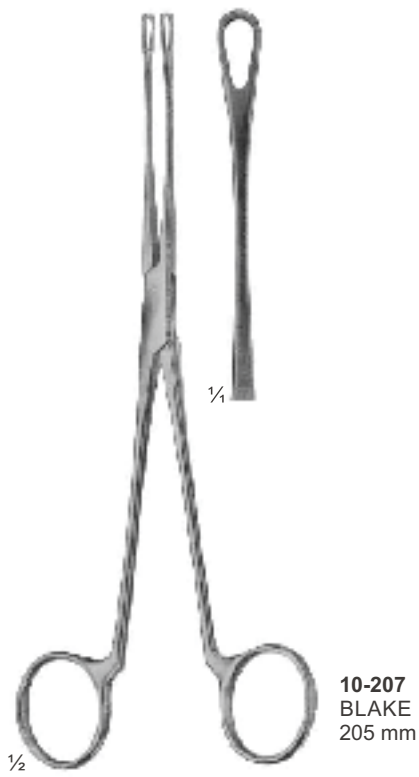

Kidney Clamps

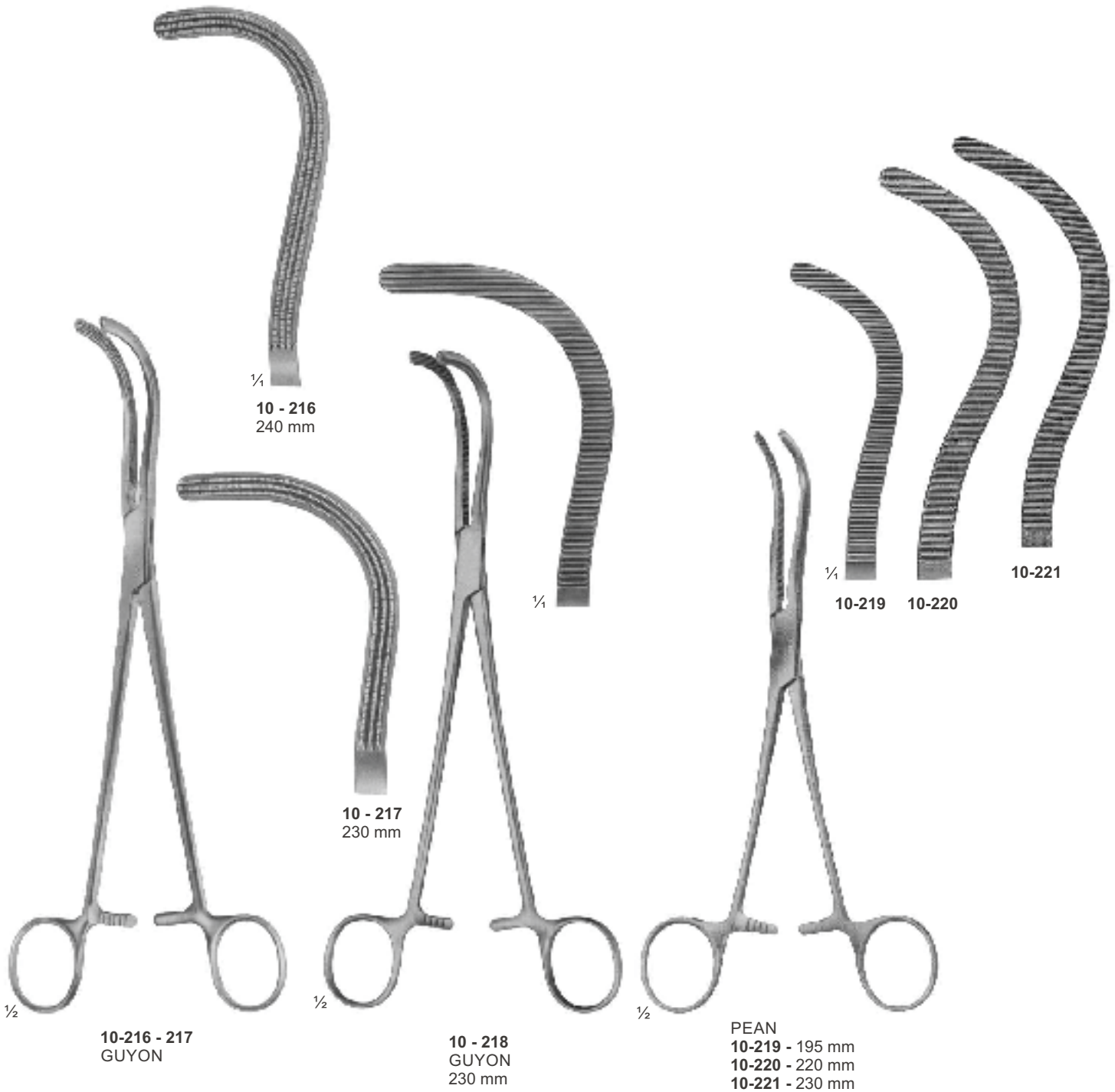

Kidney Clamps

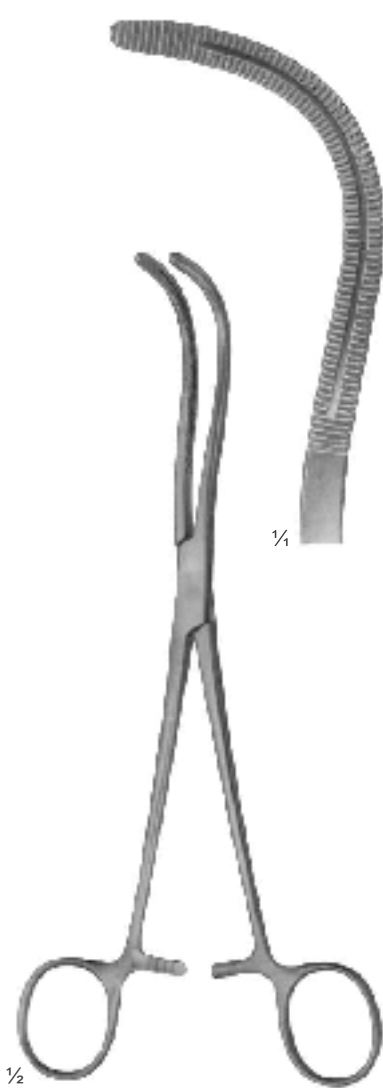

10-222
STILLE
220 mm

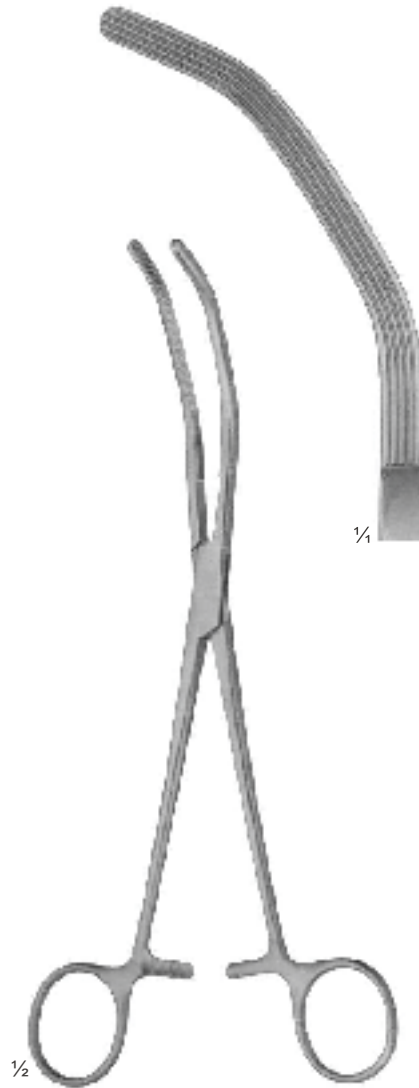

10-223
HERRICK
225 mm

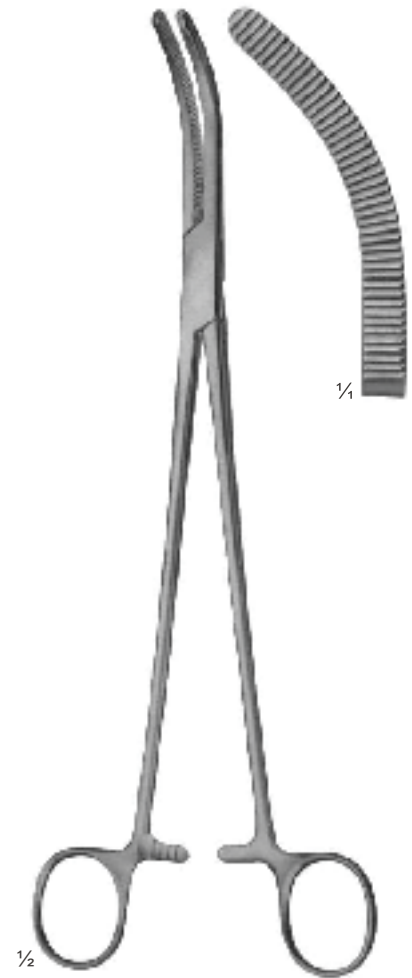

10-224
WERTHEIM
225 mm

Kidney Elevating Forceps



10-225
COLLIN
285 mm

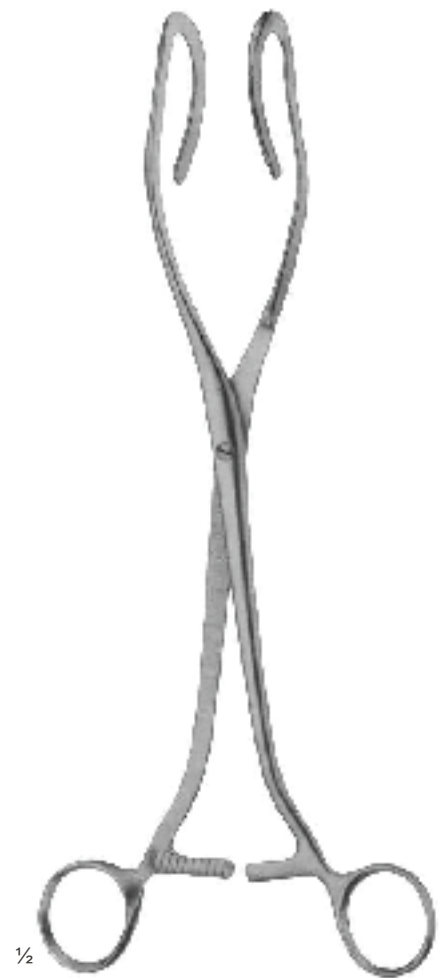

10-226
DARTIGUES
255 mm

Kidney Stone Forceps



10-227



10-228



10-229



$\frac{1}{4}$
10-230



$\frac{1}{2}$

10-227 - 230
RANDALL
225 mm



10-231



10-232



$\frac{1}{4}$
10-233



$\frac{1}{2}$

10-231 - 233
RANDALL
190 mm

Bladder Retractors

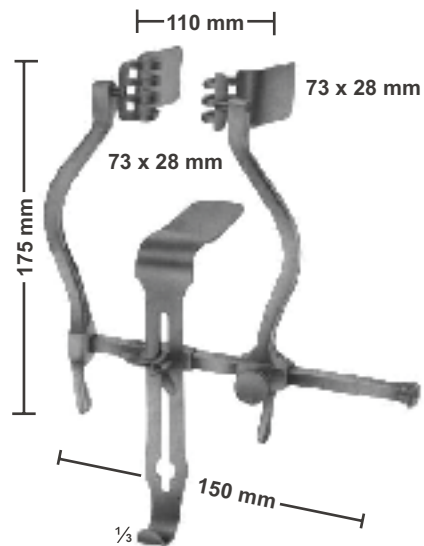

11-101
JUDD-MASSON
Bladder-and suprapubic
retractor



11-102
MILLIN
Bladder retractor
105X45 mm



11-103
LEGUEU
Bladder retractor
Center blade
80 x 31 mm

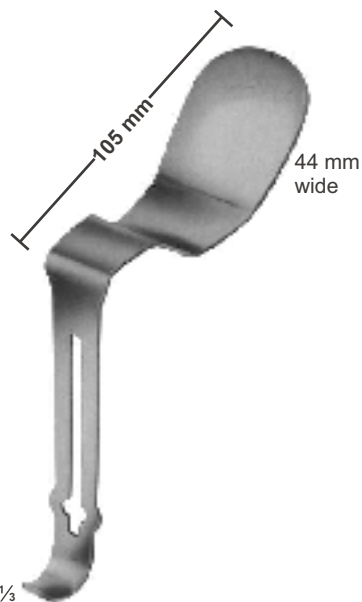

11-104
MILLIN
Center bladder for
retro pubic prostatectomy

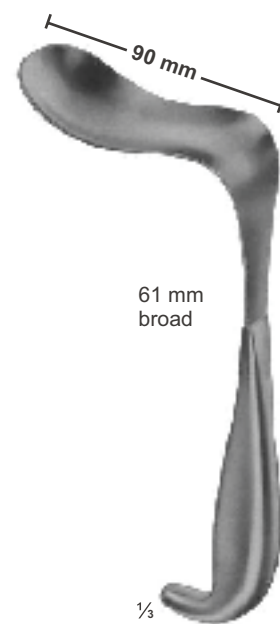

11-105
KOCHER
Bladder spatula
235 mm

Genito-Urinary Instruments-Prostatectomy



11-106
MATHIEU
Foreign body forceps
Length of shaft
190 mm

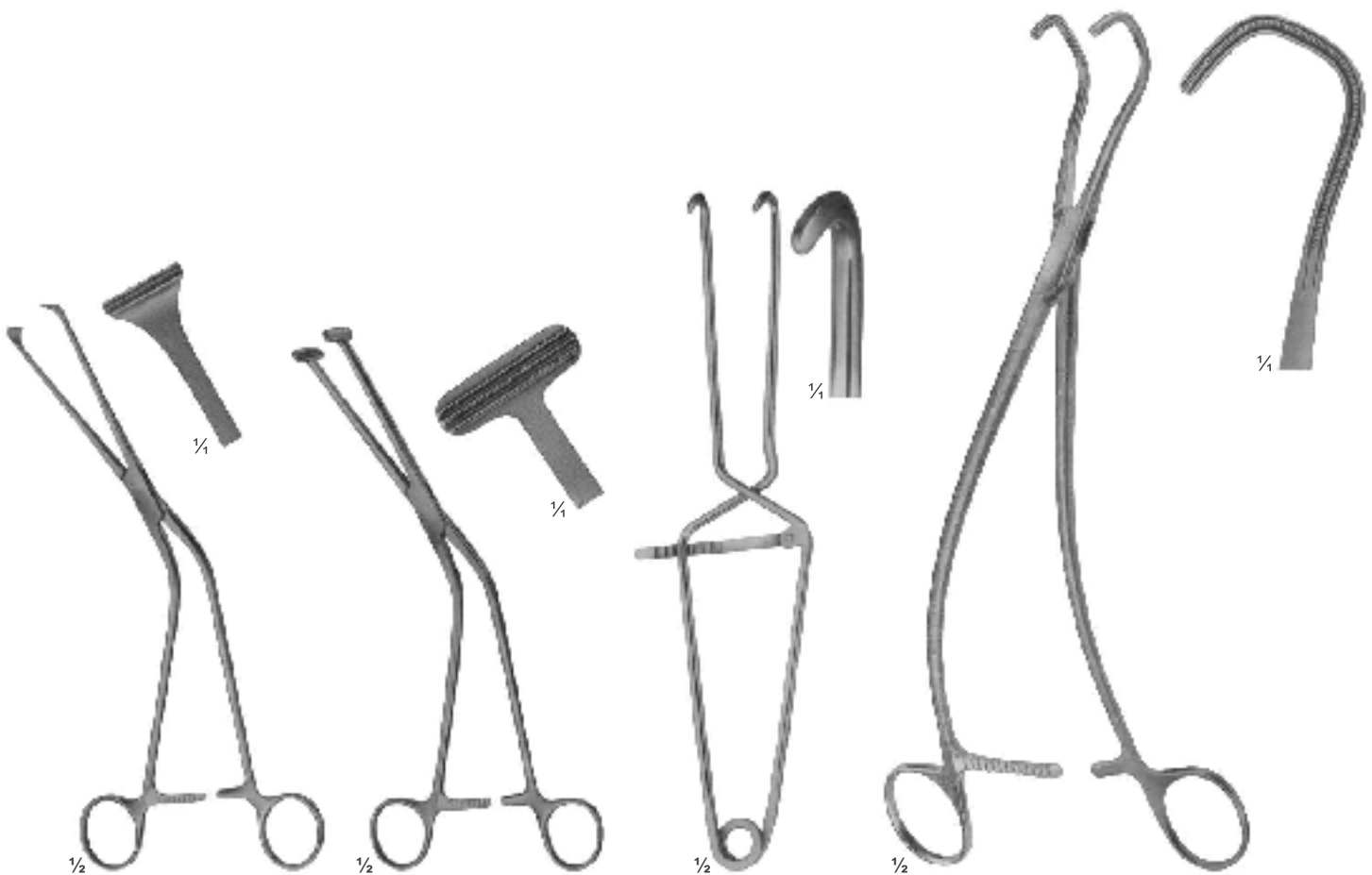

11-107
MILLIN
Lobe grasping
forceps
245 mm

11-108
MILLIN
Lobe grasping
forceps
235 mm

11-109
MILLIN
Bladder neck spreader
285 mm

11-110
Ureter forceps
240 mm

Genito-Urinary Instruments



11-111
GUYON
Catheter guide
(introducer)
365 mm

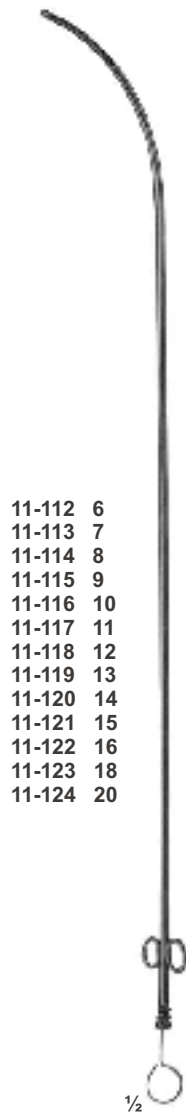

11-112 6
11-113 7
11-114 8
11-115 9
11-116 10
11-117 11
11-118 12
11-119 13
11-120 14
11-121 15
11-122 16
11-123 18
11-124 20

11-112 - 124
Female catheters,
metal
160 mm

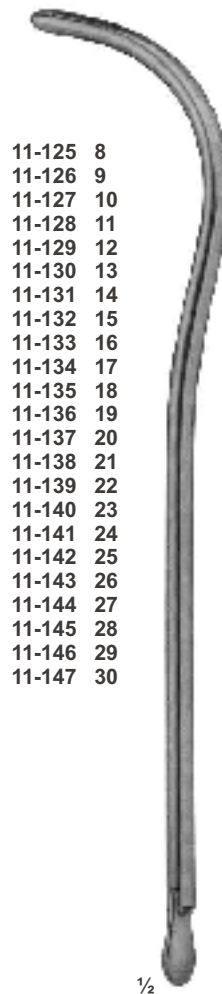

11-125 8
11-126 9
11-127 10
11-128 11
11-129 12
11-130 13
11-131 14
11-132 15
11-133 16
11-134 17
11-135 18
11-136 19
11-137 20
11-138 21
11-139 22
11-140 23
11-141 24
11-142 25
11-143 26
11-144 27
11-145 28
11-146 29
11-147 30

11-125 - 147
Urethral bougies
and dilating sounds
345 mm

11-148 Ben. 24/Charr. 12
11-149 Ben. 25
11-150 Ben. 26/Charr. 13
11-151 Ben. 27
11-152 Ben. 28/Charr. 14
11-153 Ben. 29
11-154 Ben. 30/Charr. 15
11-155 Ben. 31
11-156 Ben. 32/Charr. 16
11-157 Ben. 33
11-158 Ben. 34/Charr. 17
11-159 Ben. 35
11-160 Ben. 36/Charr. 18
11-161 Ben. 37
11-162 Ben. 38/Charr. 19
11-163 Ben. 39
11-164 Ben. 40/Charr. 20
11-165 Ben. 41
11-166 Ben. 42/Charr. 21
11-167 Ben. 43
11-168 Ben. 44/Charr. 22
11-169 Ben. 45
11-170 Ben. 46/Charr. 23
11-171 Ben. 47
11-172 Ben. 48/Charr. 24
11-173 Ben. 49
11-174 Ben. 50/Charr. 25
11-175 Ben. 51
11-176 Ben. 52/Charr. 26
11-177 Ben. 53
11-178 Ben. 54/Charr. 27
11-179 Ben. 55
11-180 Ben. 56/Charr. 28
11-181 Ben. 57
11-182 Ben. 58/Charr. 29
11-183 Ben. 59
11-184 Ben. 60/Charr. 30

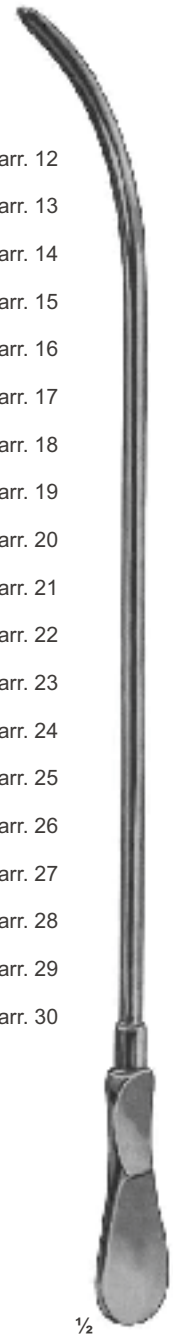

11-148 - 184
Urethral bougies
and dilating sounds
255 mm

Genito-Urinary Instruments & Circumcision Clamps

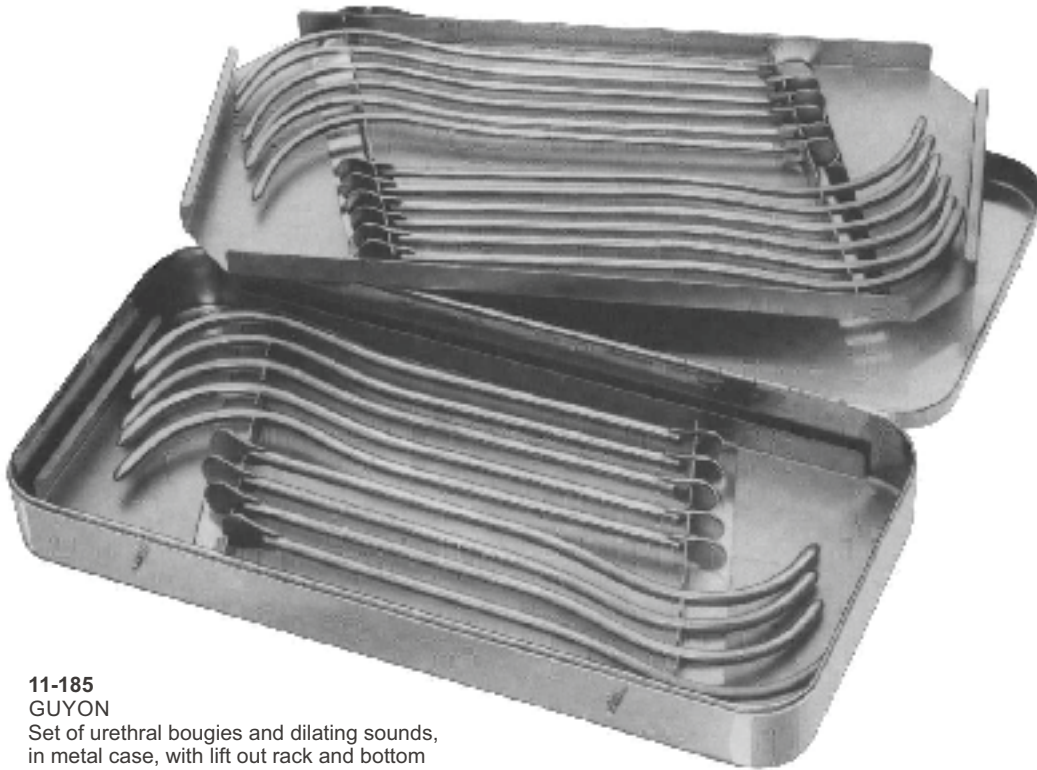

11-185
GUYON
Set of urethral bougies and dilating sounds,
in metal case, with lift out rack and bottom
rack, containing 21 urethral and dilating sounds.

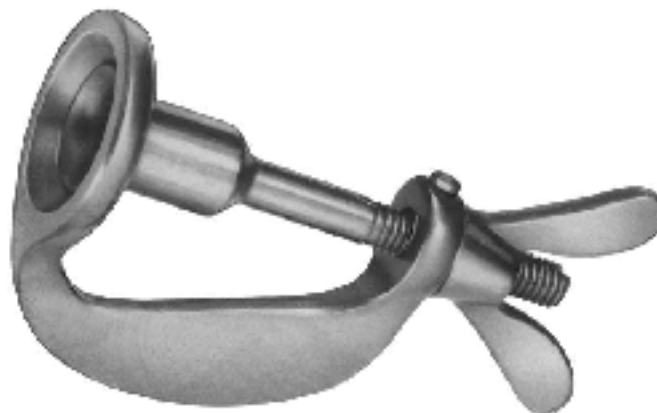

11-186
WINKELMANN

Circumcision Clamps

12 mm / 16 mm / 20 mm

Trocars



11-187
KLIMA ROSEGGER
35 X 1,8 mm
Sternal puncture needle

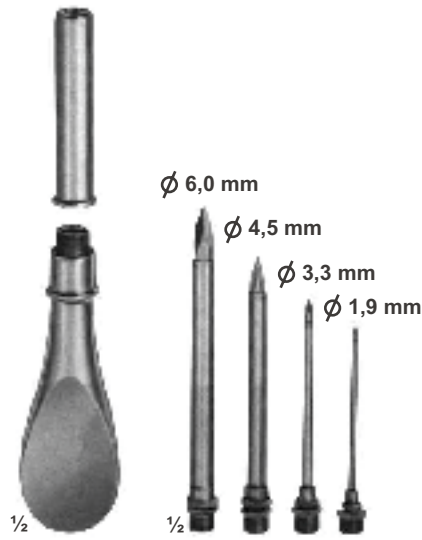

11-188
Universal trocar
with 4 tips



11-189 - 193
Inside dime. Outside dime
11-189 2,2 mm 3,0 mm
11-190 3,0 mm 4,0 mm
11-191 4,0 mm 5,0 mm
11-192 5,0 mm 6,0 mm
11-193 5,5 mm 6,5 mm
for hydrocele and abdominal
puncture



11-194 - 197
Inside dime. Outside dime
11-194 2,2 mm 3,0 mm
11-195 3,0 mm 4,0 mm
11-196 4,0 mm 5,0 mm
11-197 5,0 mm 6,0 mm
for abdominal puncture,
with stop-cock and lateral
drain

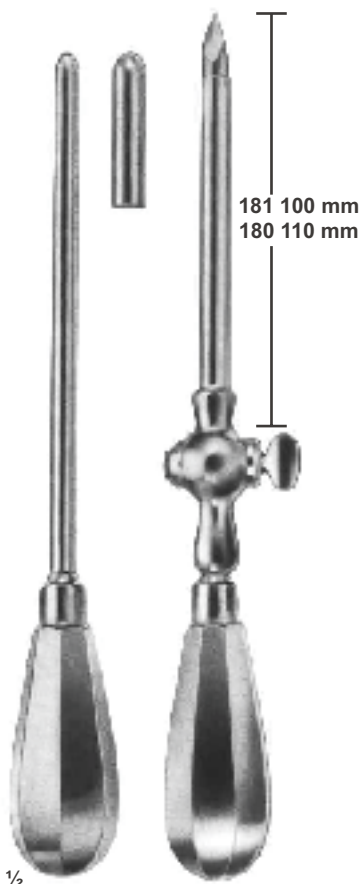

11-198 - 199
Inside dime. Outside dime
11-198 6,5 mm 8,0 mm
11-199 9,0 mm 10,0 mm
Empyema trocar

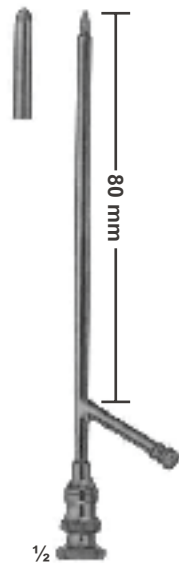

11-200 - 203
Inside dime. Outside dime
11-200 3,0 mm 4,0 mm
11-201 3,6 mm 4,6 mm
11-202 4,3 mm 5,3 mm
11-203 5,0 mm 6,0 mm
Gall bladder trocars



11-204
PIERCE
Antrum trocar
4,0 mm

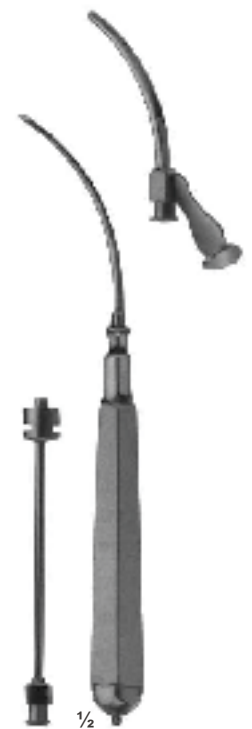

11-205
COAKLEY
Antrum trocar
3,0 mm

Vaginal specula

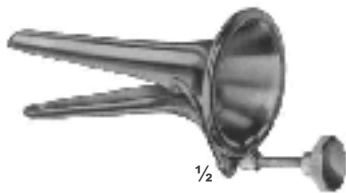

12-101
COLLIN
for children
53 x 10 mm

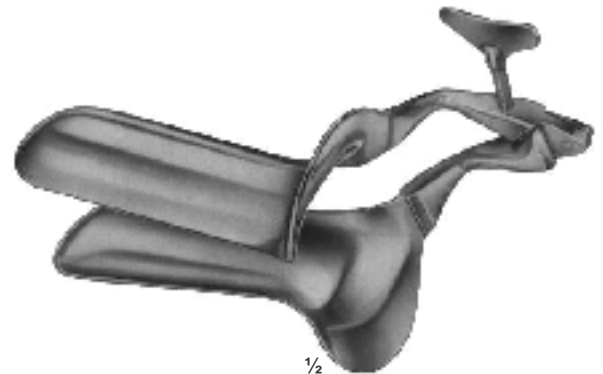

12-102 - 105
COLLIN

| | | |
|-----------------------------|-----------|-------|
| 12-102 | 100/90mm | 28 mm |
| 12-103 | 100/90mm | 32 mm |
| 12-104 | 105/95mm | 35 mm |
| 12-105 | 115/105mm | 40 mm |
| Total length/working length | | width |



12-106
COLLIN
for virgins
95/85 x 18 mm

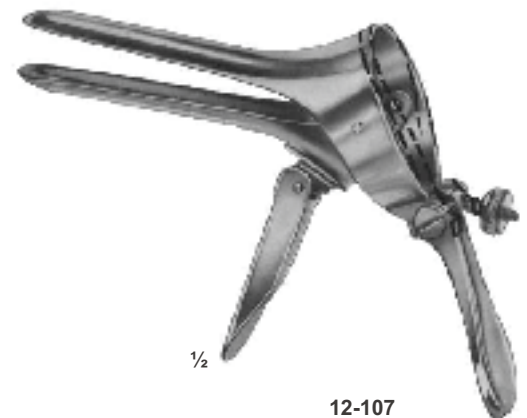

12-107
CUSCO
for virgins
75 x17 mm



12-108
CUSCO
for virgins
75 x17 mm



12-109 - 111
CUSCO

| | |
|---------------|--------------|
| 12-109 | 92X23-25 mm |
| 12-110 | 100x25-27 mm |
| 12-111 | 110x27-30 mm |

Vaginal Specula



12-112 - 115
CUSCO
STANDARD
12-112 80X24 mm
12-113 80X32 mm
12-114 90X36 mm
12-115 110X37 mm



12-116 - 119
CUSCO
12-116 80X24 mm
12-117 80X32 mm
12-118 90X36 mm
12-119 110X37 mm



12-120 - 122
CUSCO
12-120 80X24 mm
12-121 80X32 mm
12-122 115X36 mm

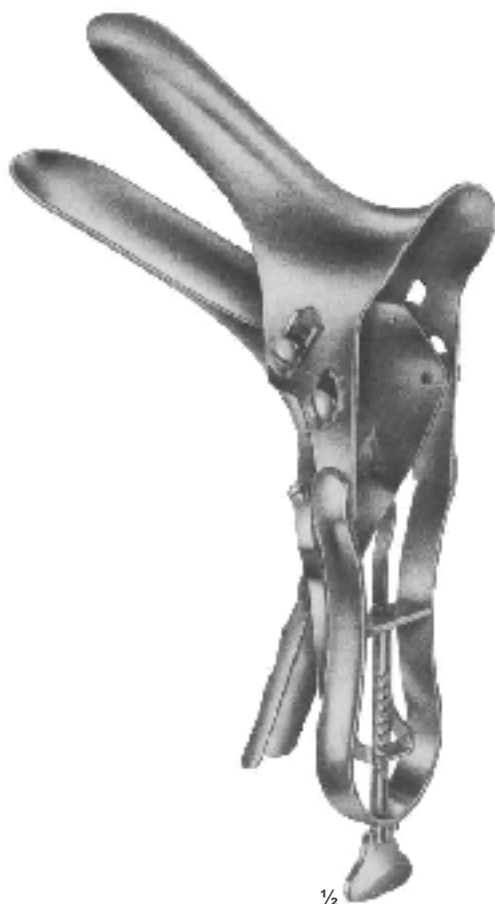

12-123 - 124
SEYFFERT
12-123 100X24 mm
12-124 110X32 mm
230 mm



12-125
SEMM
for children
and virgins
180 mm

Vaginal Specula, Sets, Upper & Lower Blades

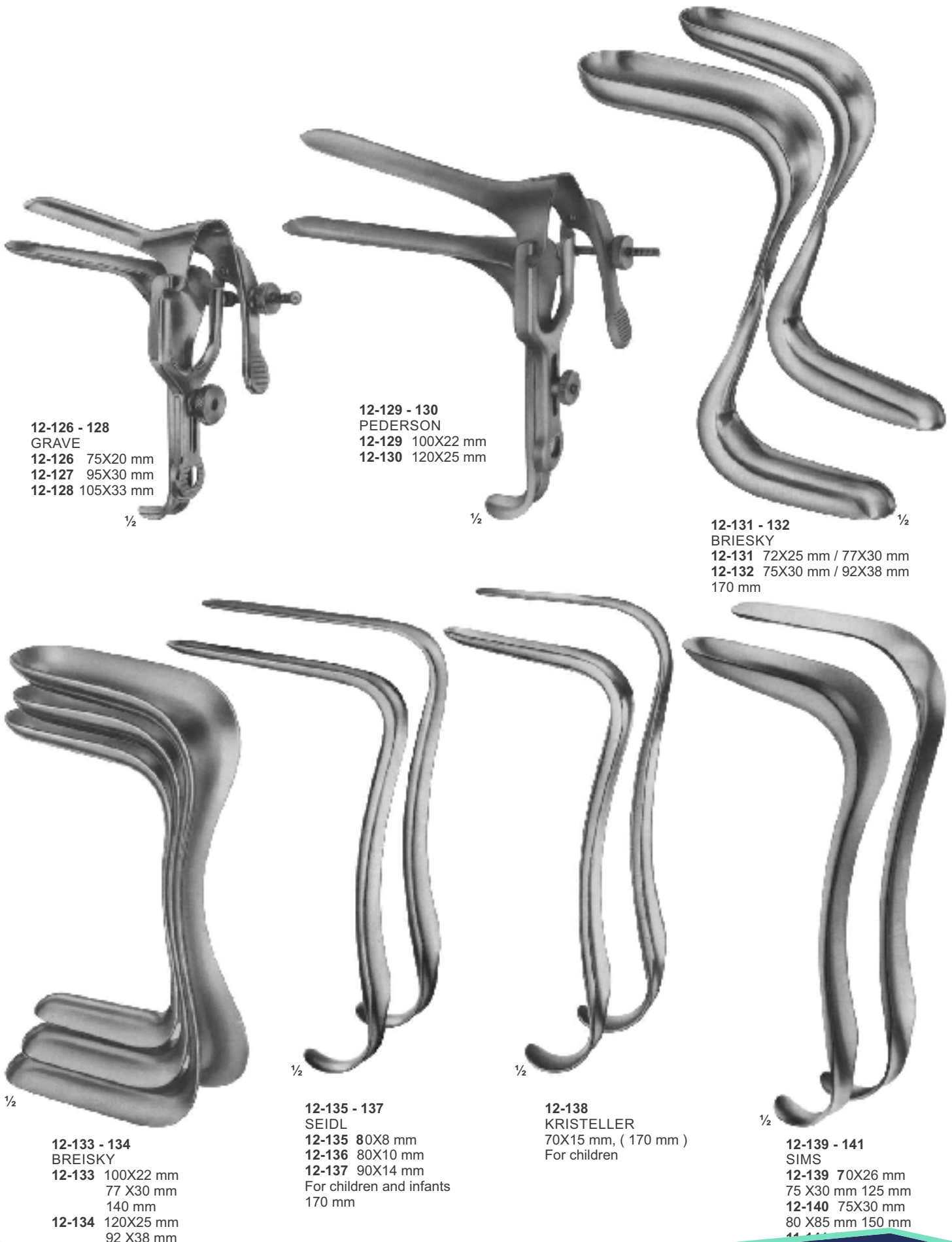

12-126 - 128
GRAVE
12-126 75X20 mm
12-127 95X30 mm
12-128 105X33 mm

1/2

12-129 - 130
PEDERSON
12-129 100X22 mm
12-130 120X25 mm

1/2

12-131 - 132
BRIESKY
12-131 72X25 mm / 77X30 mm
12-132 75X30 mm / 92X38 mm
170 mm

1/2



1/2

12-133 - 134
BRIESKY
12-133 100X22 mm
77 X30 mm
140 mm
12-134 120X25 mm
92 X38 mm



1/2

12-135 - 137
SEIDL
12-135 80X8 mm
12-136 80X10 mm
12-137 90X14 mm
For children and infants
170 mm



1/2

12-138
KRISTELLER
70X15 mm, (170 mm)
For children



1/2

12-139 - 141
SIMS
12-139 70X26 mm
75 X30 mm 125 mm
12-140 75X30 mm
80 X85 mm 150 mm
11 X11 mm

Vaginal Specula-Sets, upper and lower blades

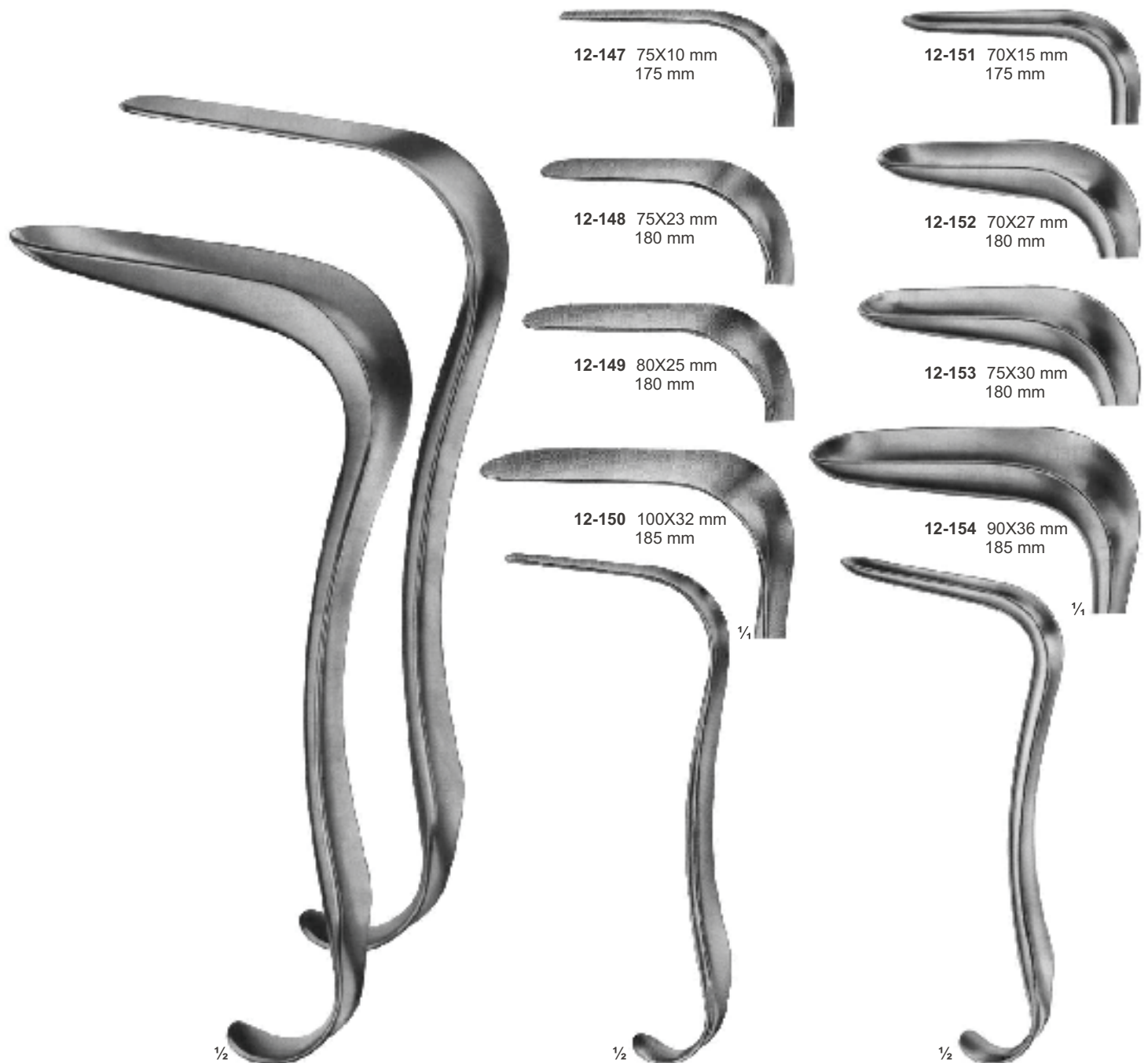

12-142 - 146
KRISTELLER
12-142 110X18 mm
12-143 110X20 mm
12-144 110X27 mm
12-145 110X30 mm
12-146 110X36 mm
220 mm

12-147 - 150
KRISTELLER
Upper blades

12-151 - 154
KRISTELLER
Lower blades

Vaginal Specula-upper and lower blades

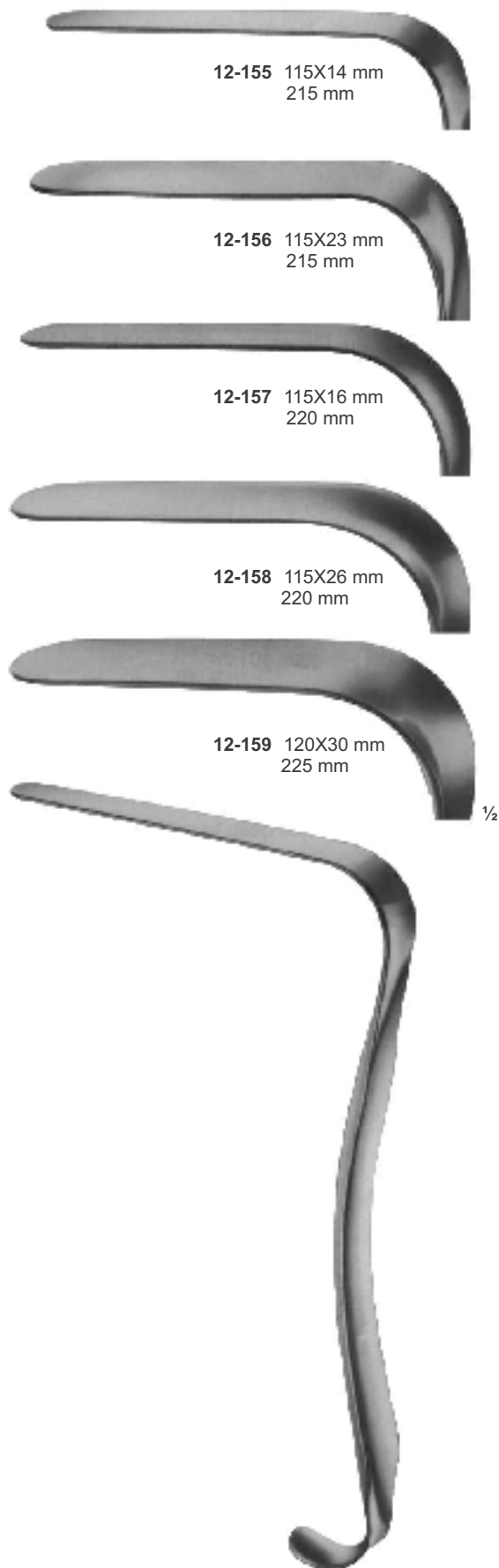

12-155 115X14 mm
215 mm

12-156 115X23 mm
215 mm

12-157 115X16 mm
220 mm

12-158 115X26 mm
220 mm

12-159 120X30 mm
225 mm

12-155 - 159
KRISTELLER
Upper blades

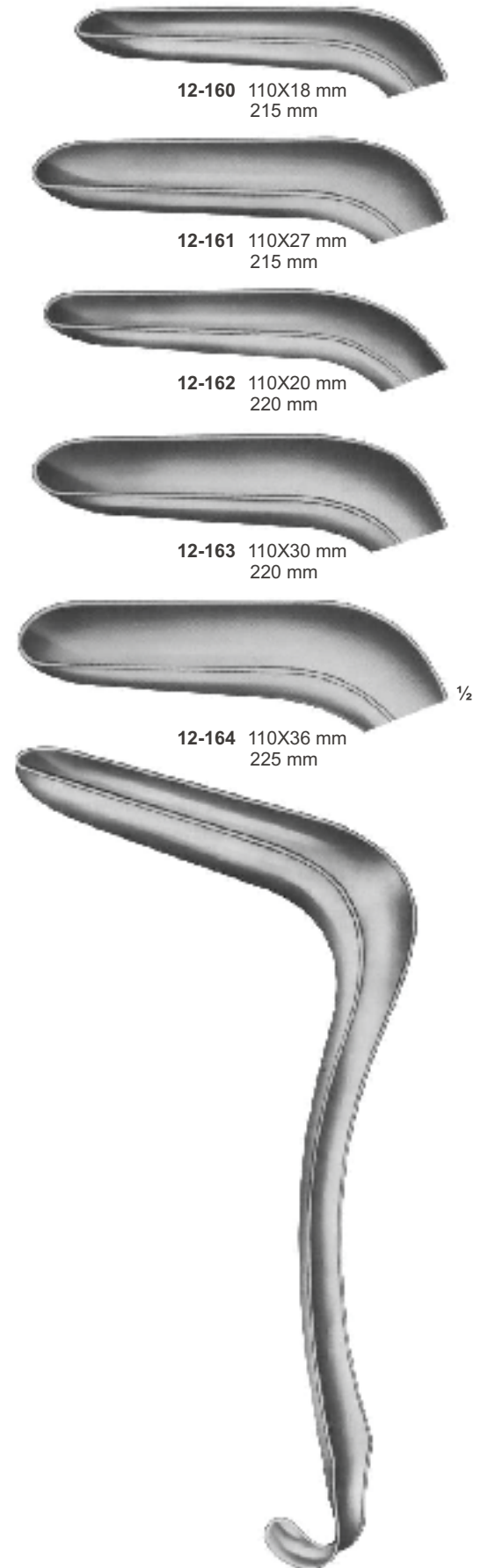

12-160 110X18 mm
215 mm

12-161 110X27 mm
215 mm

12-162 110X20 mm
220 mm

12-163 110X30 mm
220 mm

12-164 110X36 mm
225 mm

12-160 - 164
KRISTELLER
Lower blades

Vaginal Specula

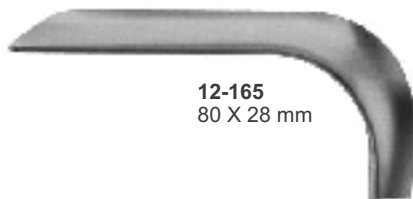

12-165
80 X 28 mm

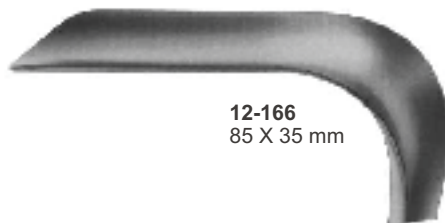

12-166
85 X 35 mm

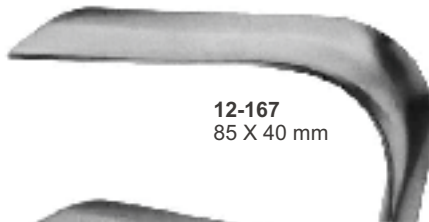

12-167
85 X 40 mm



Slightly Concave

1/2

12-165 - 167
KRISTELLER
205 mm



12-168
76 X 38 mm

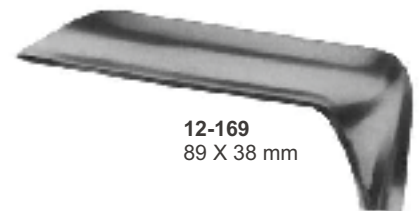

12-169
89 X 38 mm

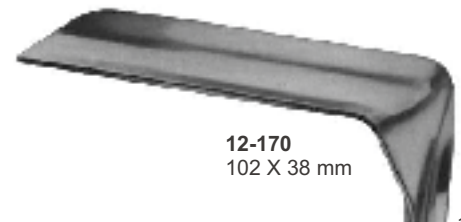

12-170
102 X 38 mm



Slightly Concave

1/2

12-168 - 170
JACKSON
175 mm

Vaginal Specula-for children & virgins Vario Retractor



12-171
BRAUN
180 mm



12-172
BRAUN
180 mm



12-173
MATHIEU
For children
and virgins
210 mm



12-174
MATHIEU
for children and
virgins fitting
210 mm



12-175
Handle with cold light
carrier for upper blades
280 mm

Vaginal Specula-for children and virgins

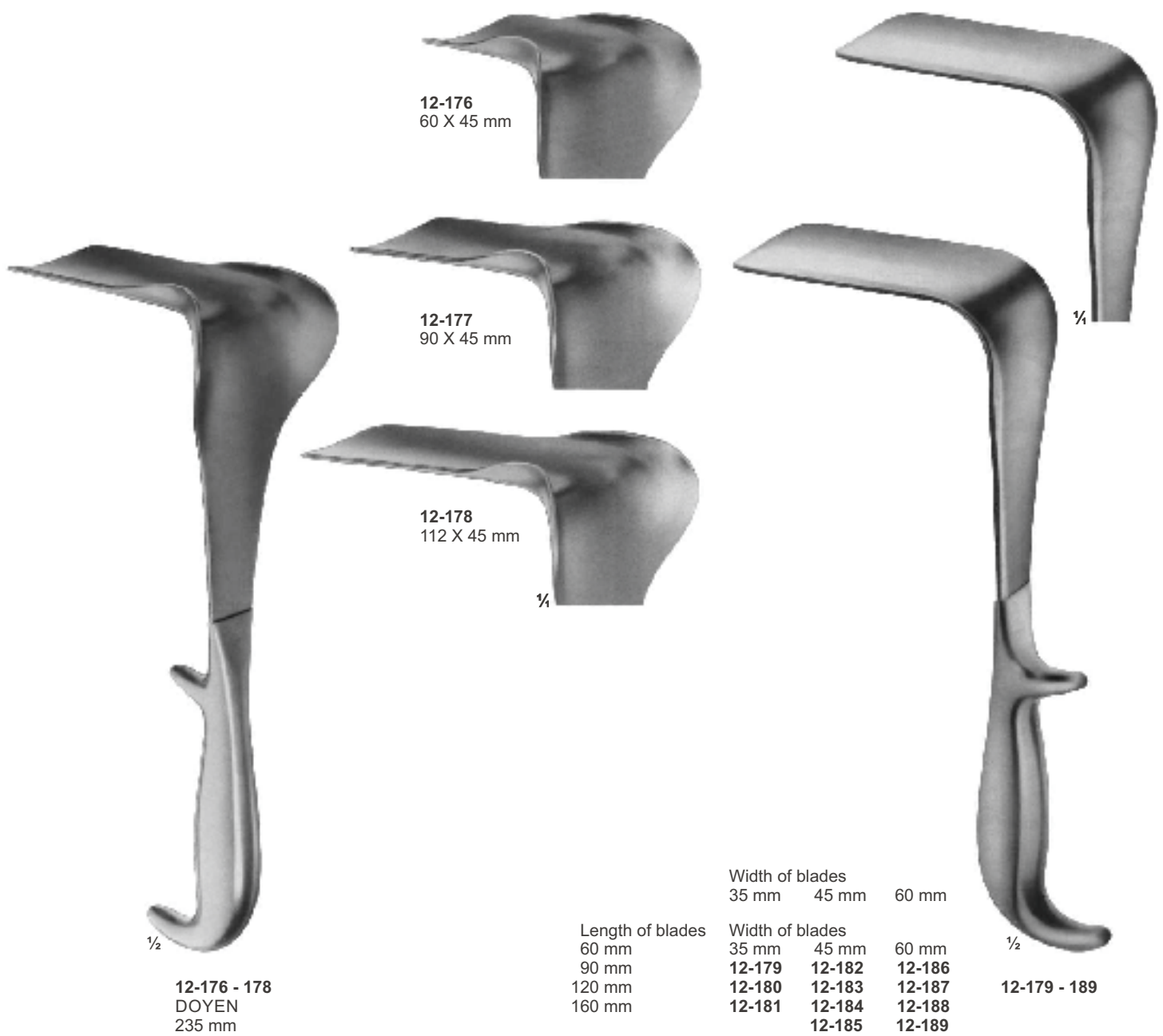

Vaginal Specula / Retractors



1/2

12-190 - 194
BREISKY
WIENER MODELL/
VIENNA PATTERN
12-190 100 X 20 mm
12-191 100 X 25 mm
12-192 100 X 30 mm
12-193 100 X 35 mm
12-194 100 X 40 mm
300 mm



1/2

12-195 - 199
BREISKY
WIENER MODELL/
VIENNA PATTERN
12-195 130 X 20 mm
12-196 130 X 25 mm
12-197 130 X 30 mm
12-198 130 X 35 mm
12-199 130 X 40 mm
320 mm



1/2

12-200 - 201
WEISSBARTH
12-200 80 X 28 mm
12-201 85 X 42 mm
210 mm

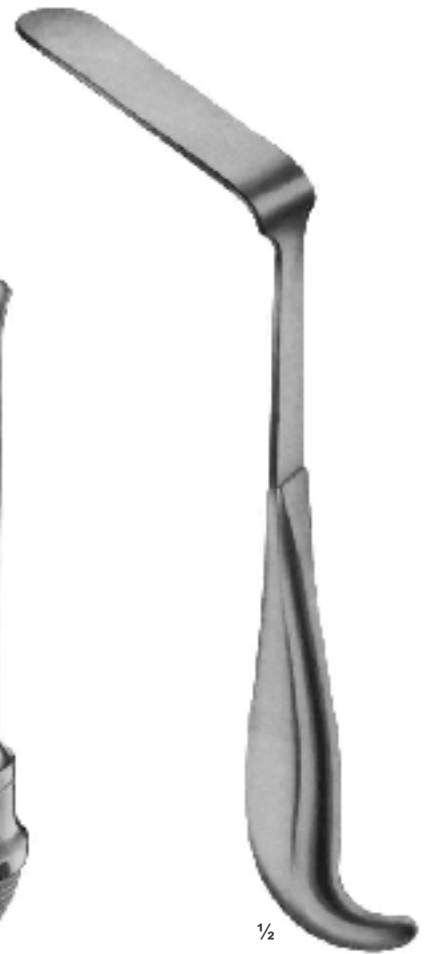

1/2

12-202
DOYEN
lateral speculum
80 x 30 mm
250 mm

Vaginal & Wound Retractor / Vaginal Specula

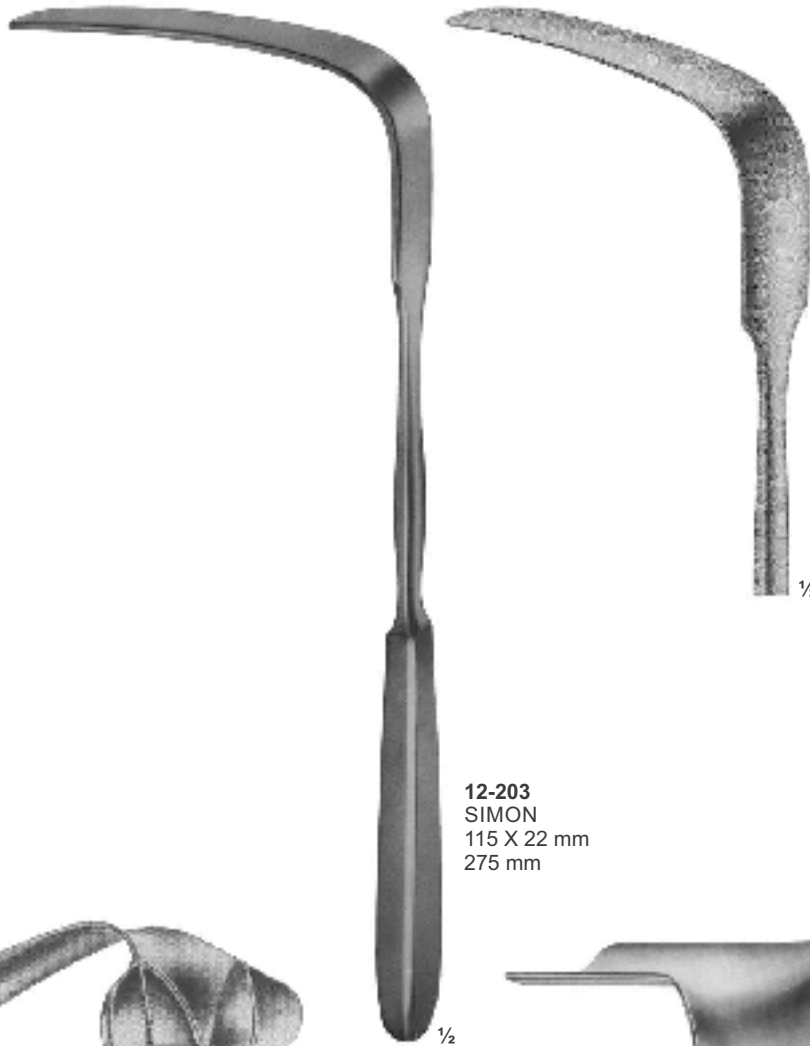

12-203
SIMON
115 X 22 mm
275 mm



12-204
AUVARD
65 X 38 mm - 28 mm
1,530 kg
with fixed weight
230 mm



12-205 - 206
AUVARD
12-205 75 X 42 mm
(40 mm)
12-206 105 X 43 mm
(40 mm)
with detachable wight
230 mm



12-207
MARTIN
with hook shaped
handle for hanging
in weights
270 mm

Vaginal Speculas

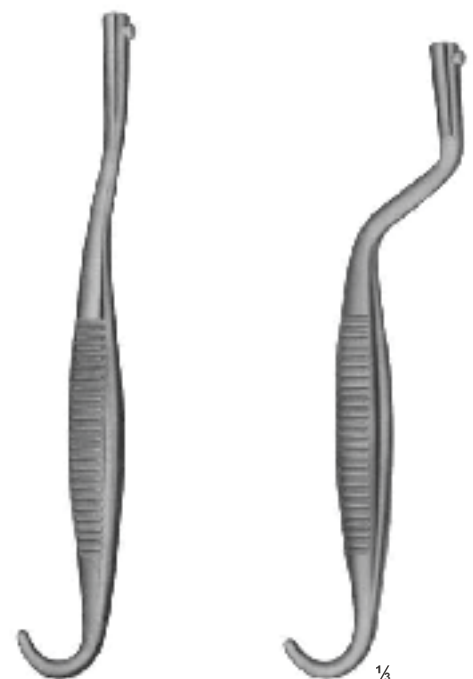
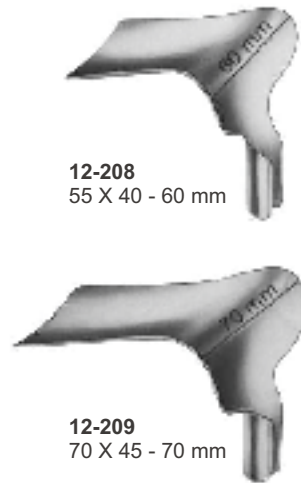
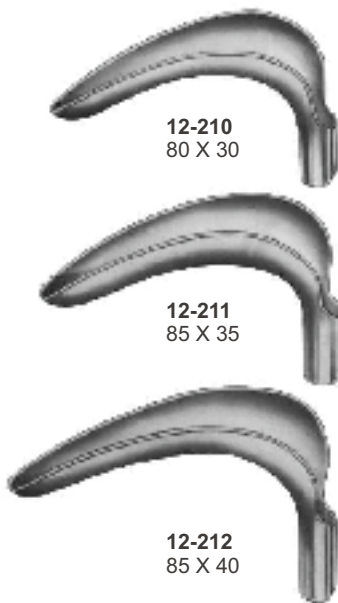

Vaginal Retractors



1/2
12-221
JOLL (FRIEDMAN)
155 mm



1/2
12-222
RICHTER
170 mm

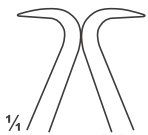

1/2
12-223
GELPI
135 mm

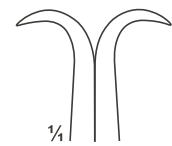

1/2
12-224
GELPI
175 mm

Uterine Dilators



1/2

13-101 - 143
HEGAR
with very conical point
185 mm

| | | | | | |
|---------------|----|----|---------------|----|-------|
| 13-101 | 1 | mm | 13-123 | 23 | mm |
| 13-102 | 2 | mm | 13-124 | 24 | mm |
| 13-103 | 3 | mm | 13-125 | 25 | mm |
| 13-104 | 4 | mm | 13-126 | 26 | mm |
| 13-105 | 5 | mm | 13-127 | 1 | 1/2mm |
| 13-106 | 6 | mm | 13-128 | 2 | 1/2mm |
| 13-107 | 7 | mm | 13-129 | 3 | 1/2mm |
| 13-108 | 8 | mm | 13-130 | 4 | 1/2mm |
| 13-109 | 9 | mm | 13-131 | 5 | 1/2mm |
| 13-110 | 10 | mm | 13-132 | 6 | 1/2mm |
| 13-111 | 11 | mm | 13-133 | 7 | 1/2mm |
| 13-112 | 12 | mm | 13-134 | 8 | 1/2mm |
| 13-113 | 13 | mm | 13-135 | 9 | 1/2mm |
| 13-114 | 14 | mm | 13-136 | 10 | 1/2mm |
| 13-115 | 15 | mm | 13-137 | 11 | 1/2mm |
| 13-116 | 16 | mm | 13-138 | 12 | 1/2mm |
| 13-117 | 17 | mm | 13-139 | 13 | 1/2mm |
| 13-118 | 18 | mm | 13-140 | 14 | 1/2mm |
| 13-119 | 19 | mm | 13-141 | 15 | 1/2mm |
| 13-120 | 20 | mm | 13-142 | 16 | 1/2mm |
| 13-121 | 21 | mm | 13-143 | 17 | 1/2mm |
| 13-122 | 22 | mm | | | |



1/2

13-144 - 152
HEGAR
205 mm

| | | |
|---------------|-------|----|
| 13-144 | 1+2 | mm |
| 13-145 | 3+4 | mm |
| 13-146 | 5+6 | mm |
| 13-147 | 7+8 | mm |
| 13-148 | 9+10 | mm |
| 13-149 | 11+12 | mm |
| 13-150 | 13+14 | mm |
| 13-151 | 15+16 | mm |
| 13-152 | 17+18 | mm |

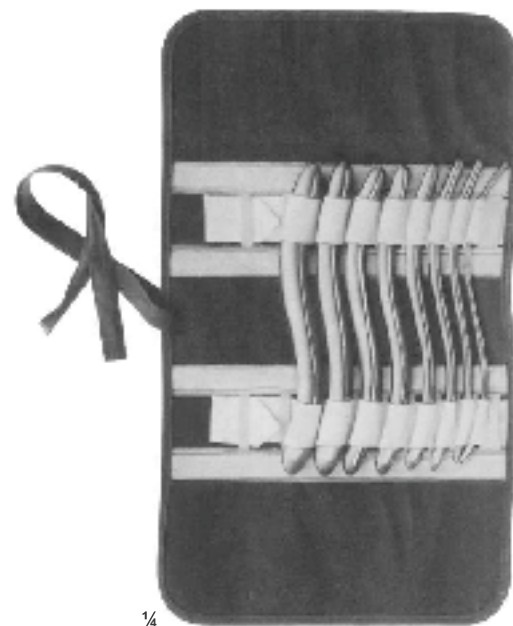

1/4

13-153
HEGAR
Uterine dilator set, in canvas
roll with 8 dilators.

Uterine Dilators - Complete Sets



13-154
HEGAR
Dilator set consisting of:
14 Dilators,
1 Rack for dilators (4 - 12 mm)
1 Rack for Dilators (13 - 17 mm)
1 Metal case only,
with hinged lid, stainless 200 X 100 X 35 mm

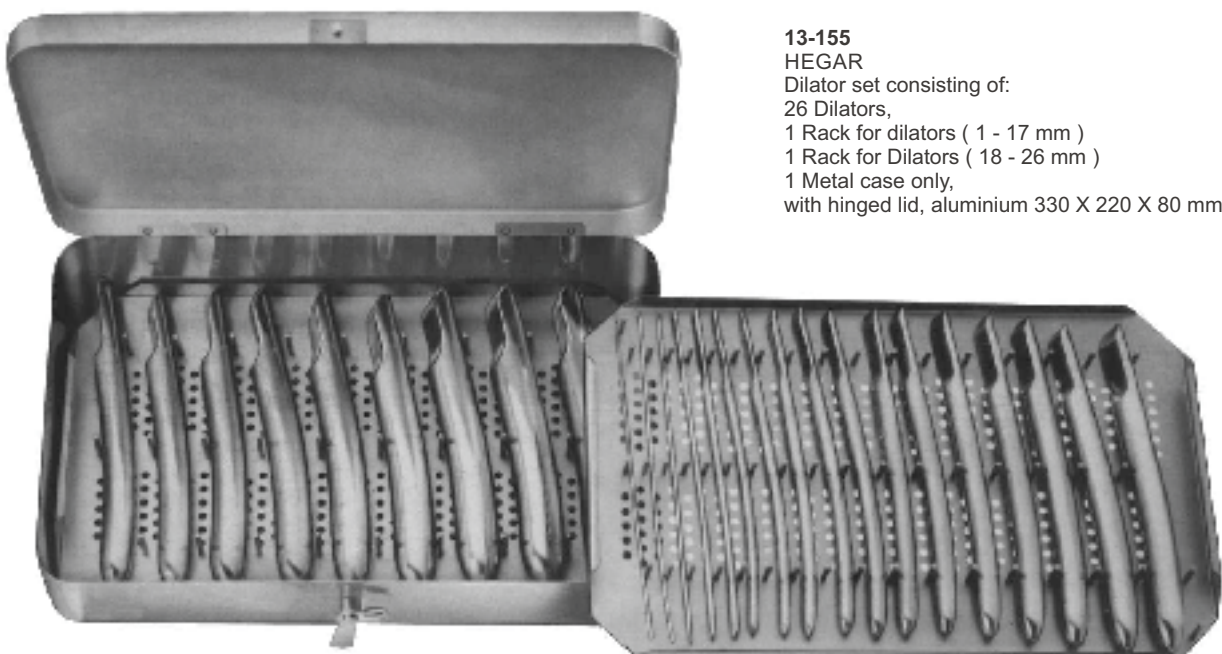

13-155
HEGAR
Dilator set consisting of:
26 Dilators,
1 Rack for dilators (1 - 17 mm)
1 Rack for Dilators (18 - 26 mm)
1 Metal case only,
with hinged lid, aluminium 330 X 220 X 80 mm

Endospecula For Cervix

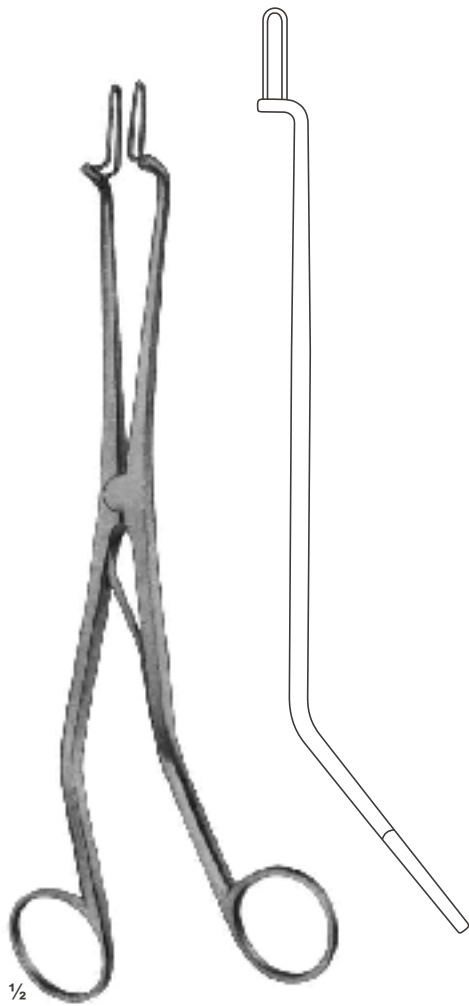

13-156
KOGAN
Endospecula for cervix
and urethra, without ratchet
240 mm

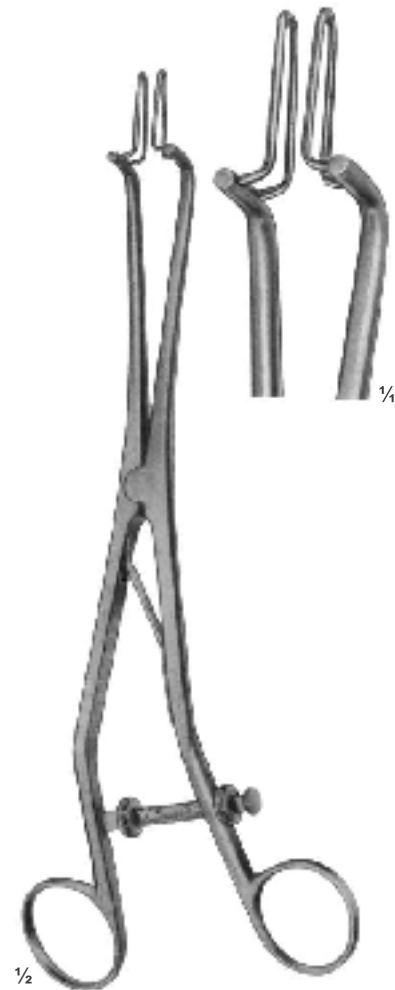

13-157
KOGAN
Endospecula for cervix
and urethra, with
scale-ratchet and fixing screws
240 mm

Uterine Probes

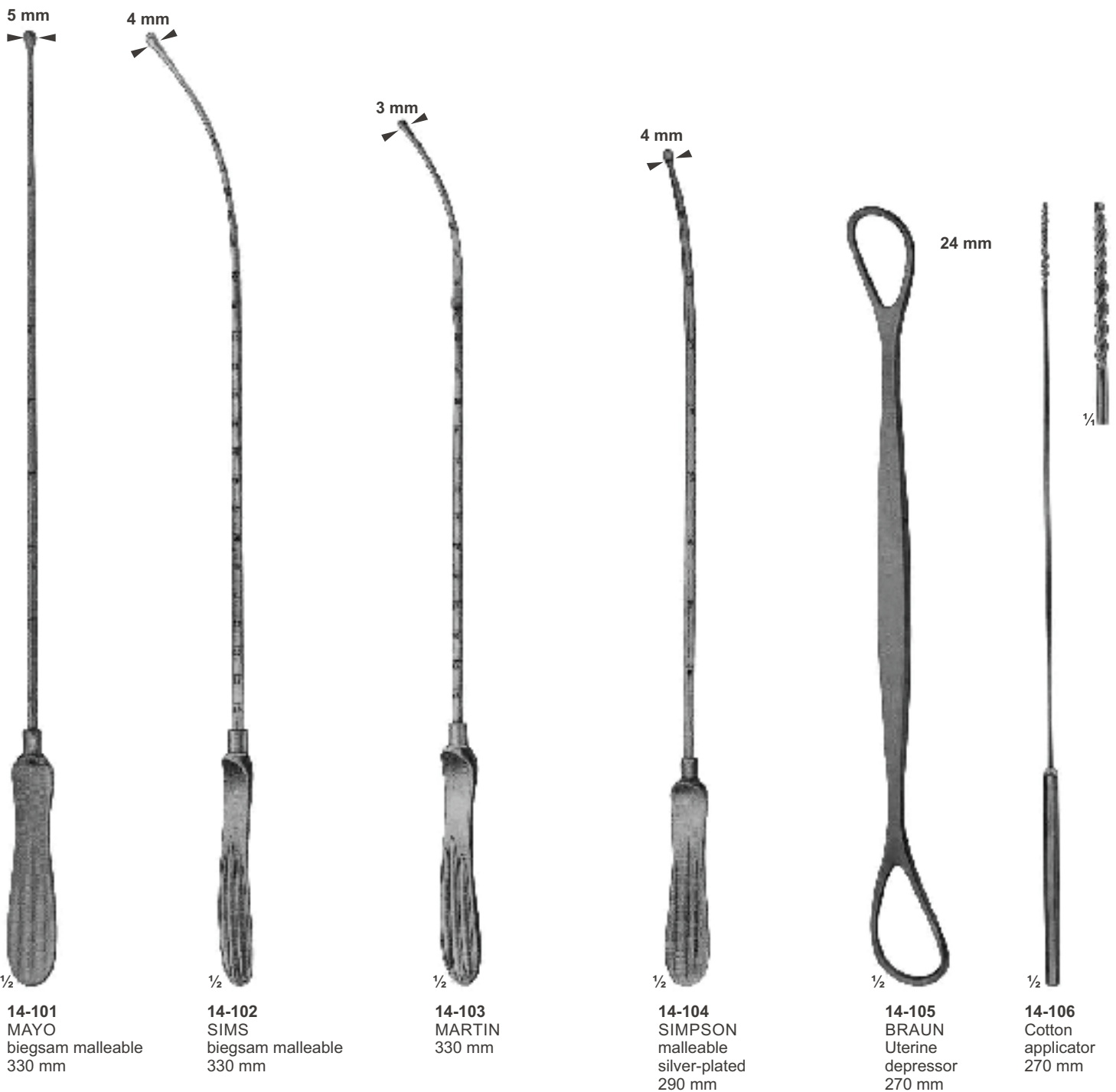

Uterine Dressing Forceps

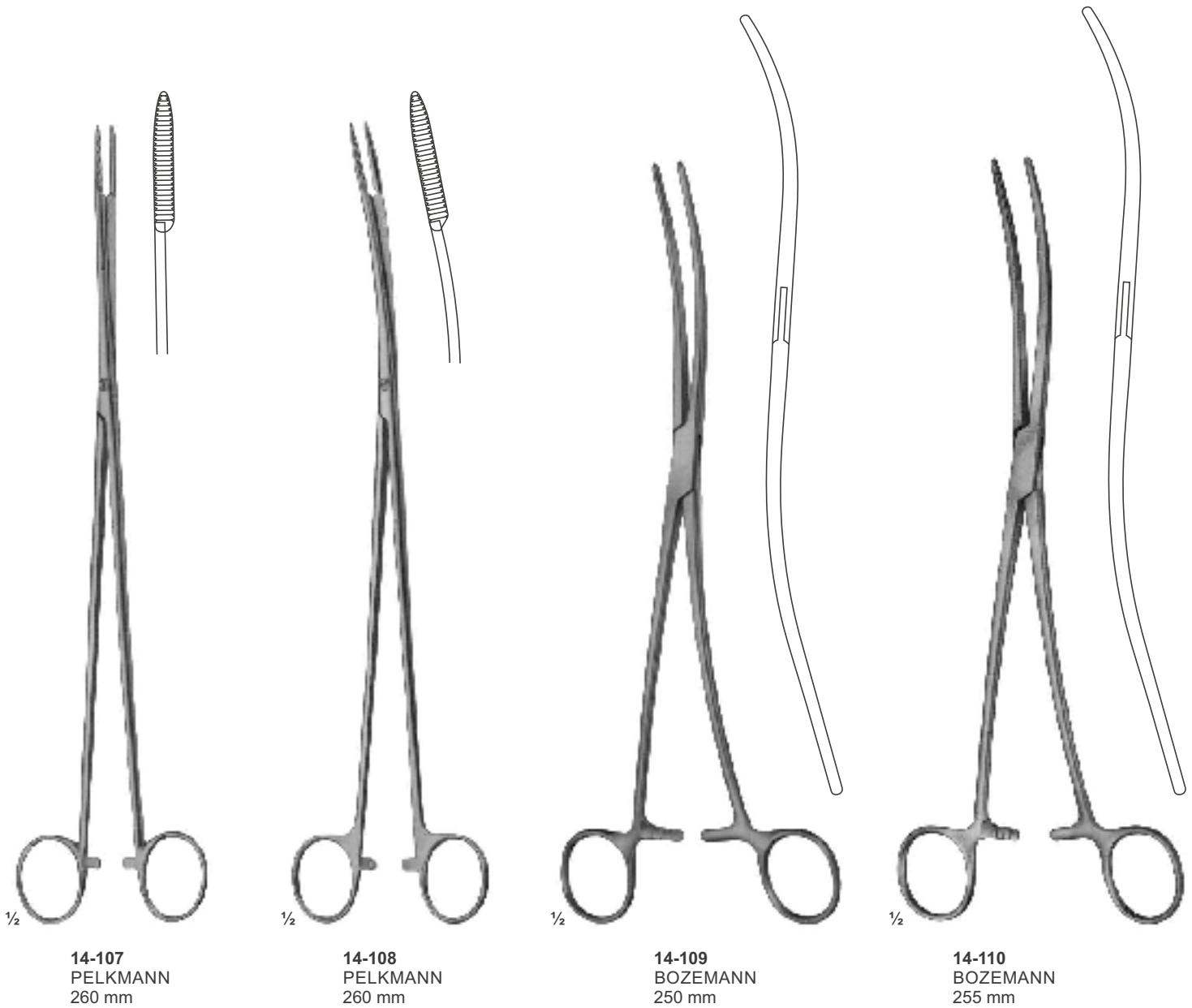

Jaws with longitudinal groove

Uterine Dressing Forceps

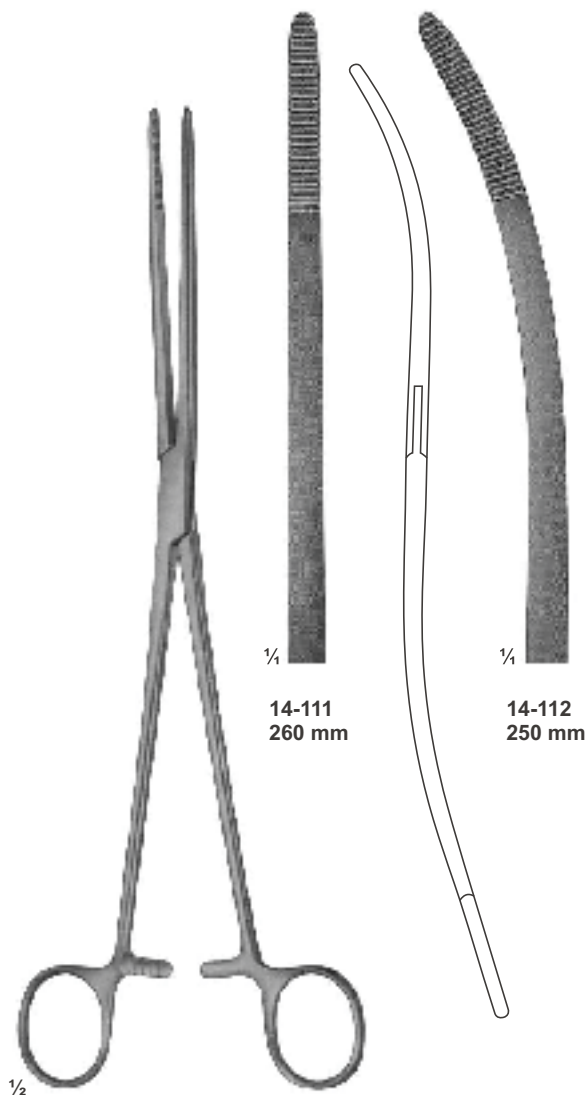

14-111 - 112
BOZEMANN

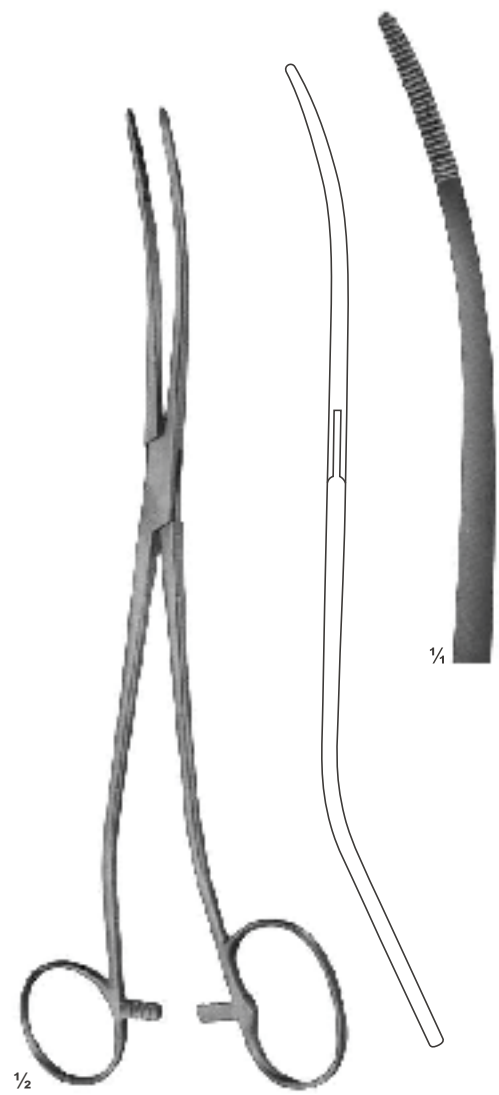

14-113
BOZEMANN-DOUGLAS
260 mm

Uterine Tenaculum Forceps

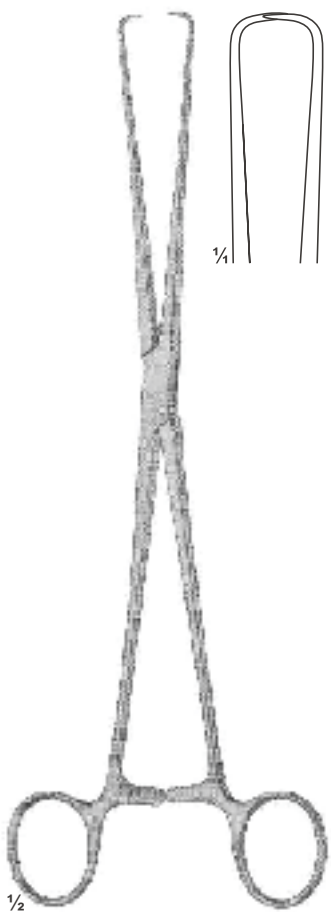

14-114
BRAUN
slender type
250 mm



14-115
SCHRODER
250 mm



14-116
POZZI
heavy type
255 mm

Uterine Tenaculum Forceps



14-117
265 mm

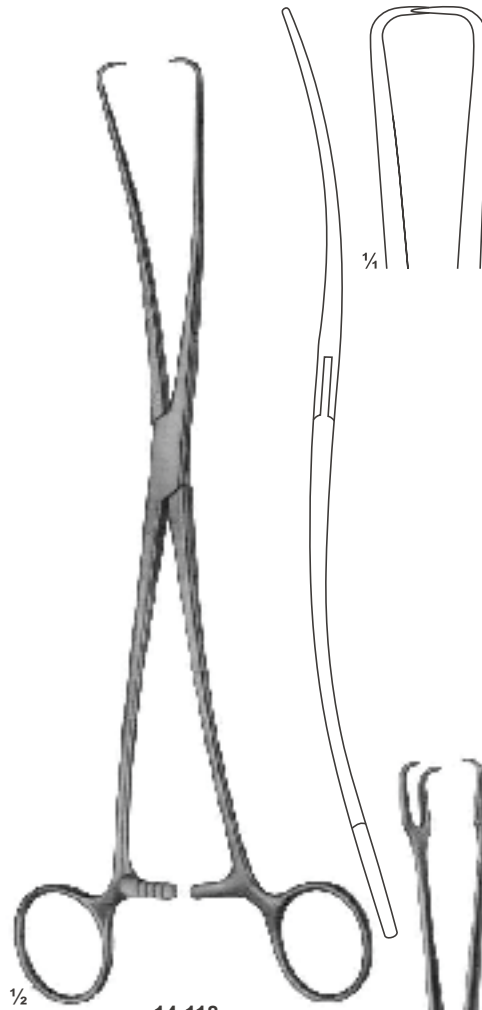
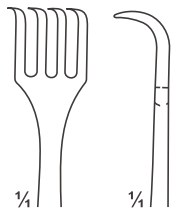

14-118
DUPLAY
250 mm

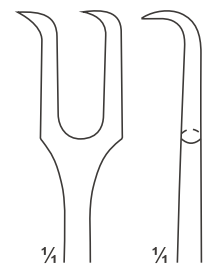

14-119
LAHEY
155 mm

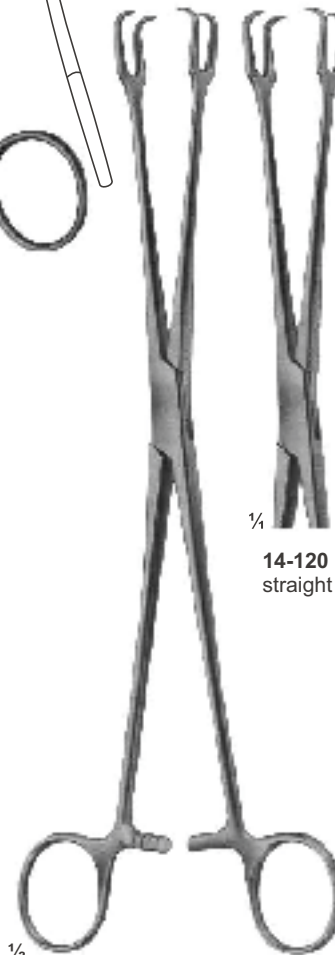

14-120 - 122
SCHRODER
250 mm



14-120
straight



14-121
curved
on flat



14-122
curved
sideways

Uterine Tenaculum Forceps

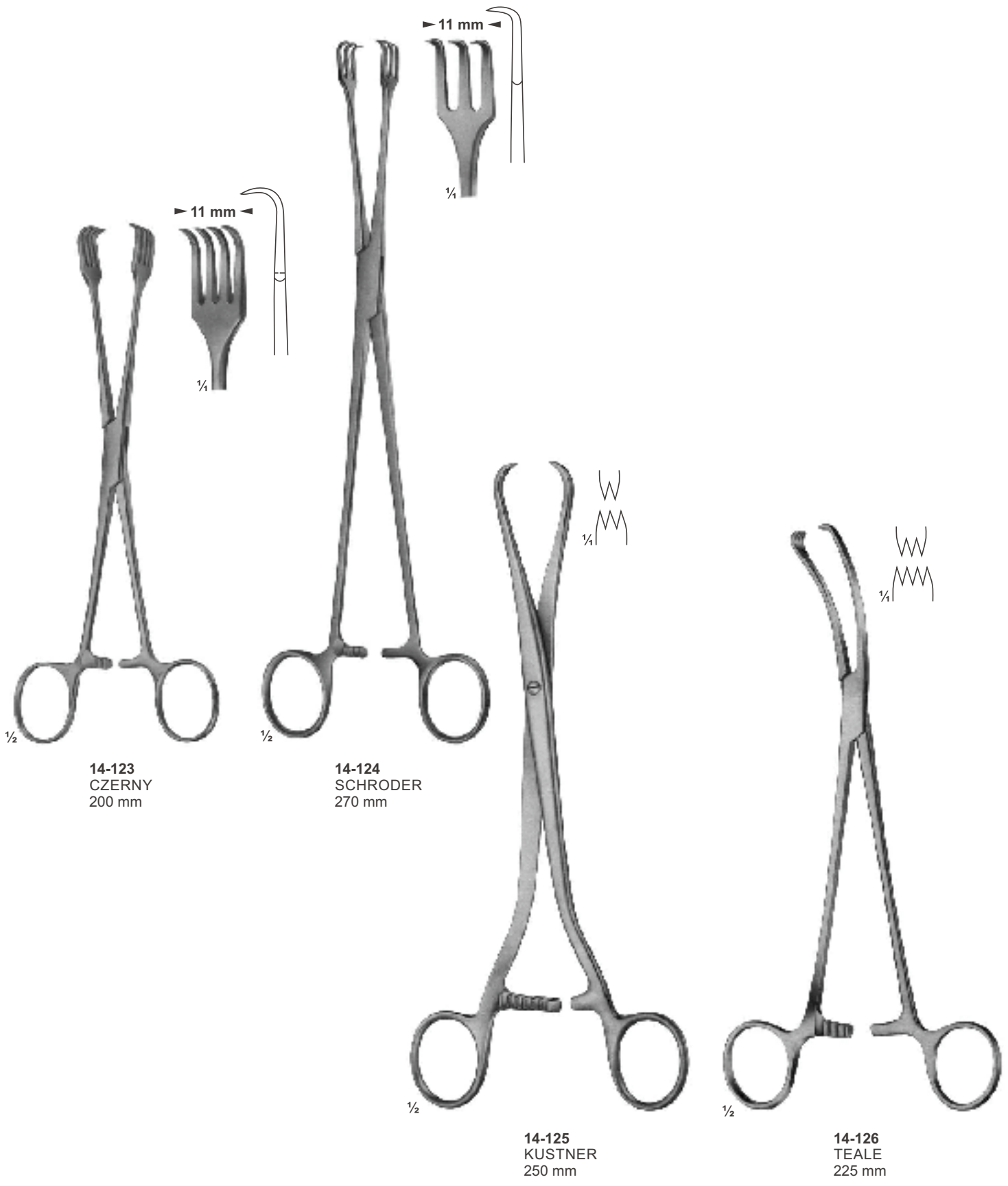

Uterine Tenaculum Forceps

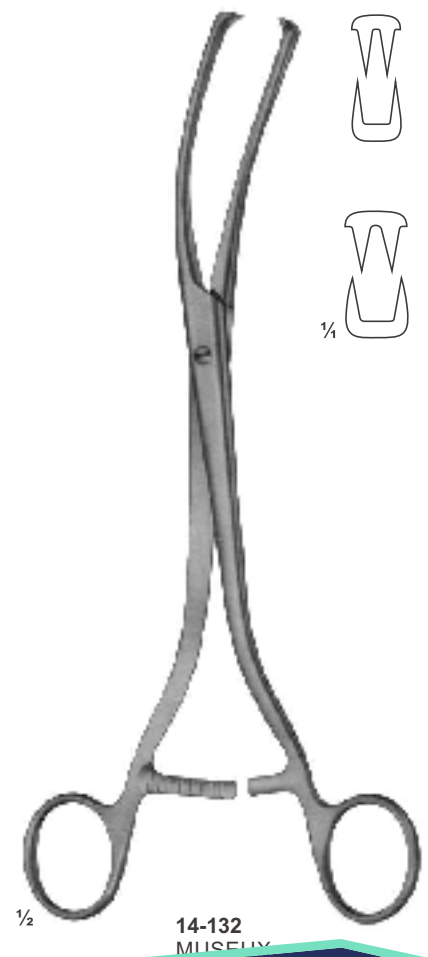
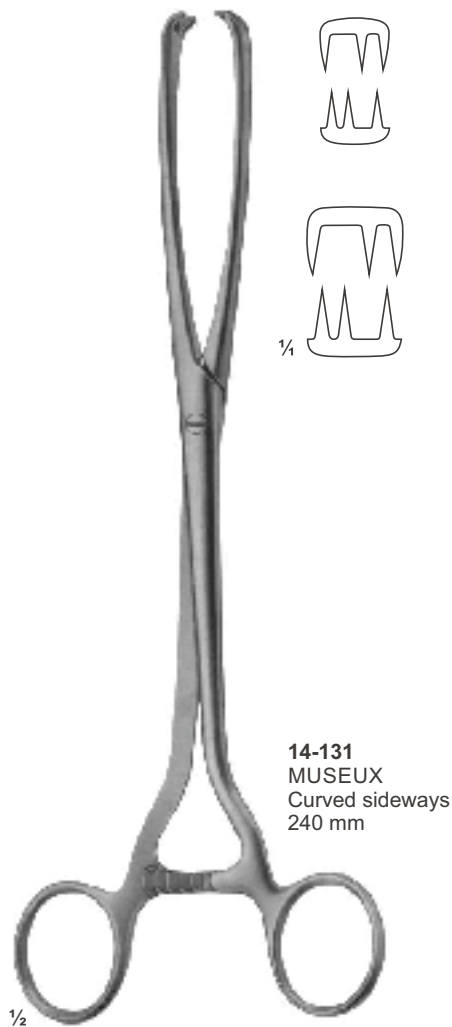
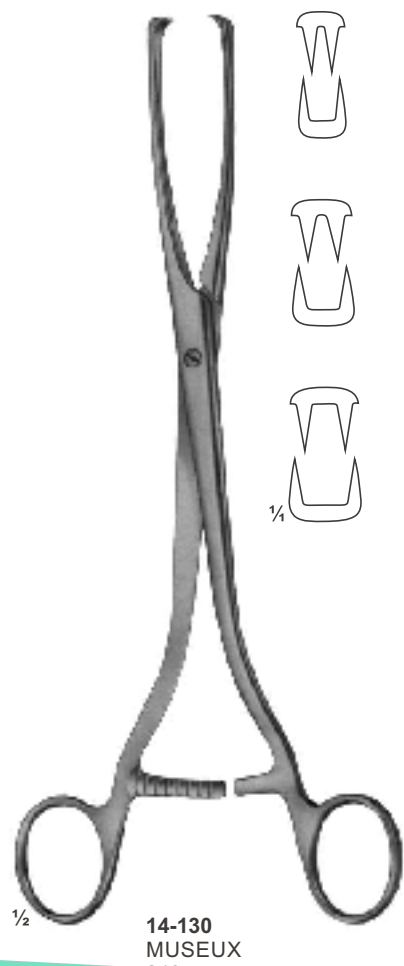

Polypus-and Ovum Forceps

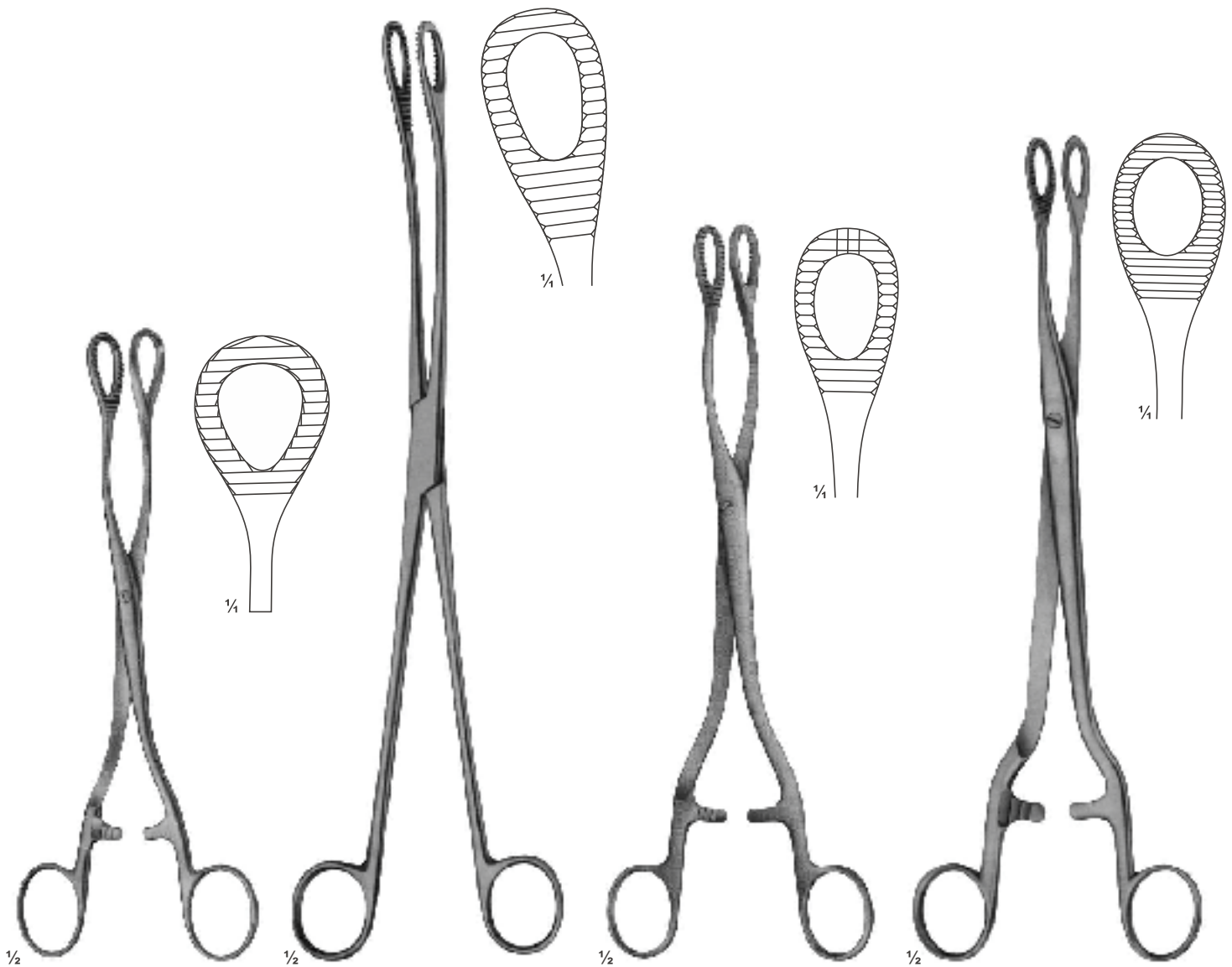

14-133
HEYWOOD-SMITH
200 mm

14-134
KELLY
320 mm

14-135
HEYWOOD-SMITH
250 mm

14-136
NOTO
280 mm

Polypus and Ovum Forceps



¼



¼

14-138



¼

14-139



¼



½

14-137
DOYEN
185 mm



½

14-138 - 139
250 mm 270 mm



½

14-140
BUMM
280 mm

Uterine Elevating Forceps

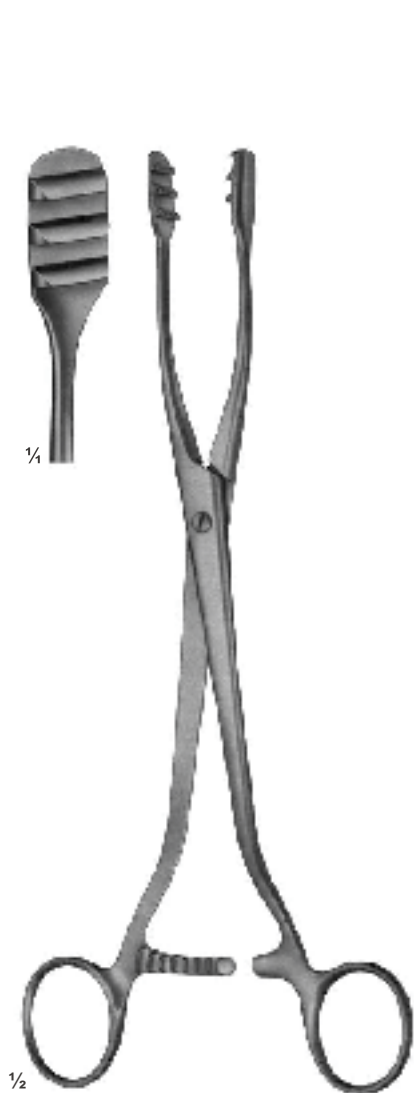

14-141
COLLIN
250 mm



14-142
COLLIN
285 mm



14-143
DARTIGUES
255 mm

Uterine Elevating Forceps



14-144
SOMMER
235 mm



14-145
STRASSMANN
260 mm

Uterine Elevating Forceps

With movable jaws



14-146
COLLIN
265 mm

With movable jaws



14-147
260 mm

Myoma Instruments



14-148
SEGOND
Myomatome
270 mm



14-149
DOYEN
Myoma screw
150 mm



14-150
DOYEN
Myoma screw
190 mm

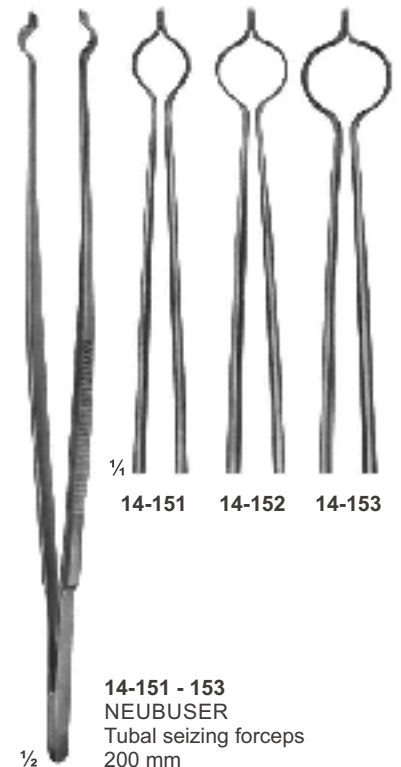

14-151 - 153
NEUBUSER
Tubal seizing forceps
200 mm



14-154
Splint guide
with thread



14-155
Splint guide with
round handle
180 mm



14-156
Angled glass rods
Set . 3 pieces

145 X 100 X 1.5 mm



14-157
Silicon operating pad
pre-cut



14-158
Polyaethylen splint material
soft-sterile

Biopsy Curettes

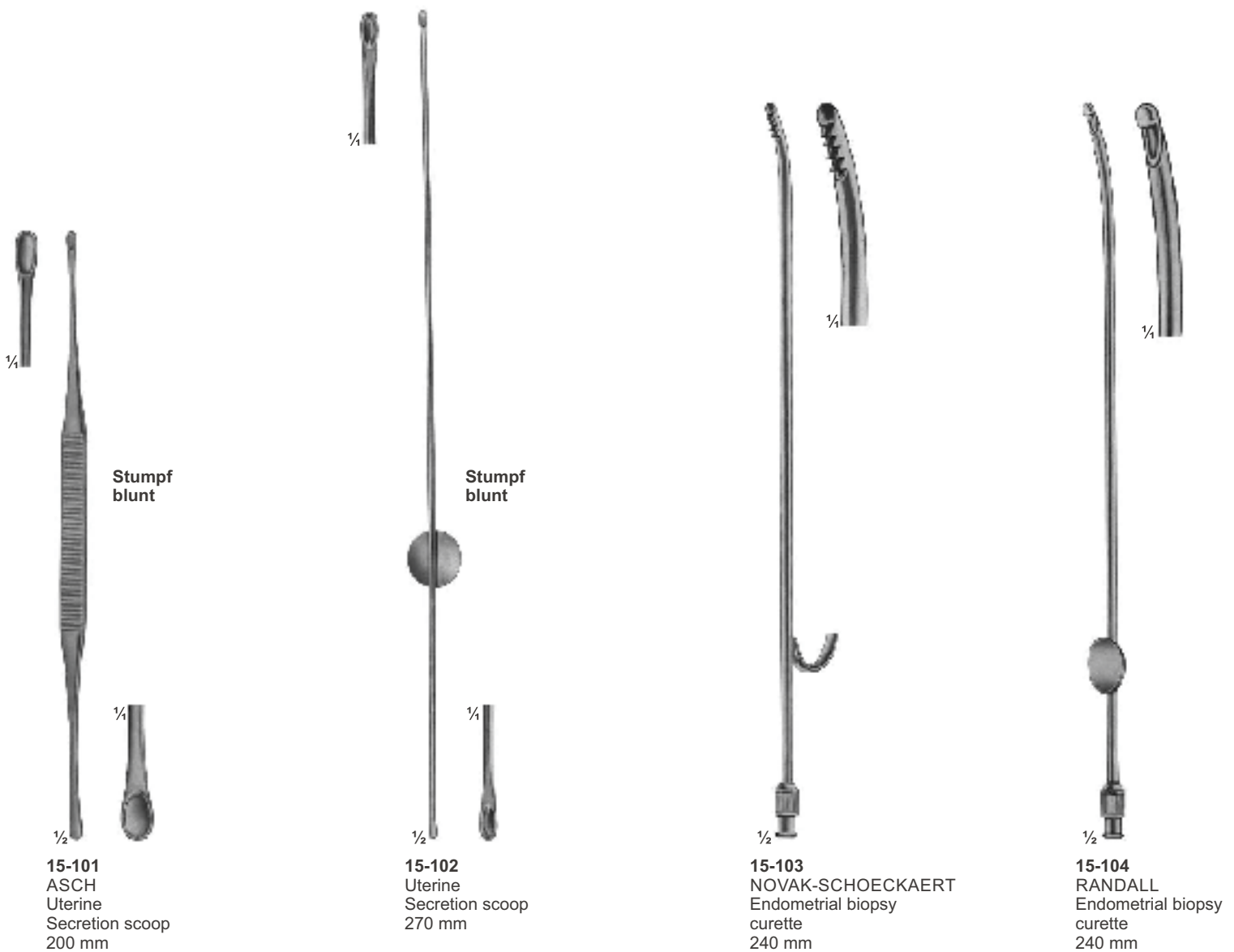

1/4

Stumpf blunt

1/4

1/2

15-101
ASCH
Uterine
Secretion scoop
200 mm

1/4

Stumpf blunt

1/4

1/2

15-102
Uterine
Secretion scoop
270 mm

1/4

1/2

15-103
NOVAK-SCHOECKAERT
Endometrial biopsy
curette
240 mm

1/4

1/2

15-104
RANDALL
Endometrial biopsy
curette
240 mm

Biopsy Forceps

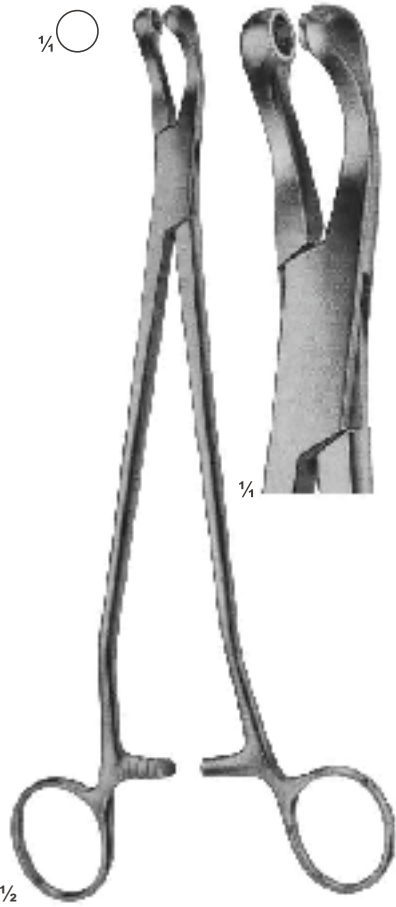

15-105
THOMS-GAYLOR
240 mm

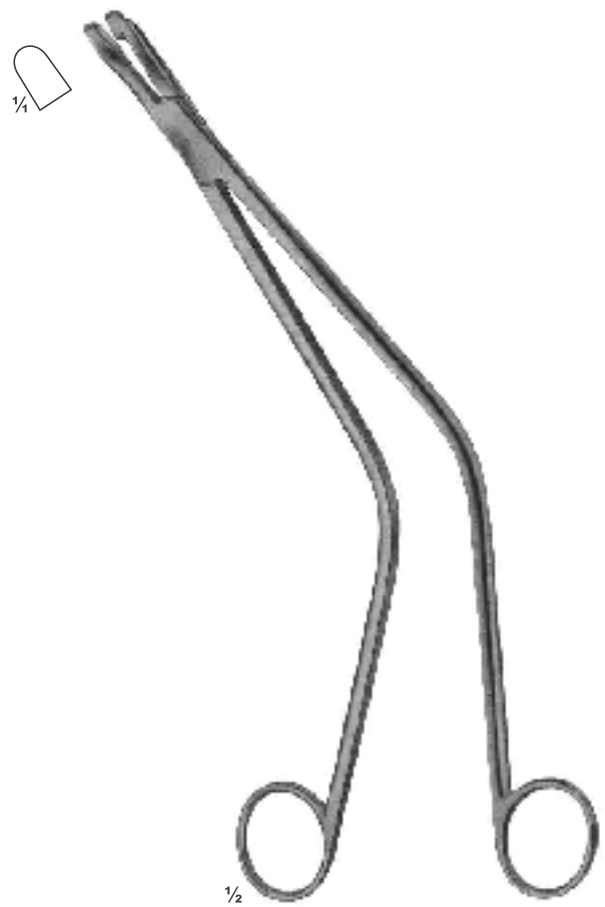

15-106
SCHUBERT
260 mm

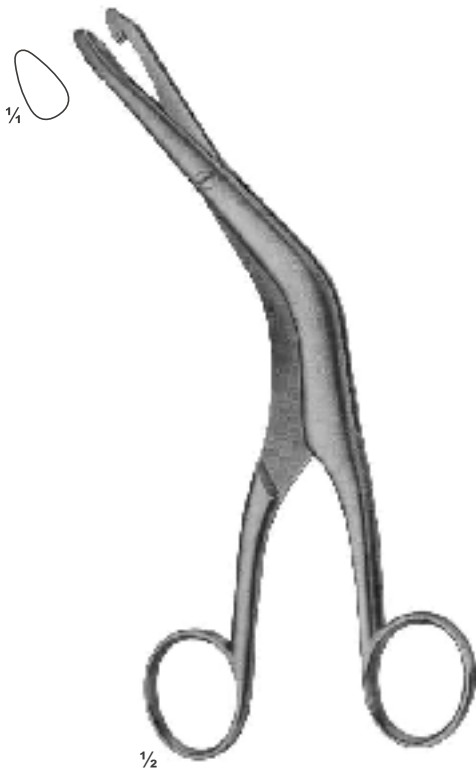

15-107
FAURE
210 mm

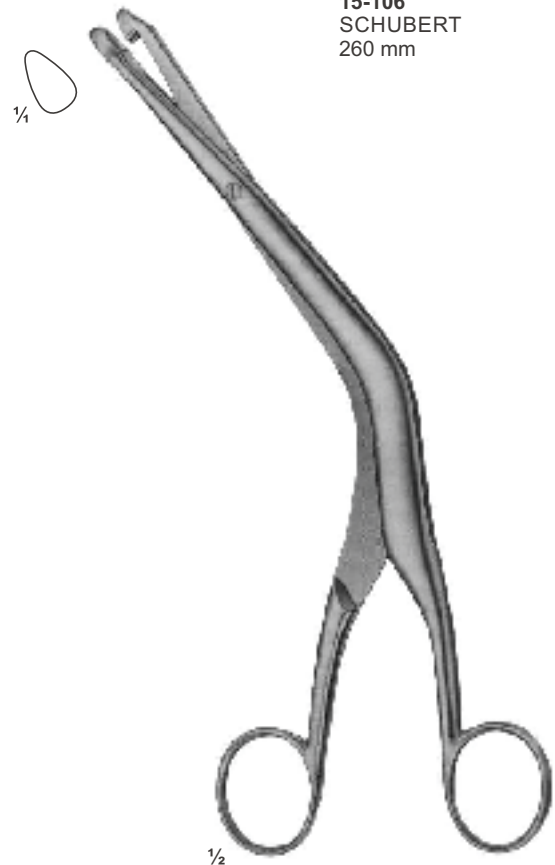

15-108
FAURE
240 mm

Biopsy Forceps

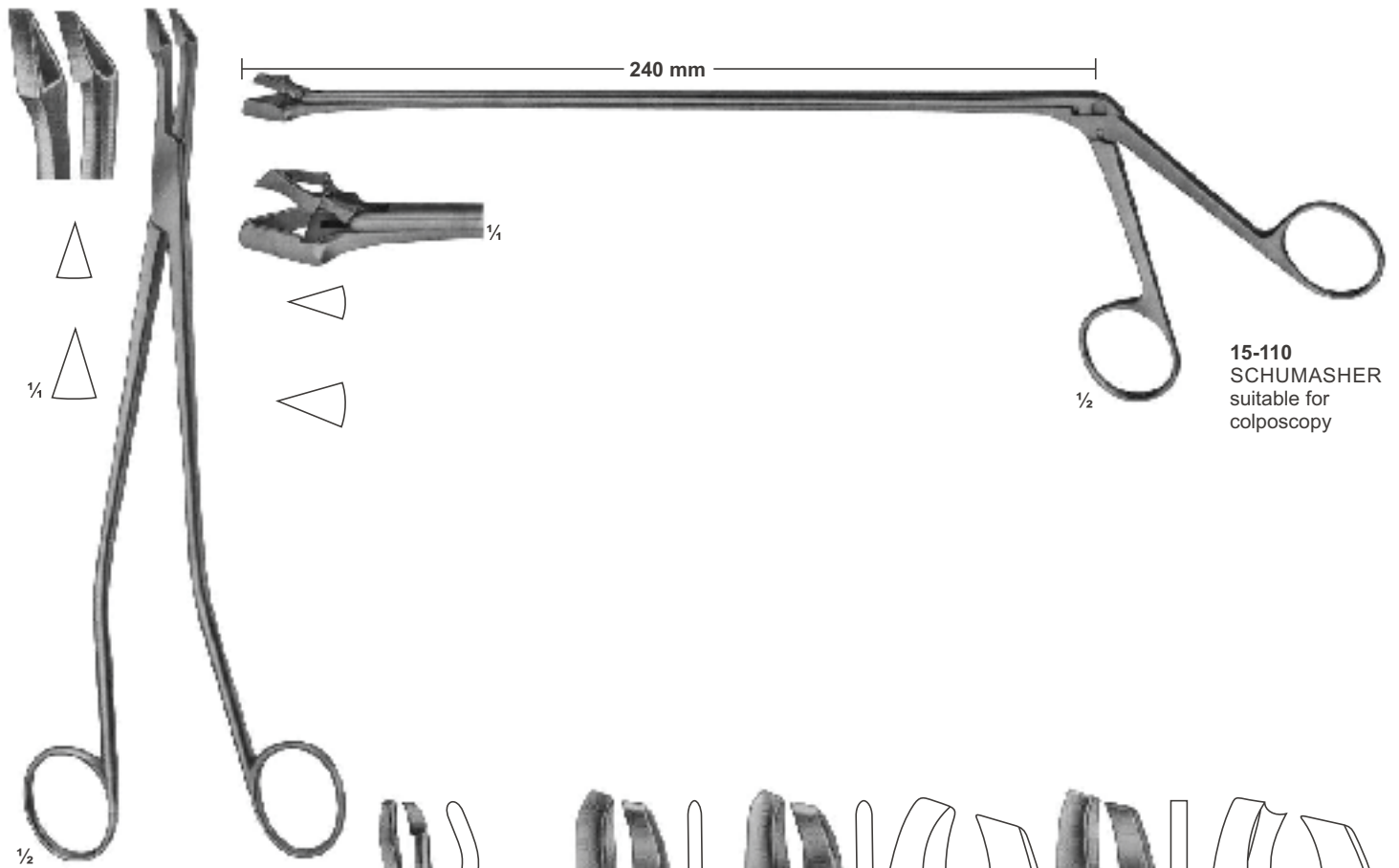

15-110
SCHUMASHER
suitable for
colposcopy

15-109
SCHUMASHER
240mm

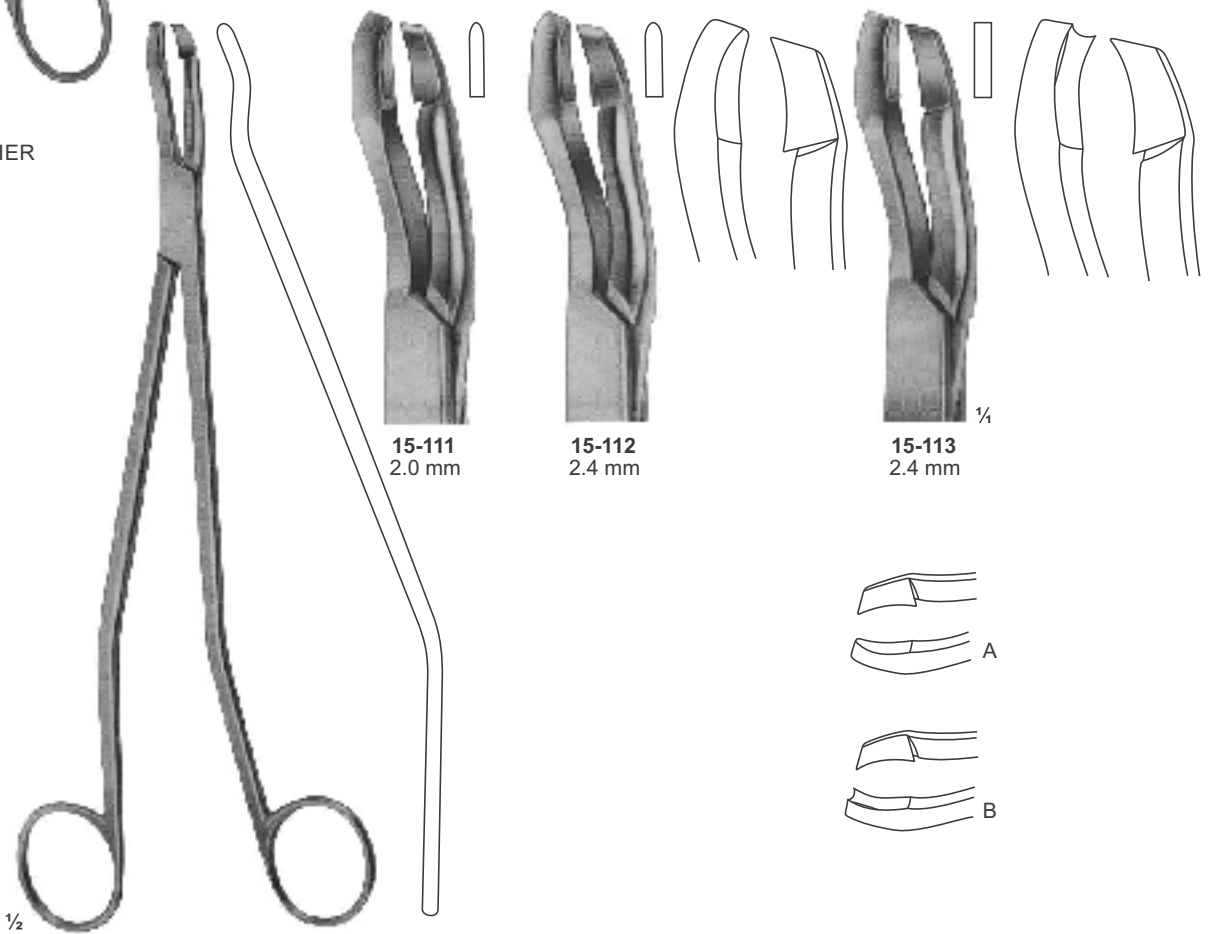

15-111
2.0 mm

15-112
2.4 mm

15-113
2.4 mm

15-111 - 113
SEIDL DBP
Biopsy forceps, bayonet shaped
for portio, vagina and vulva
240mm

Biopsy Forceps

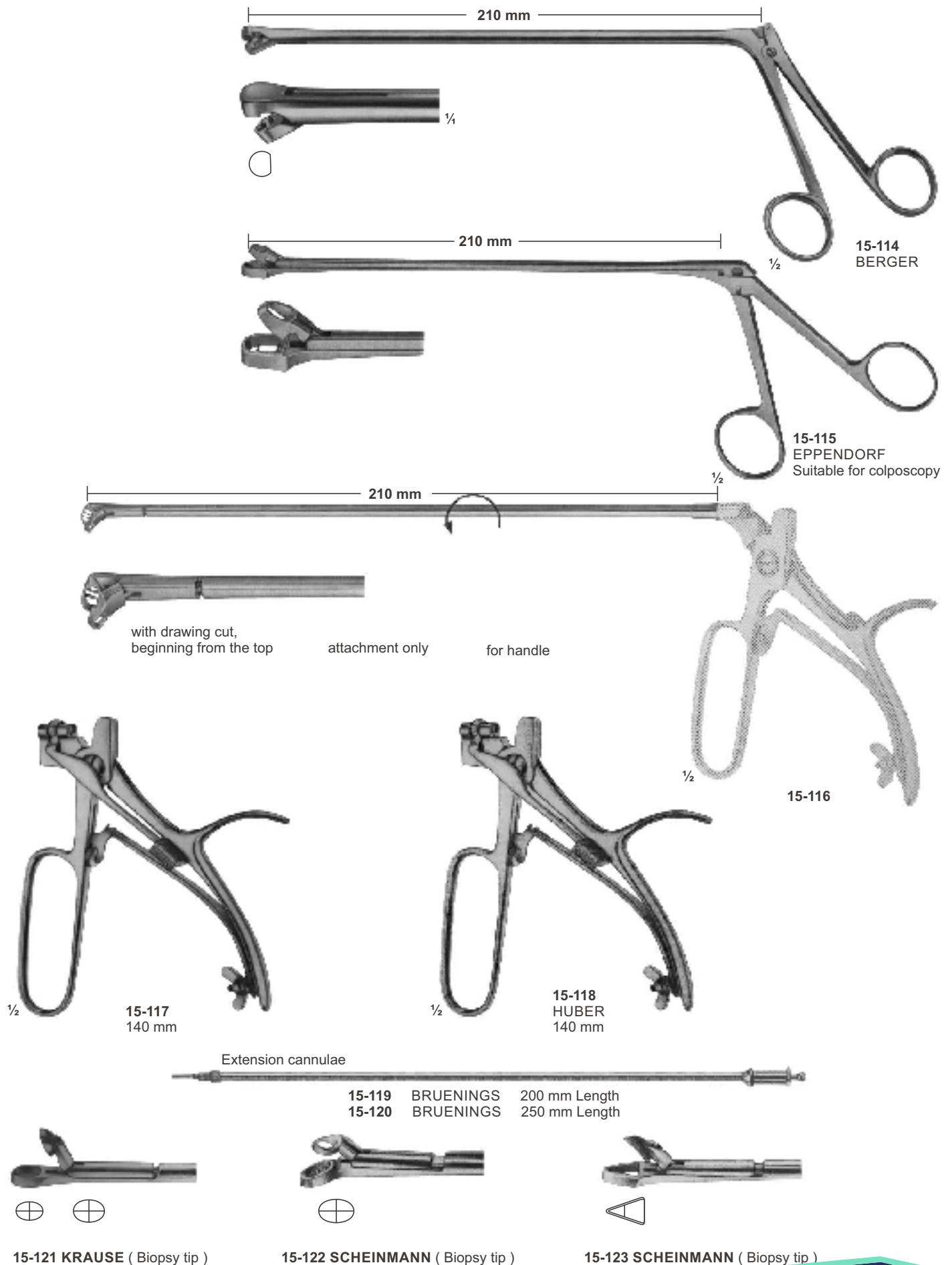

Uterine Scoops

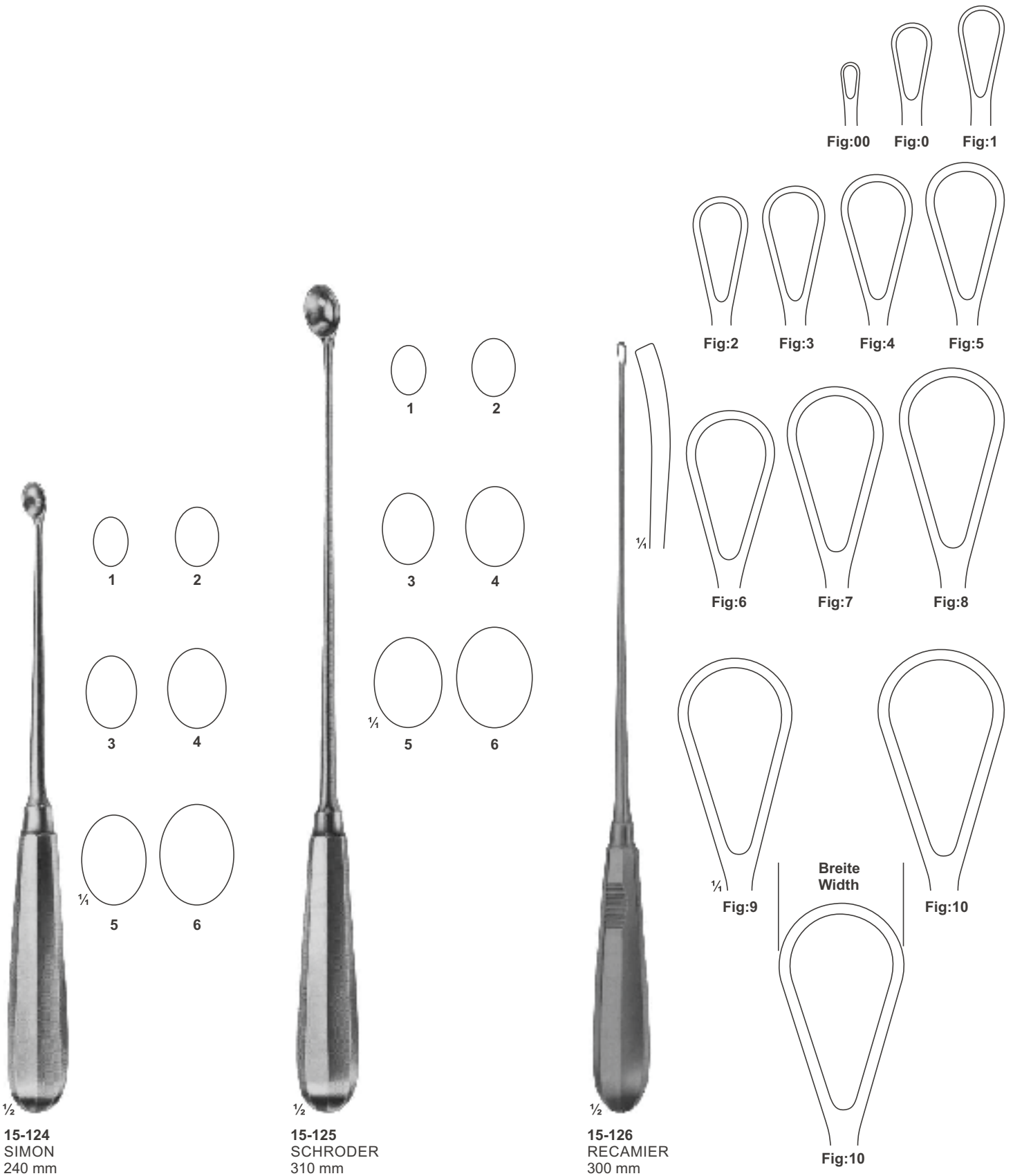

$\frac{1}{2}$
15-124
SIMON
240 mm

$\frac{1}{2}$
15-125
SCHRODER
310 mm

$\frac{1}{2}$
15-126
RECAMIER
300 mm

Uterine Curettes

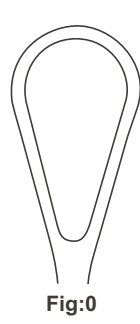

Fig:0

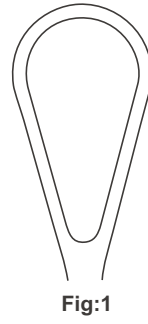

Fig:1

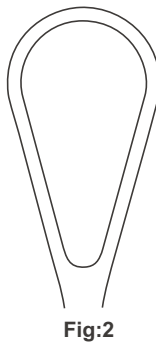

Fig:2

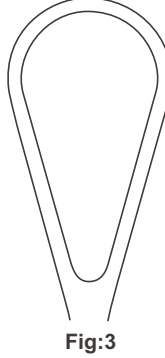

Fig:3



Fig:1



Fig:2



Fig:3



Fig:4

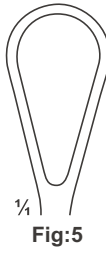

Fig:5

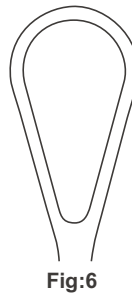

Fig:6

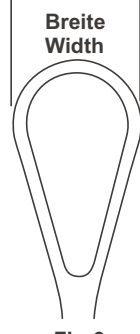

Fig:6



15-128
BUMM
blunt-malleable
290 mm

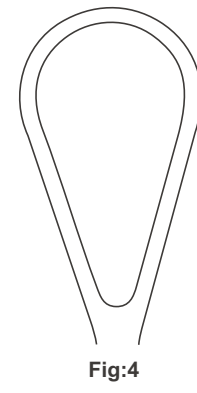

Fig:4

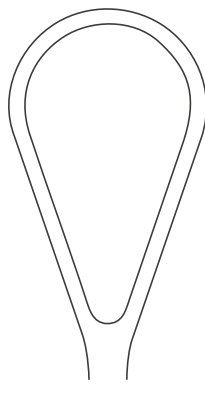

Fig:5

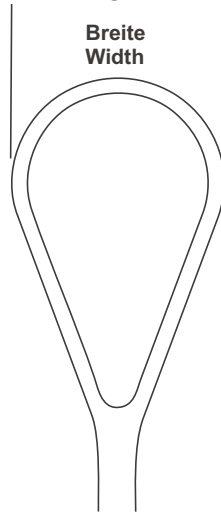
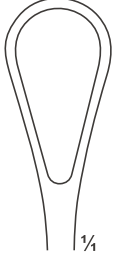

Fig:6



15-129
BLAKE
275 mm



Stumpf
blunt



1/4



15-127
SIMS
255 mm

Placenta-and Ovum Currettes

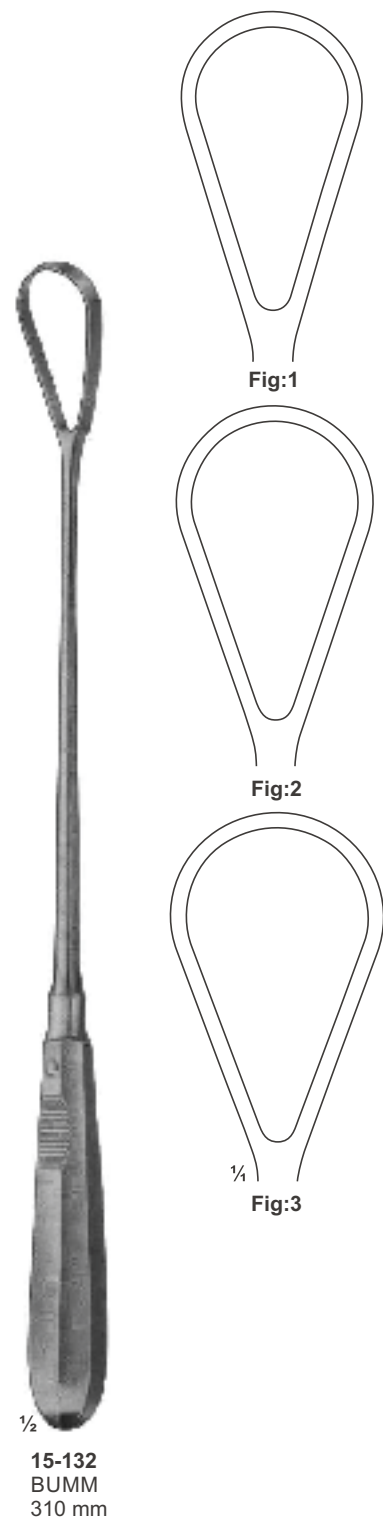
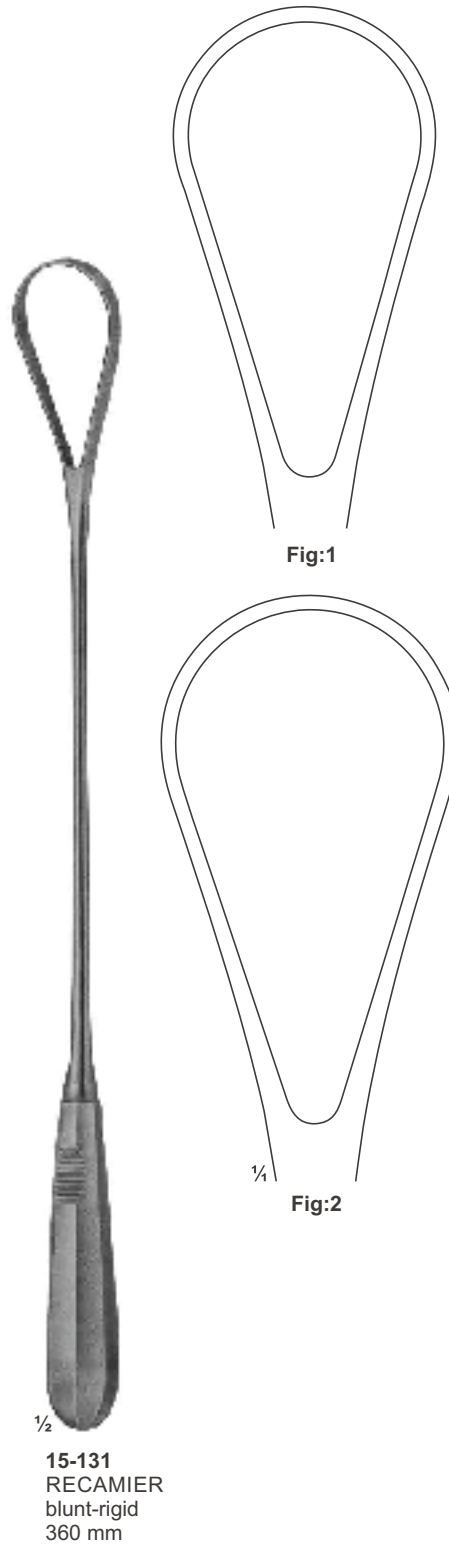

Vacuum Currettes

15-133 - 138

Suction currettes, stainless steel, fitting hose connection.

Working tips are smoothly rounded of, therefore no danger of perforation.

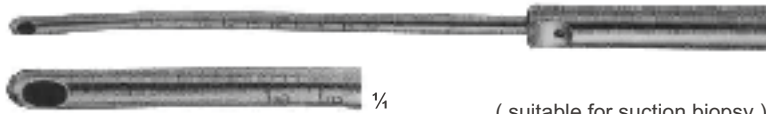

(suitable for suction biopsy)

15-133: diam 4 mm

15-134: diam 6 mm

15-135: diam 8 mm

15-136: diam 10 mm

15-137: diam 12 mm

15-138: diam 14 mm

15-139

Hose connection inside diam. 11 mm curved stainless steel.



15-140

The new connection between suction curette and hose connection, Guarantees quick changing and free turning of the suction currettes on the hose connection.

15-141

Transparent suction hose 1.8 mm long, inside diam 11 mm, outside diam 16.5 mm can be sterilized in an autoclave at 1 bar overpressure (120 C)



15-142

Strainer for tissues, plastic, for single use only, to be used for histopathological examination.

Gynaecological Instruments



15-145
SCHULZE
Salpingograph, for utero-salpingography
in wooden case, consisting of:
Manometer, Connection, Uterine canulla
with tap, Cone S.M.L.,
Record Syringe 10 cc, Luer lock mount.

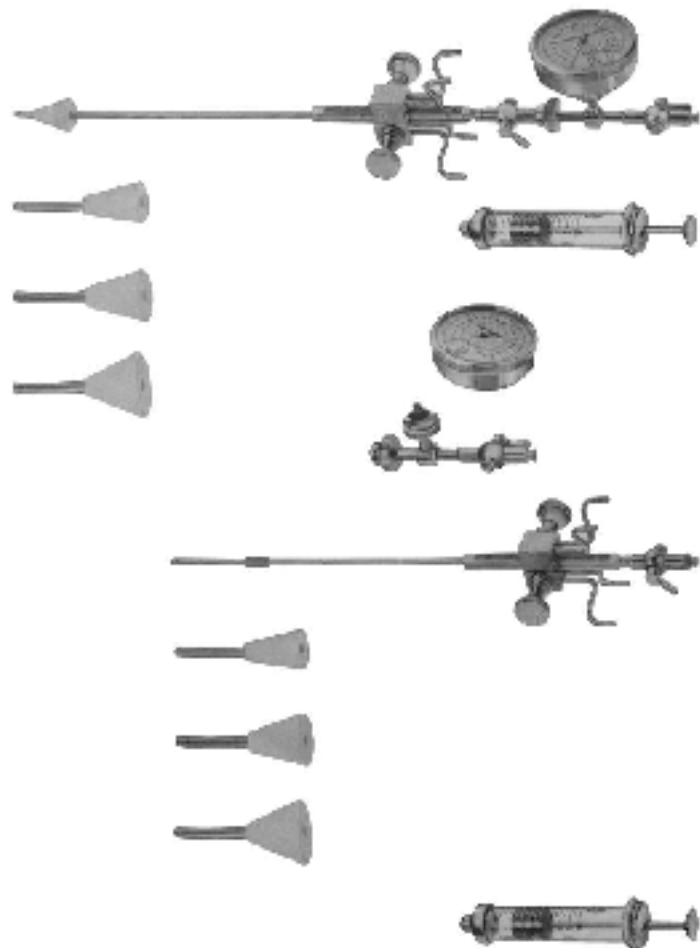

15-146
SCHULZE
Salpingograph, equipment
without manometer.



Obstetrics-Pelvimeters

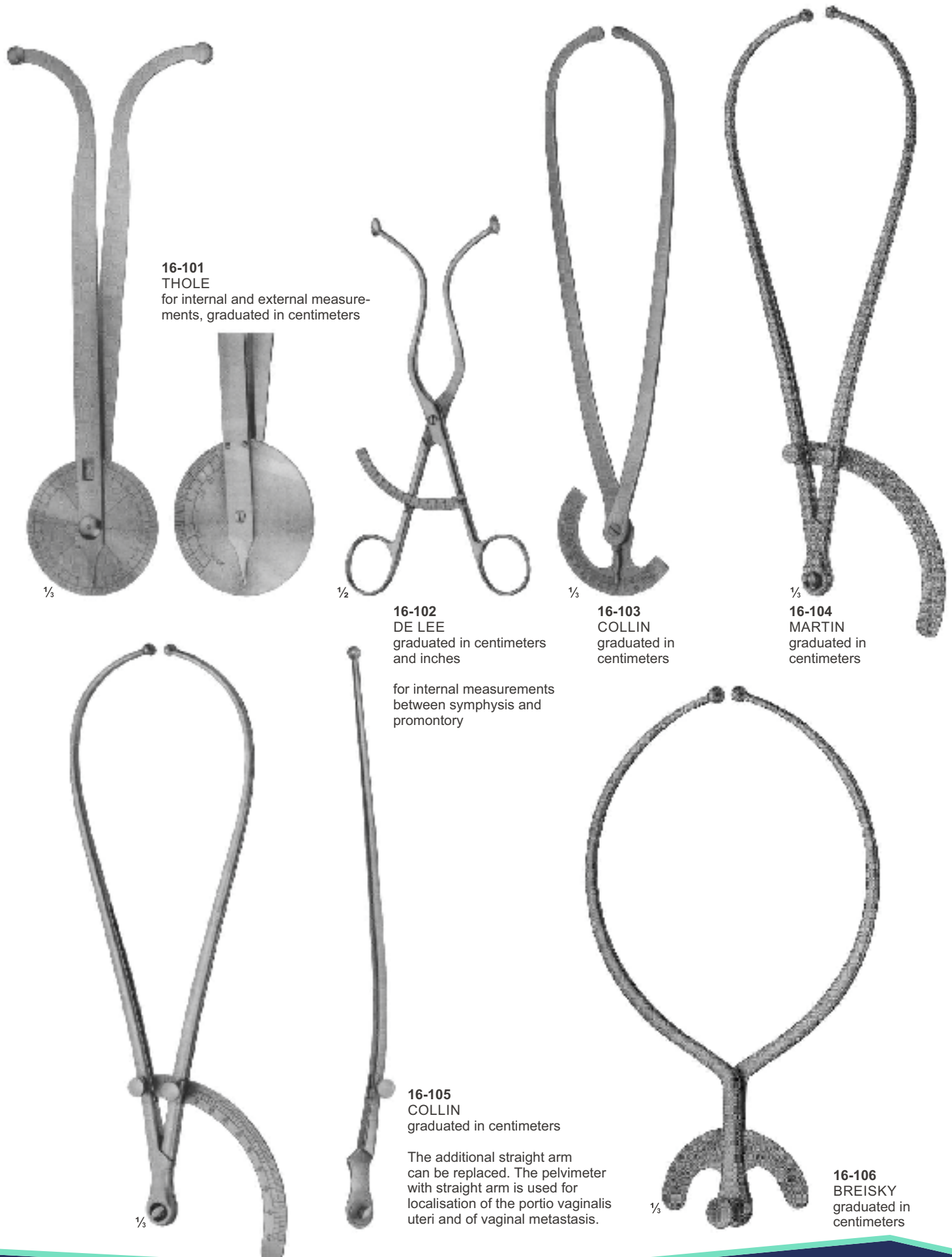

16-101
THOLE
for internal and external measurements, graduated in centimeters

16-102
DE LEE
graduated in centimeters and inches

16-103
COLLIN
graduated in centimeters

16-104
MARTIN
graduated in centimeters

for internal measurements between symphysis and promontory

16-105
COLLIN
graduated in centimeters

The additional straight arm can be replaced. The pelvimeter with straight arm is used for localisation of the portio vaginalis uteri and of vaginal metastasis.

16-106
BREISKY
graduated in centimeters

Obstetrics-Pelvimeters

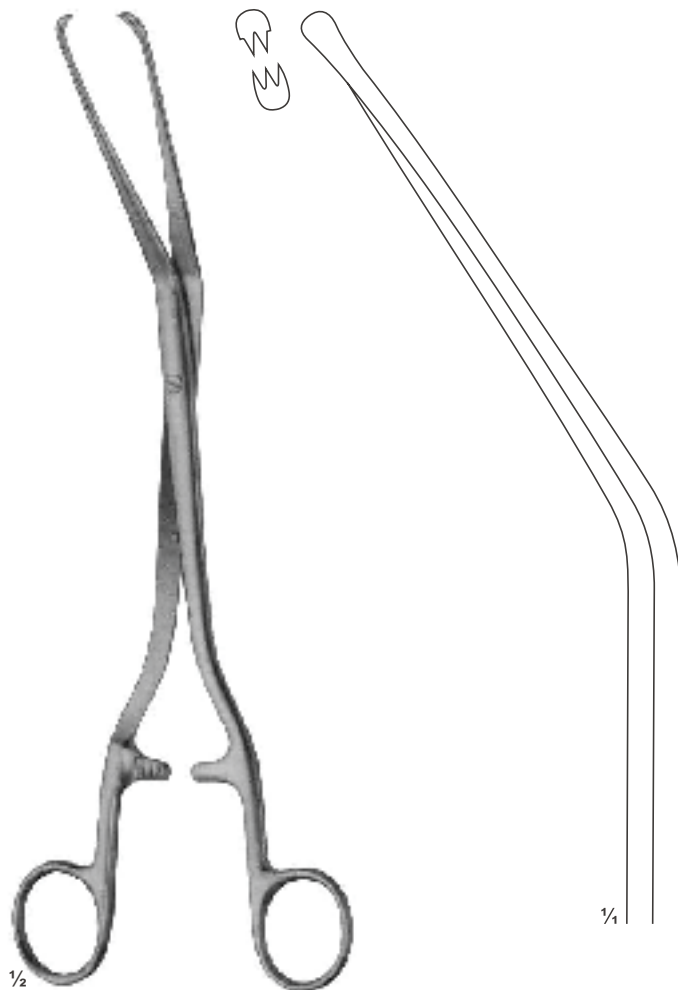

1/2
16-107
HERFF
puncturing forceps
225 mm



1/2
16-108
IOWA
puncturing forceps
260 mm

Scissors of Obstetrics, Umbilical cord clamp



16-109
SCHUMACHER
Umbilical cord
scissors
155 mm



16-110
Umbilical cord
scissors
105 mm

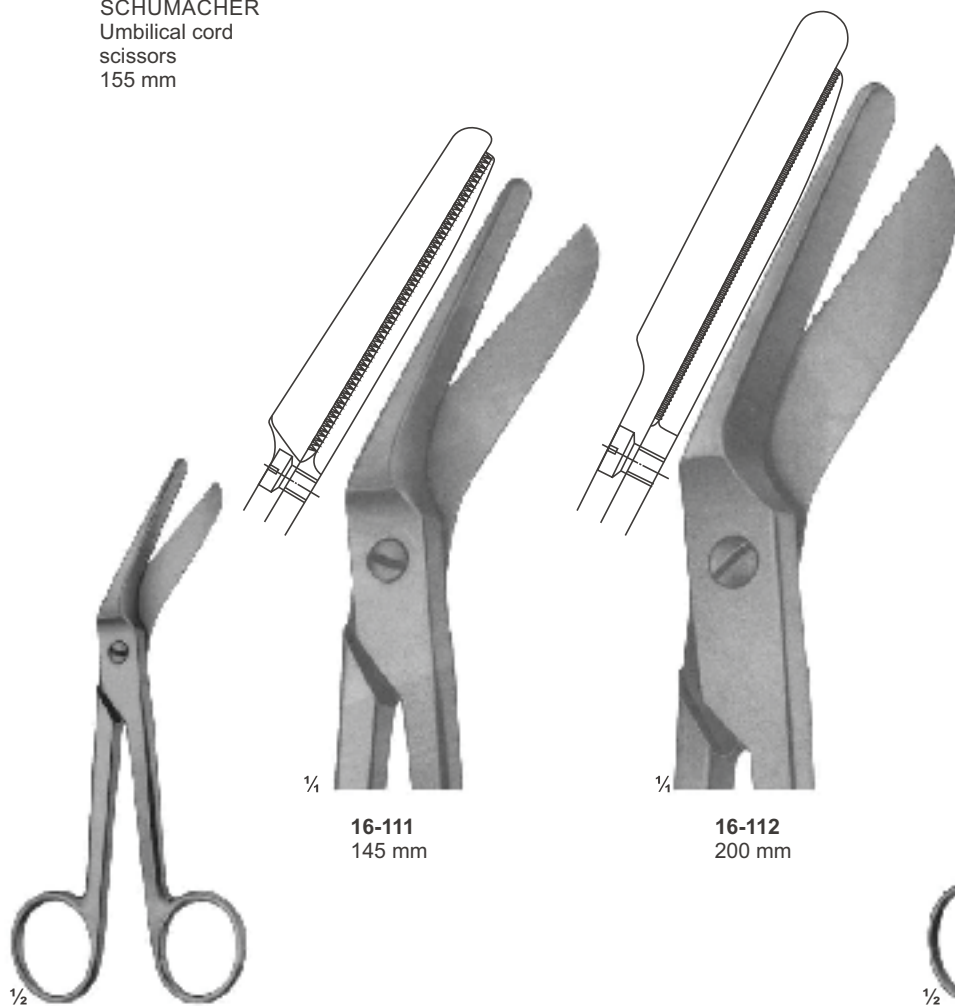

16-111
145 mm

16-112
200 mm

16-111 - 112
BRAUN-STADLER
Episiotomy Scissors

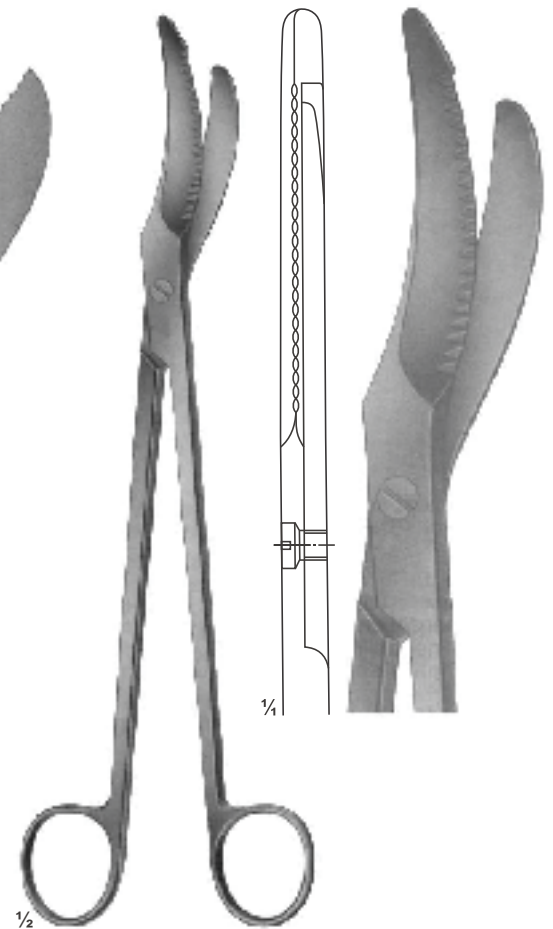

16-113
Episiotomy Scissors
240 mm

Obstetrics Forceps



16-114
355 mm



16-115
400 mm



16-116
SIMPSON-BRAUN
305mm

Obstetrics Forceps



16-117
SIMPSON-BRAUN
305mm



16-118
SIMPSON
235mm



16-119
WRIGLEY
250 mm

Obstetrics Forceps



$\frac{1}{2}$

16-120
GREEN-ARMYTAGE
Caesarean section haemostatic
forceps, for edges of the transverse
incision in the lower segment
220 mm

$\frac{1}{2}$

16-121
WILLETT
Scalpel Flap forceps
185 mm

$\frac{1}{2}$

16-122
GAUSS
Scalpel Flap forceps
260 mm

Obstetrics-Placenta and Ovum Forceps

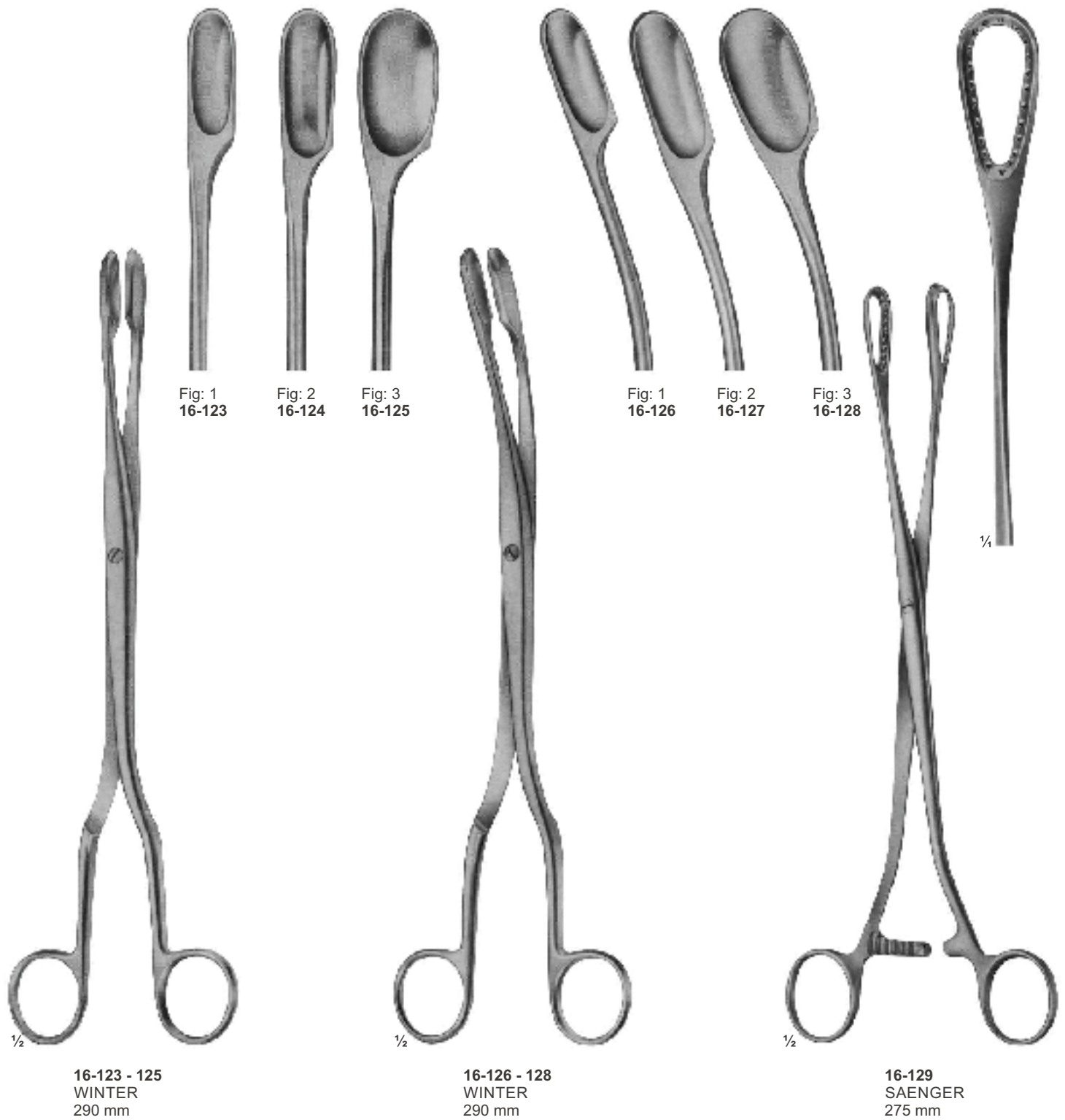

Obstetrics-Placenta and Ovum Forceps

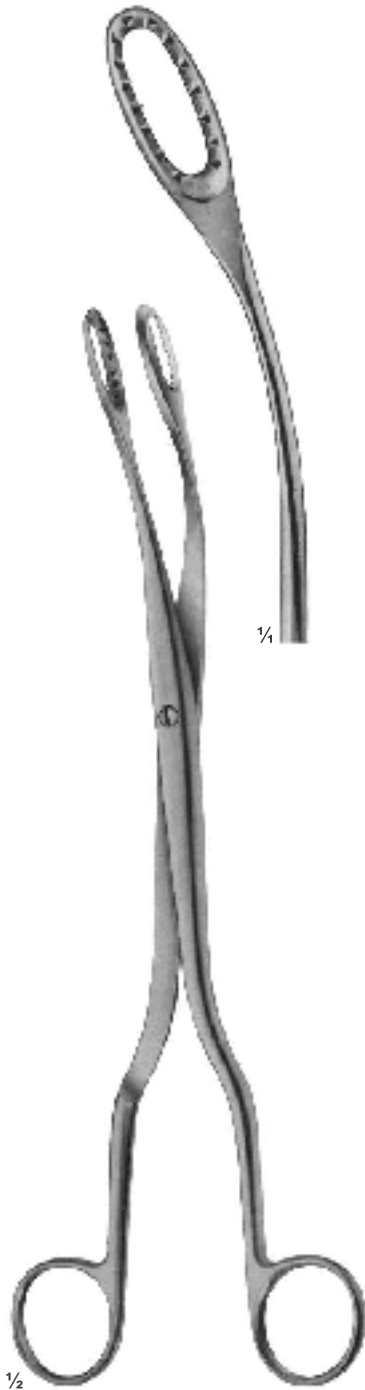

16-130
SAENGER
285 mm

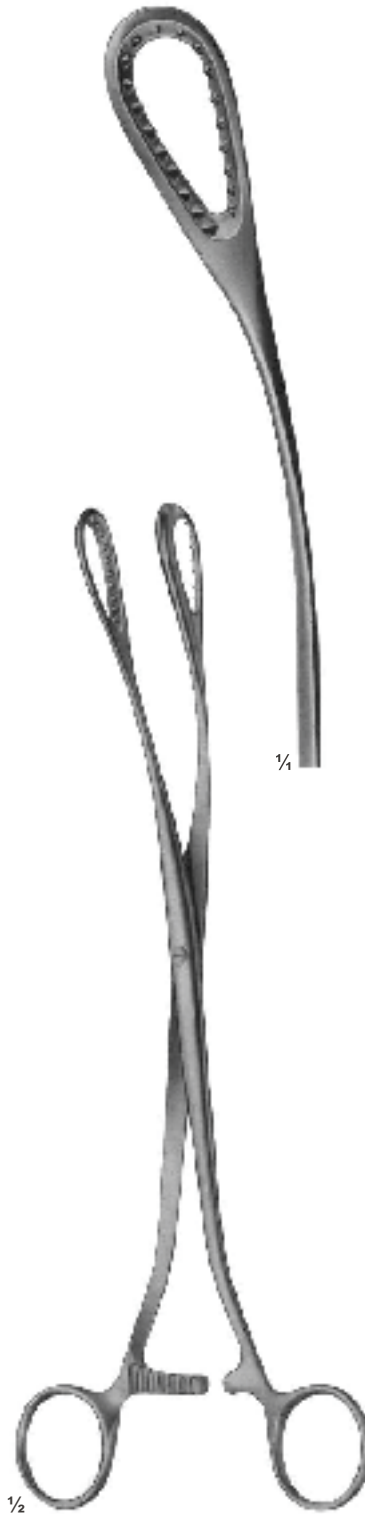

16-131
SAENGER
285 mm

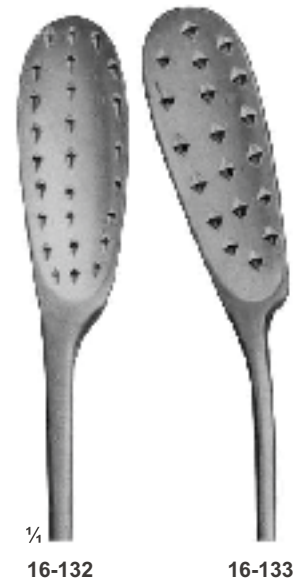

16-132 - 133
LEWKOWIZ
245 mm

Obstetrics-Placenta, Ovum and Cranioclast, Basiotribe Forceps

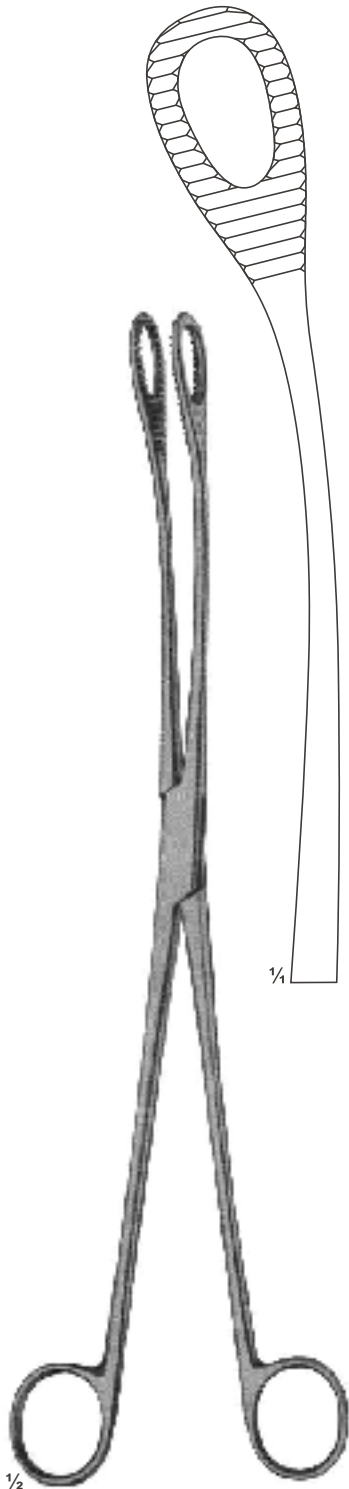

16-134
KELLY
320mm



16-135
SMELLIE
Perforator
270mm



16-136
BRAUN
Cranioclast
420mm

Tracheal Tubes with inner tubes



1/2

16-137
UECKERMANN-DENKER
Cryothyrotomy trocar
with silver cannula
130mm

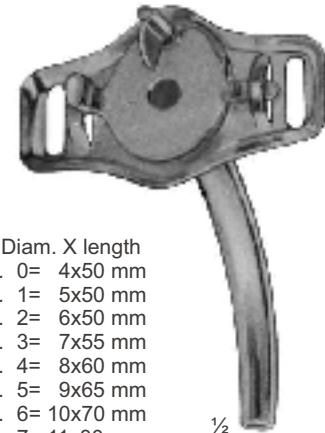

1/2

Diam. X length
16-138 Fig. 0= 4x50 mm
16-139 Fig. 1= 5x50 mm
16-140 Fig. 2= 6x50 mm
16-141 Fig. 3= 7x55 mm
16-142 Fig. 4= 8x60 mm
16-143 Fig. 5= 9x65 mm
16-144 Fig. 6= 10x70 mm
16-145 Fig. 7= 11x80 mm
16-146 Fig. 8= 12x85 mm
16-147 Fig. 9= 13x90 mm
16-148 Fig. 10=14x90 mm

16-138 - 148
LUER
German silver



1/2

16-149 - 158
JACKSON
German Silver

Diam. X length
16-149 Fig. 0= 4x50 mm
16-150 Fig. 1= 5x58 mm
16-151 Fig. 2= 6x58 mm
16-152 Fig. 3= 7x70 mm
16-153 Fig. 4= 8x78 mm
16-154 Fig. 5= 9x84 mm
16-155 Fig. 6= 10x84 mm
16-156 Fig. 7= 11x86 mm
16-157 Fig. 8= 12x88 mm
16-158 Fig. 9= 13x90 mm



1/2

Diam. X length
16-159 Fig. 1= 5x48 mm
16-160 Fig. 2= 6x58 mm
16-161 Fig. 3= 7x70 mm
16-162 Fig. 4= 8x78 mm
16-163 Fig. 5= 9x84 mm
16-164 Fig. 6= 10x84 mm
16-165 Fig. 7= 11x86 mm
16-166 Fig. 8= 12x88 mm
16-167 Fig. 9= 13x90 mm
16-168 Fig.10= 14x90 mm

16-159 - 168
JACKSON
German Silver

Tound-and Tracheal Hooks and Dilators



16-169
BOSE
165 mm

16-170
BOSE
165 mm

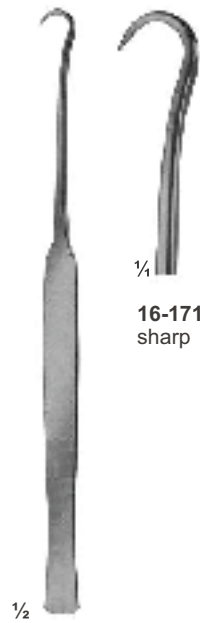

16-171 - 173
180 mm



16-172
blunt

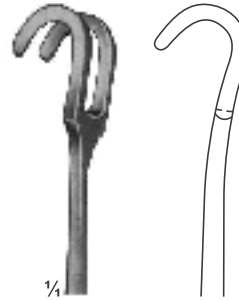

16-173
stumpf/blunt



16-174
FINSEN
50 mm



16-175
FINSEN
70 mm



16-176
TROUSSEAU
120 mm



16-177
LABORDE
125 mm



16-178
LABORDE
strong pattern
135 mm



16-179
Cleaning Brush
for tracheal tubes
285 mm

Irrigating Cannulae, Embolus Grasping Forceps, Dilators

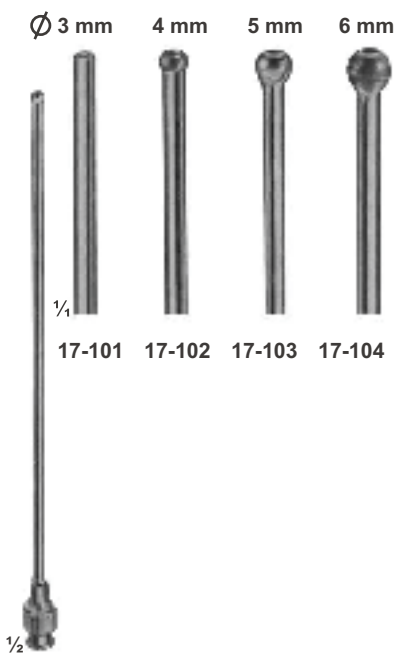

17-101 - 104
SCHMID
Vessel irrigating cannulae,
malleable, silver plated
150 mm

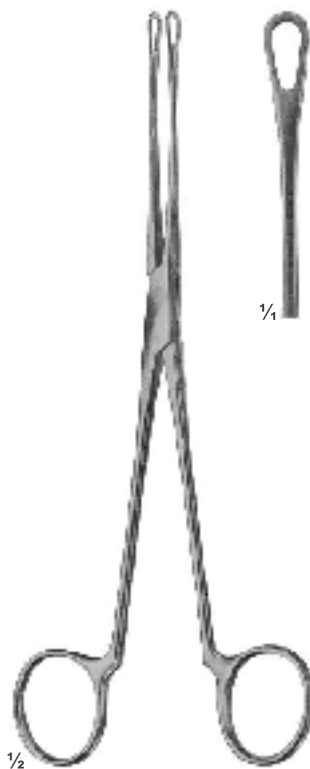

17-105
BLAKE
Embolus grasping
forceps
205 mm

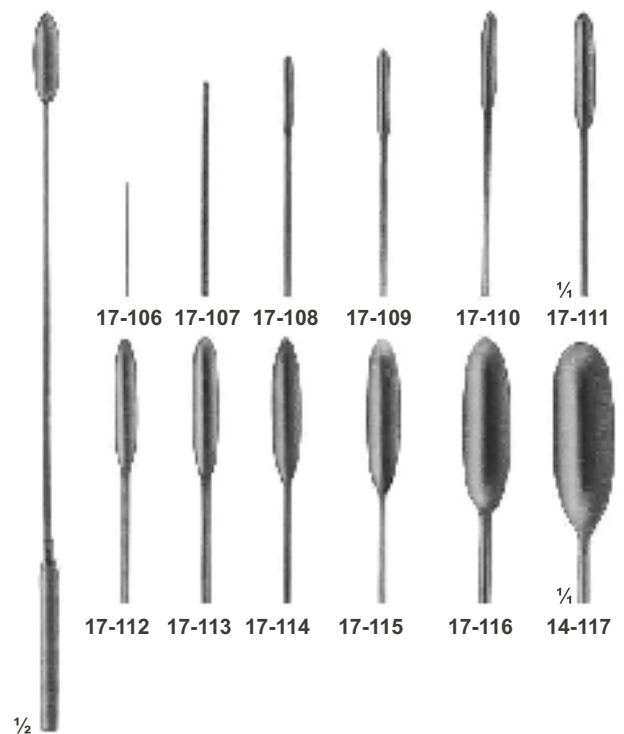

17-106 - 117
DE BAKEY
Vascular dilators,
malleable
190 mm

| | |
|------------------------|------------------------|
| 17-106 0,5 mm Ø | 17-112 3,5 mm Ø |
| 17-107 1,0 mm Ø | 17-113 4,0 mm Ø |
| 17-108 1,5 mm Ø | 17-114 4,5 mm Ø |
| 17-109 2,0 mm Ø | 17-115 5,0 mm Ø |
| 17-110 2,5 mm Ø | 17-116 7,0 mm Ø |
| 17-111 3,0 mm Ø | 17-117 9,0 mm Ø |

Irrigating Cannulae, Embolus Grasping Forceps, Dilators

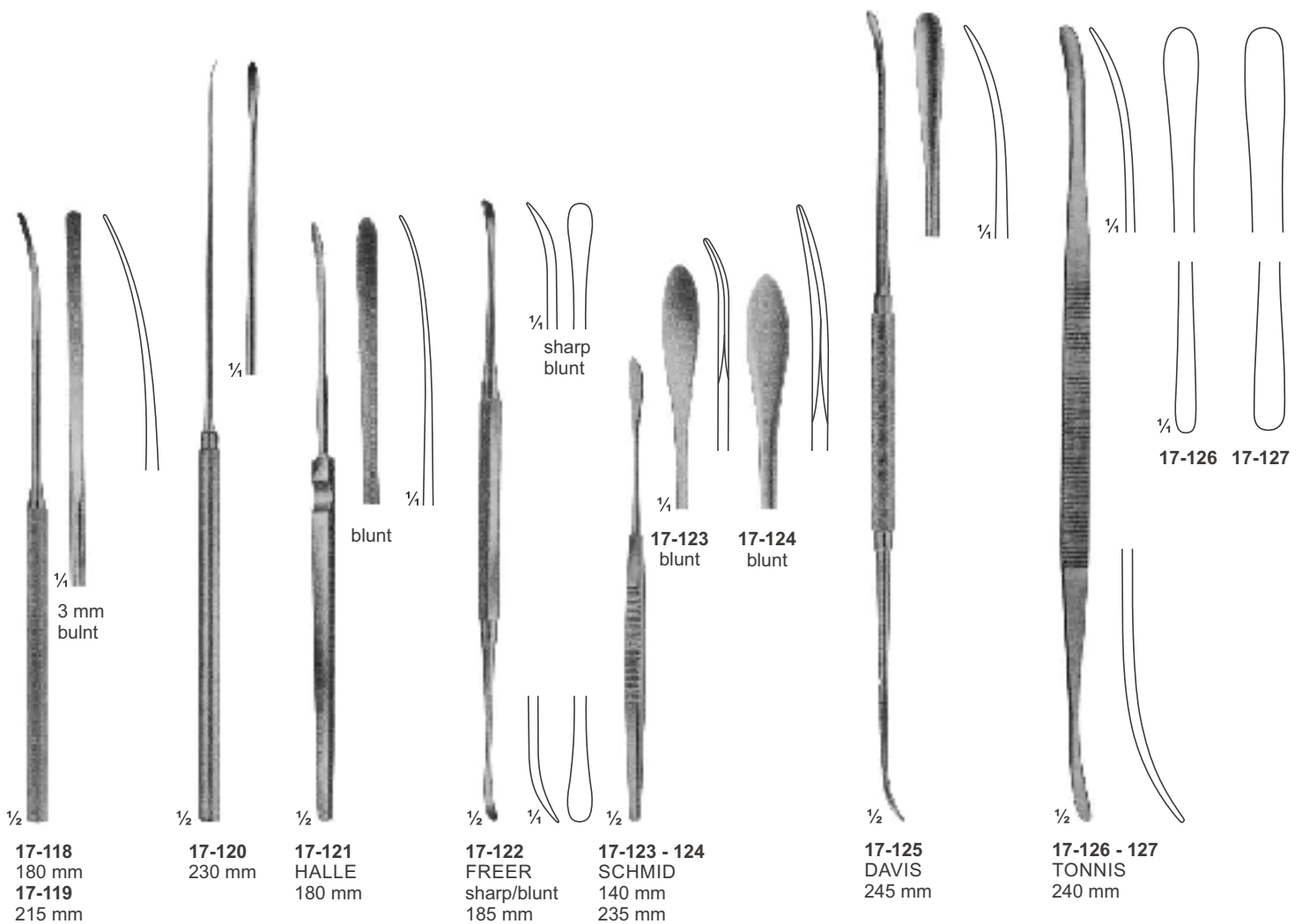

Irrigating Cannulae, Embolus Grasping Forceps, Dilators

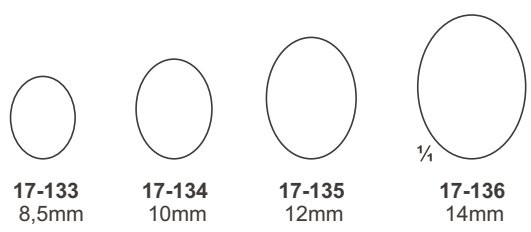
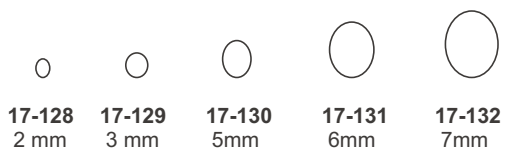

17-128 - 136
Endarterectomy strippers
550 mm



17-137
Handle for
110 mm

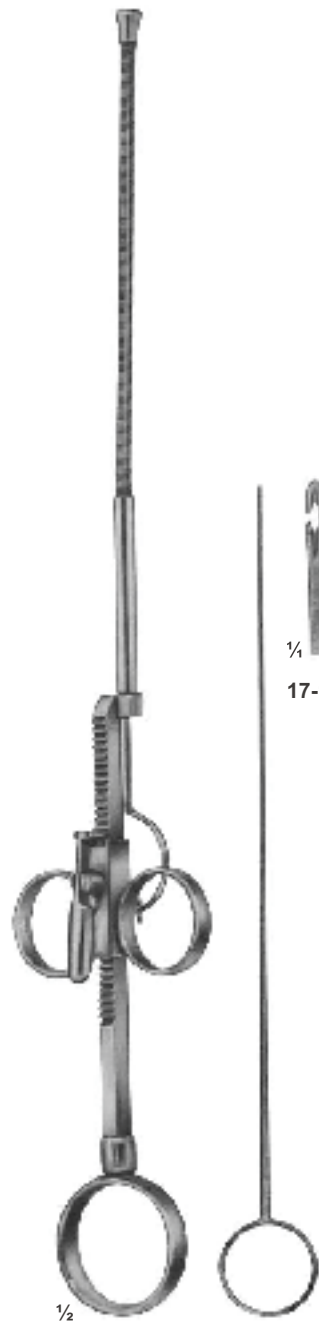

17-138 - 139
RUMEL-BELBONT
325 mm
17-138 - 4,0 mm Ø
17-139 - 6,4 mm Ø

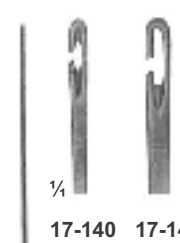

17-140 17-141



17-140 - 141
Guide only

Biopotome and Aortic Dilators

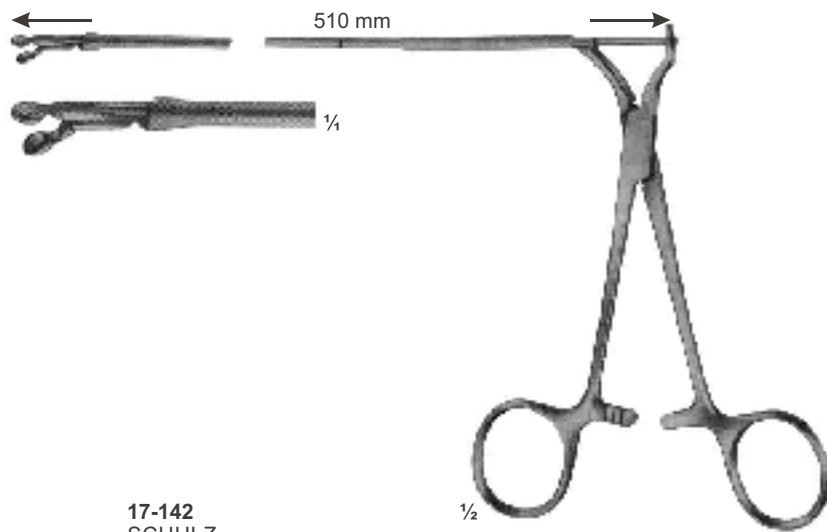

**17-142
SCHULZ**

Biopotome, mit flexiblem Schaft, 510 mm lang,
with round jaws 3 mm diam.

Biopsy forceps, for biopsy from the right atrium
through cava juglaris, prior to heart implantations.

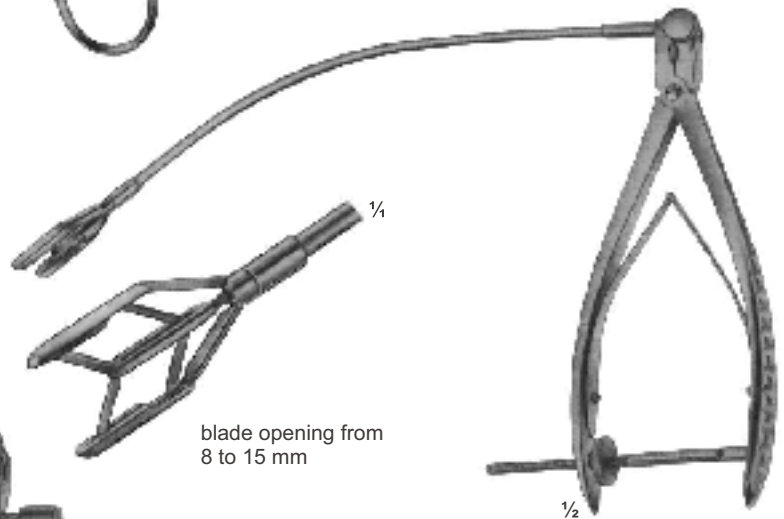

**17-144
COOLEY**
Dilator for
mitral valve
for children

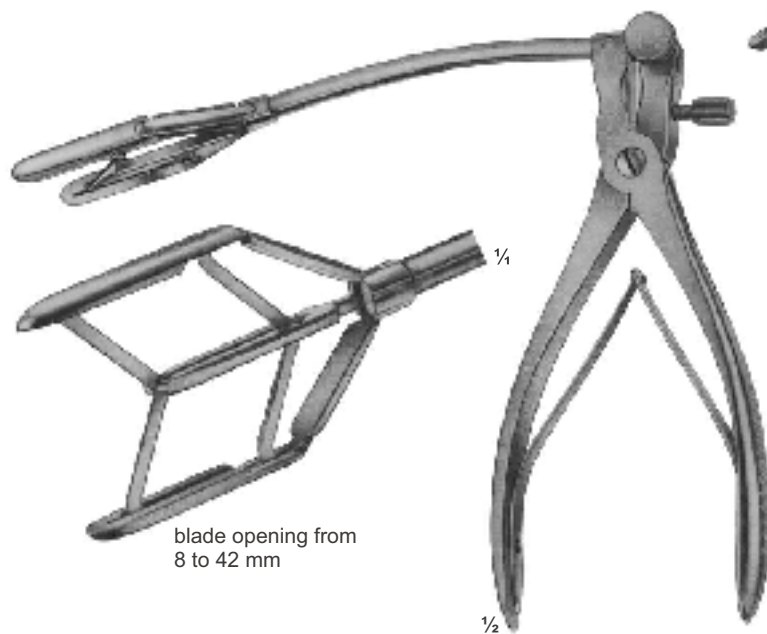

**17-143
TUBBS**
Dilator for
mitral valve

Biopotome and Aortic Dilators

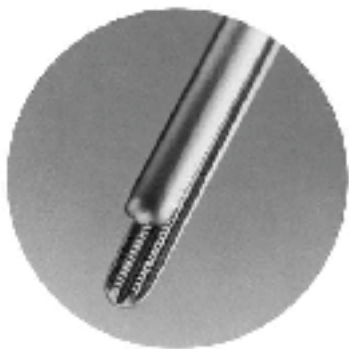
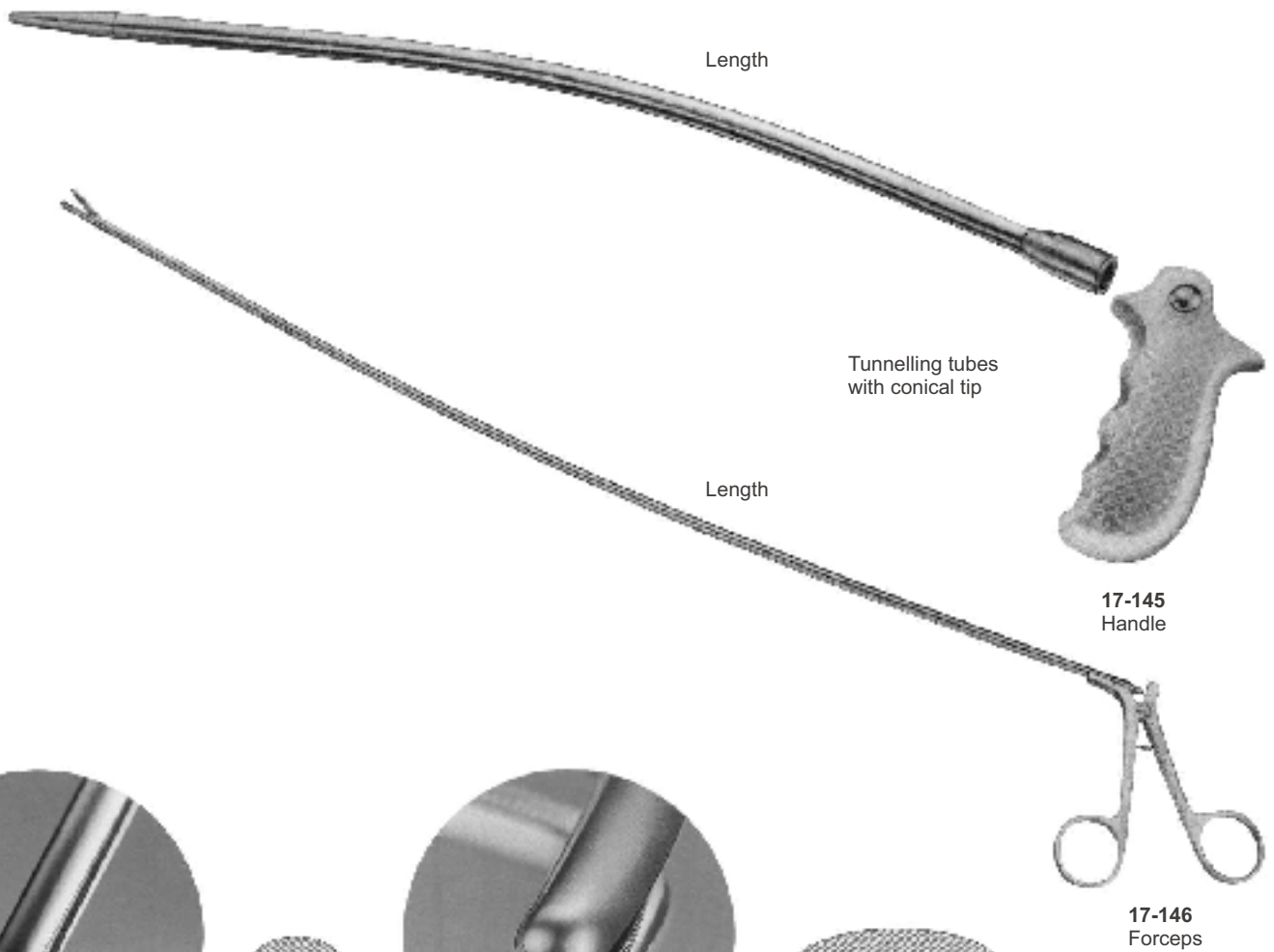

DE BAKEY

17-147
1 : 2 rows of teeth



DE BAKEY

17-148
2 : 3 rows of teeth

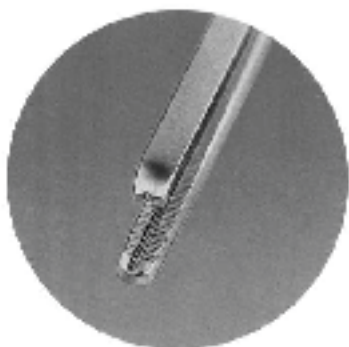

COOLEY

17-149
2 : 2 rows of teeth

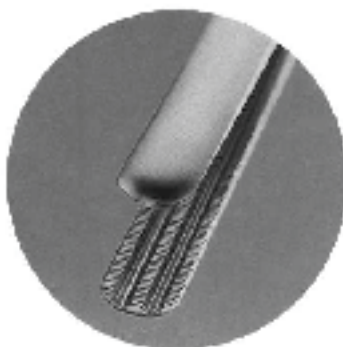

DARDIK

17-150
2 : 3 rows of teeth

Ultra-Light-Forceps

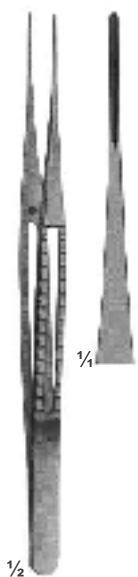

17-151
Width of jaws
1,5 mm
Length
150mm

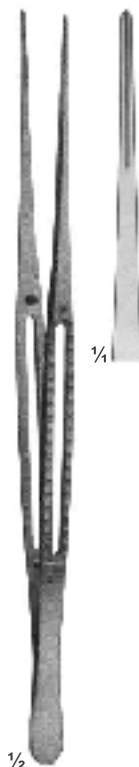

17-152
1,5 mm
200 mm



17-153
1,5 mm
240 mm



17-154
1,5 mm
300 mm

Ultra-Light-Forceps

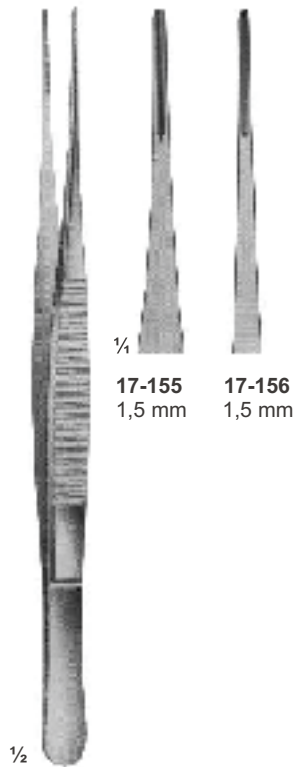

1/4
17-155
1,5 mm
17-156
1,5 mm

1/2
17-155 - 156
DE BAKEY
150 mm
300 mm

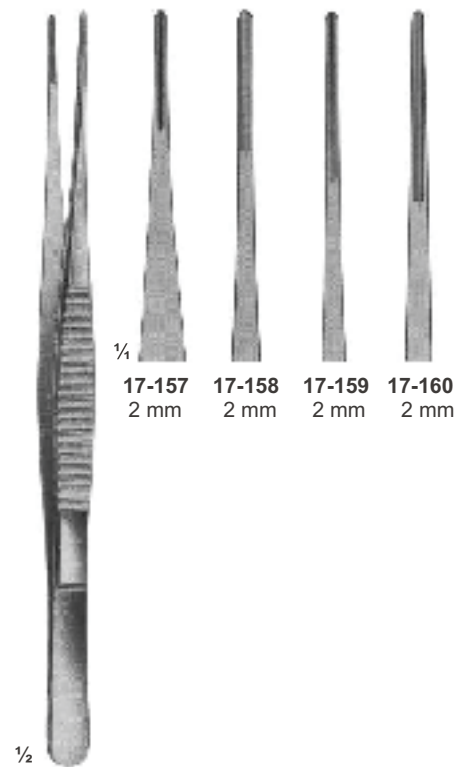

1/4
17-157
2 mm
17-158
2 mm
17-159
2 mm
17-160
2 mm

1/2
17-157 - 160
DE BAKEY
150 mm 200 mm
300 mm 240 mm

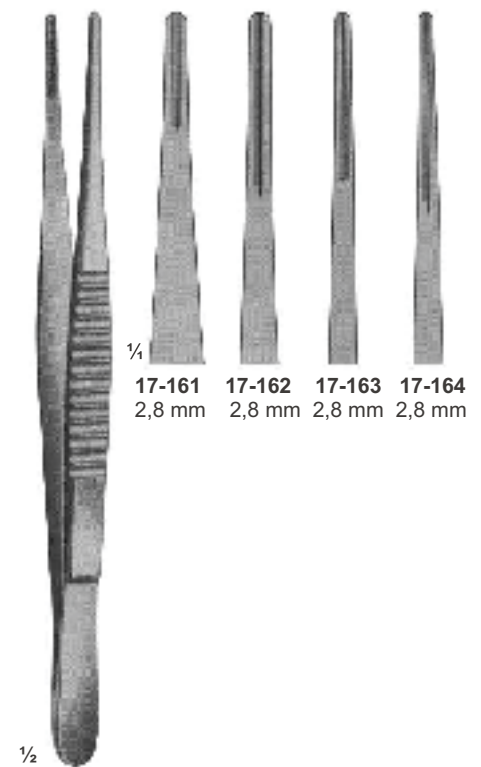

1/4
17-161
2,8 mm
17-162
2,8 mm
17-163
2,8 mm
17-164
2,8 mm

1/2
17-161 - 164
DE BAKEY
150 mm 200 mm
300 mm 240 mm

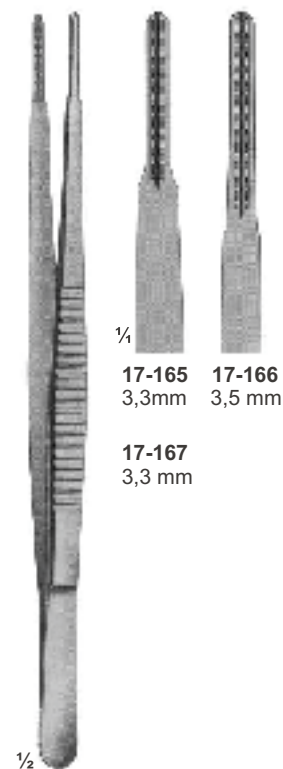

1/4
17-165
3,3mm
17-166
3,5 mm

17-167
3,3 mm

1/2
17-165 - 167
DE BAKEY
200 mm
300 mm 240 mm

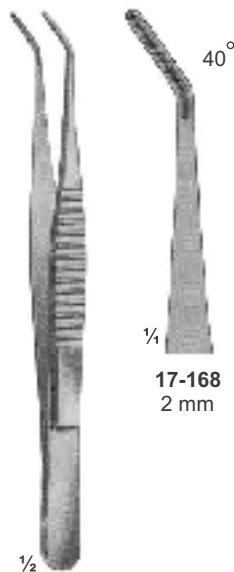

1/4
17-168
2 mm

1/2
17-168
DE BAKEY
150 mm

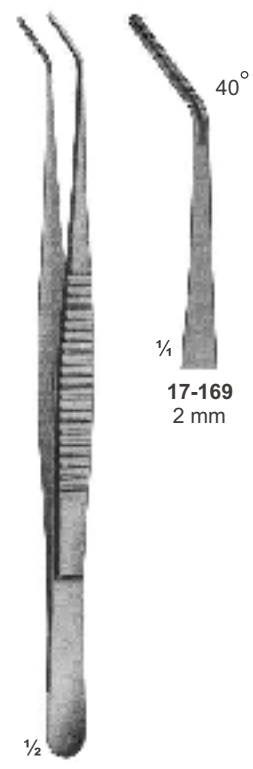

1/4
17-169
2 mm

1/2
17-169
DE BAKEY
200 mm

Ring Handle Bulldog Clamps

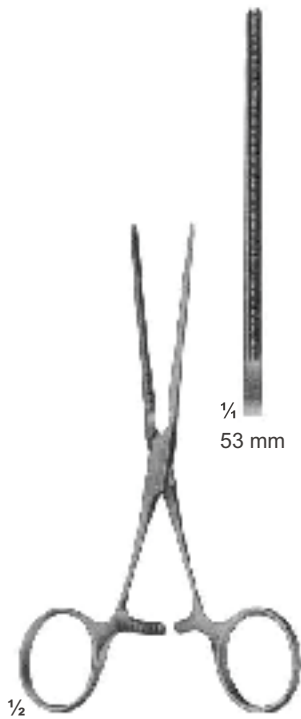

17-170
DE-BAKEY
gerade straight
130 mm

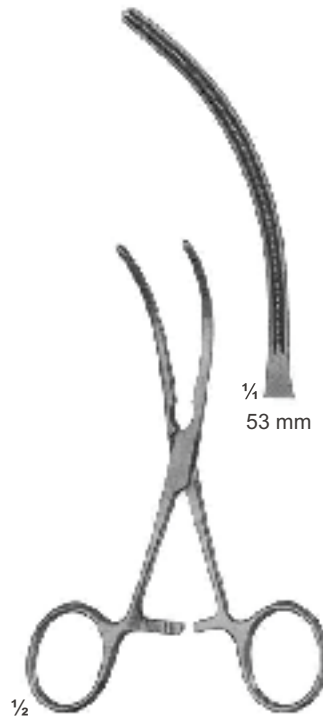

17-171
DE-BAKEY
Maul gebogen
curved jaws
125 mm

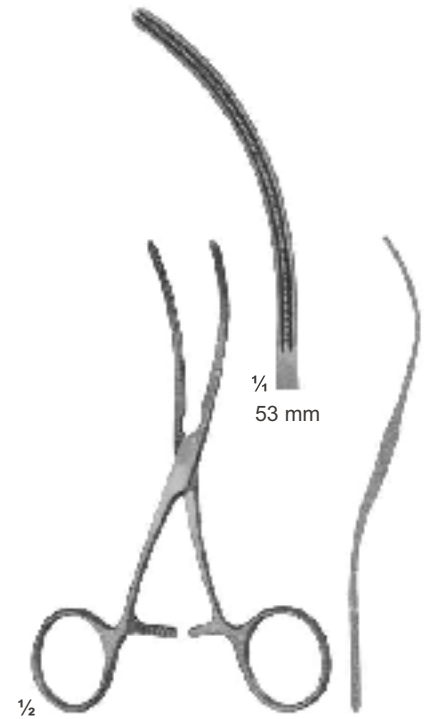

17-172
DE-BAKEY
S-shaped curved
125 mm

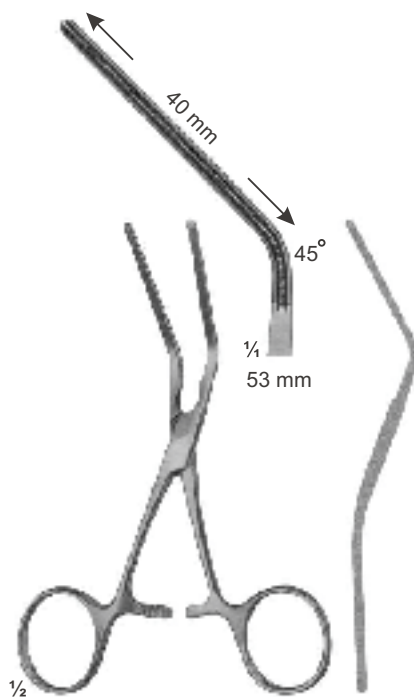

17-173
DE-BAKEY
45° winklig gebogen
angled 45°
125 mm

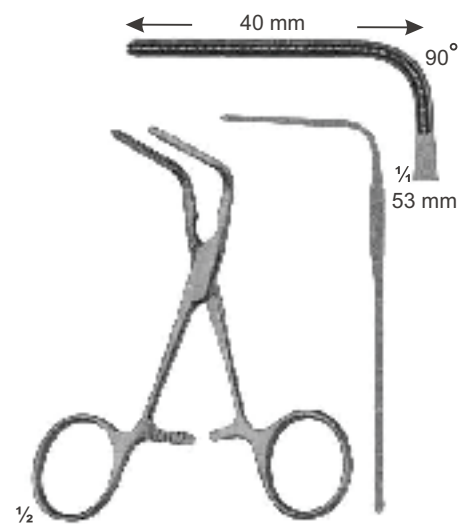

17-174
DE-BAKEY
90° winklig gebogen
angled 90°
105 mm

Anastomosis-and Multi-Purpose-Clamps for Neonatales

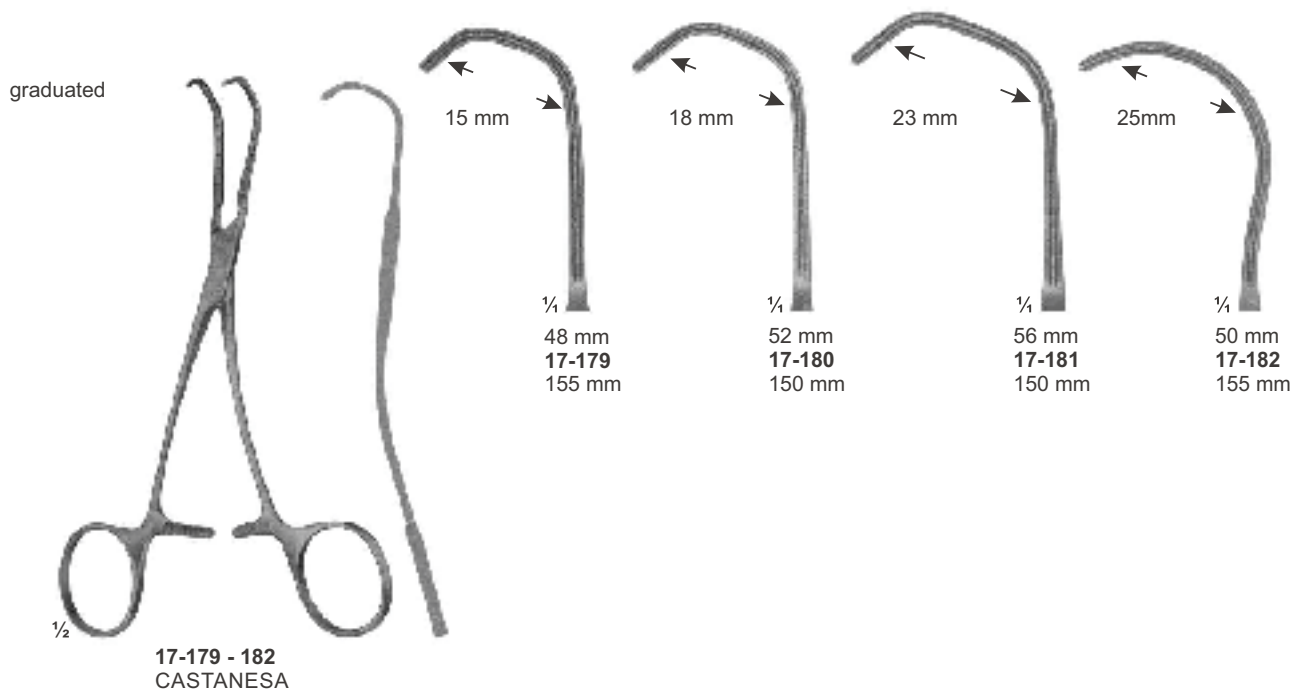
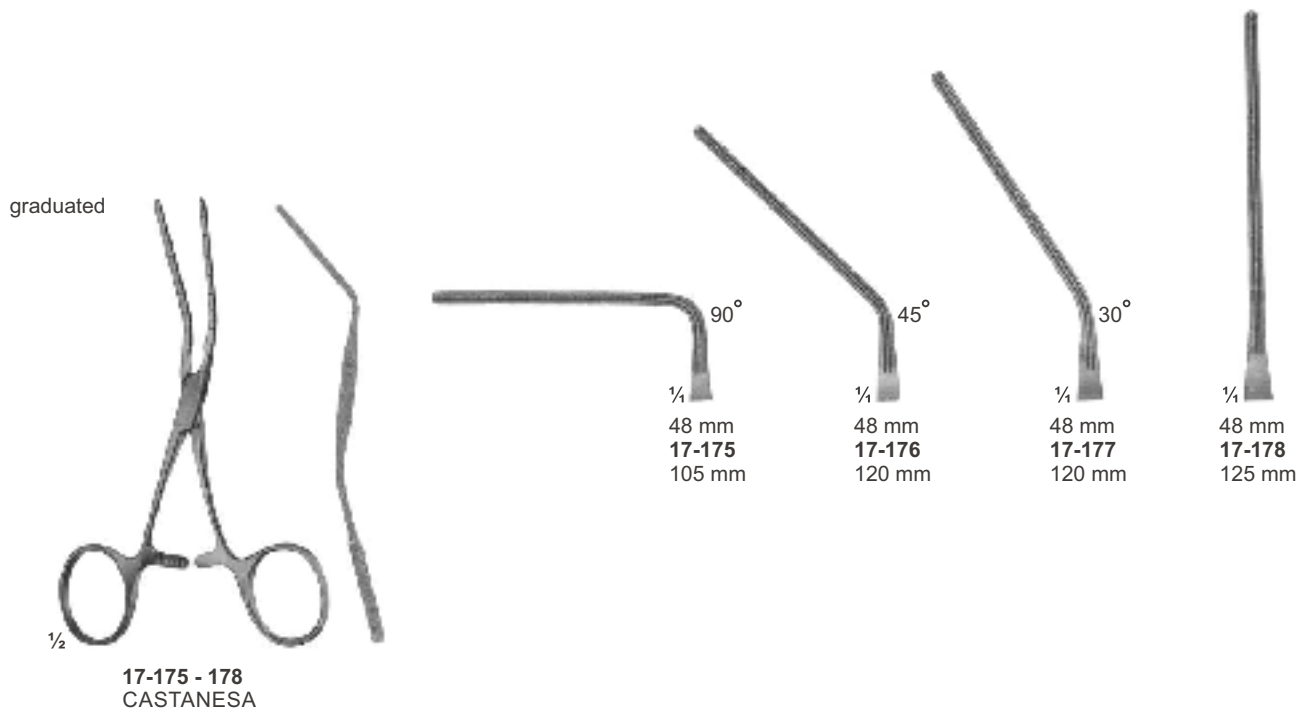

Anastomosis-and Multi-Purpose-Clamps-Pediatric types

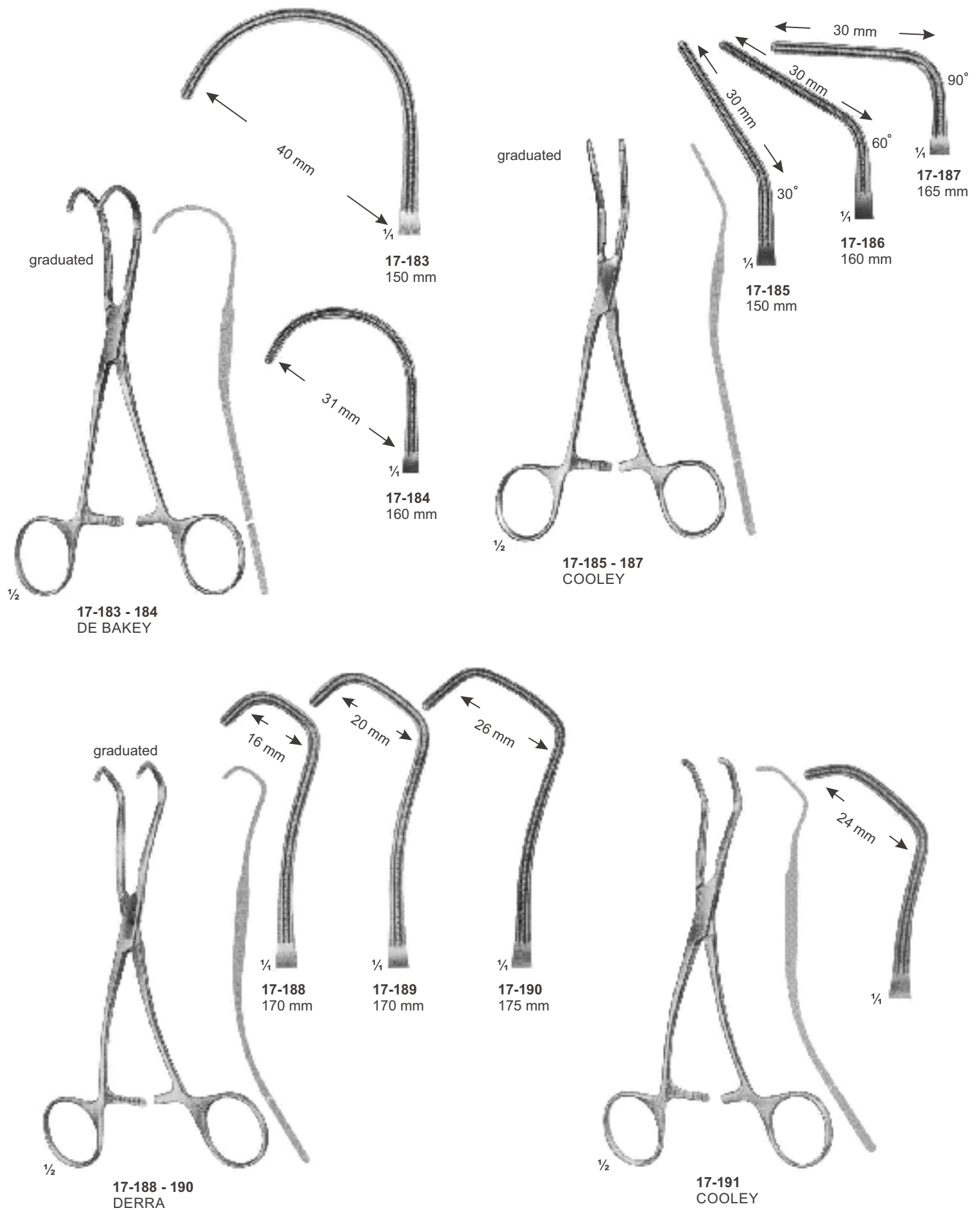

Non-traumatic Haemostatic Forceps

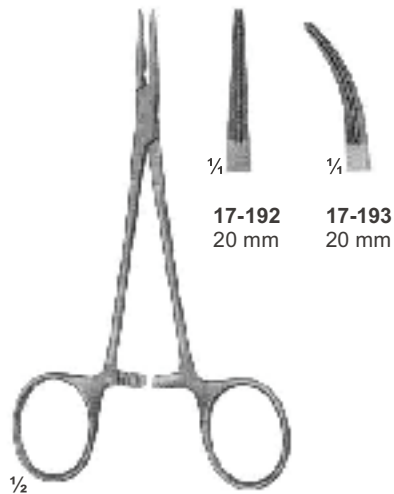

17-192
20 mm

17-193
20 mm

17-192 - 193
125 mm

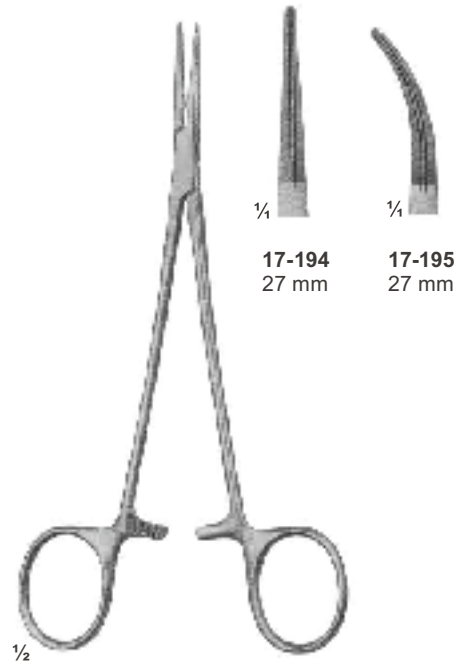

17-194
27 mm

17-195
27 mm

17-194 - 195
165 mm

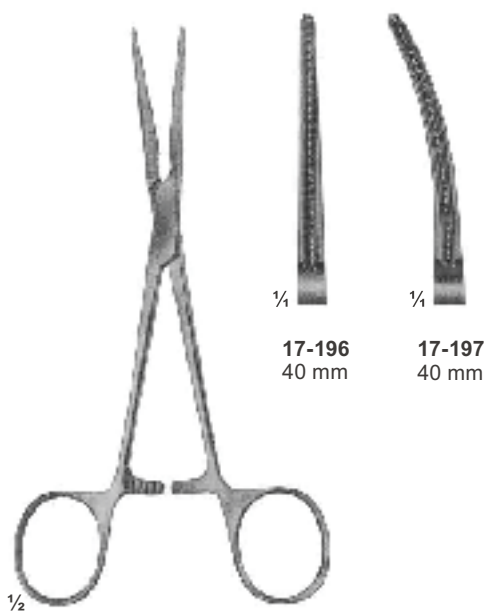

17-196
40 mm

17-197
40 mm

17-196 - 197
DE BAKEY-BAINRIDGE
155 mm

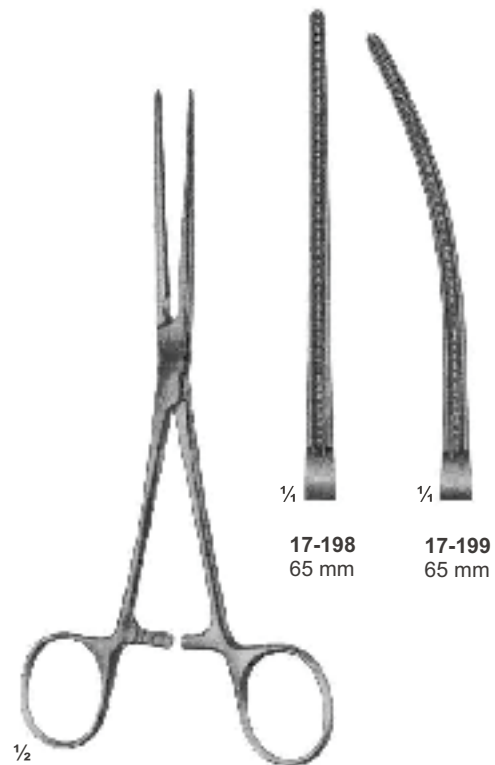

17-198
65 mm

17-199
65 mm

17-198 - 199
DE BAKEY-BAINRIDGE
180 mm

Non-traumatic Haemostatic Forceps

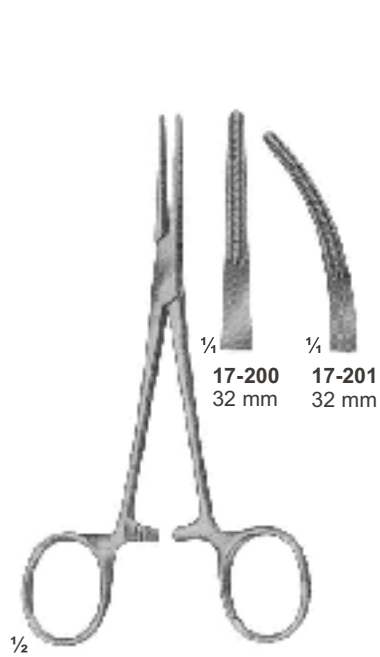

17-200 - 201
DE-BAKEY-KELLY
140 mm

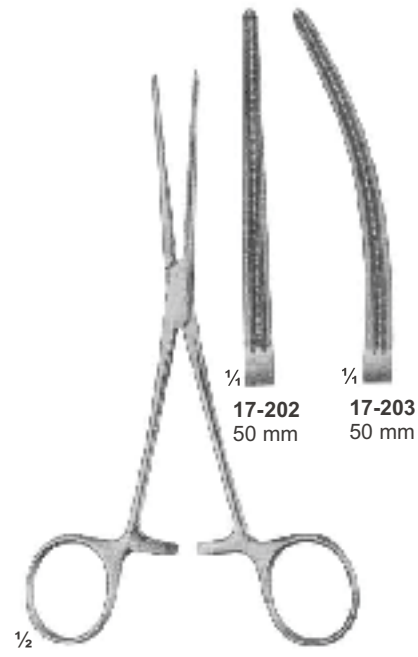

17-202 - 203
PEAN
155 mm

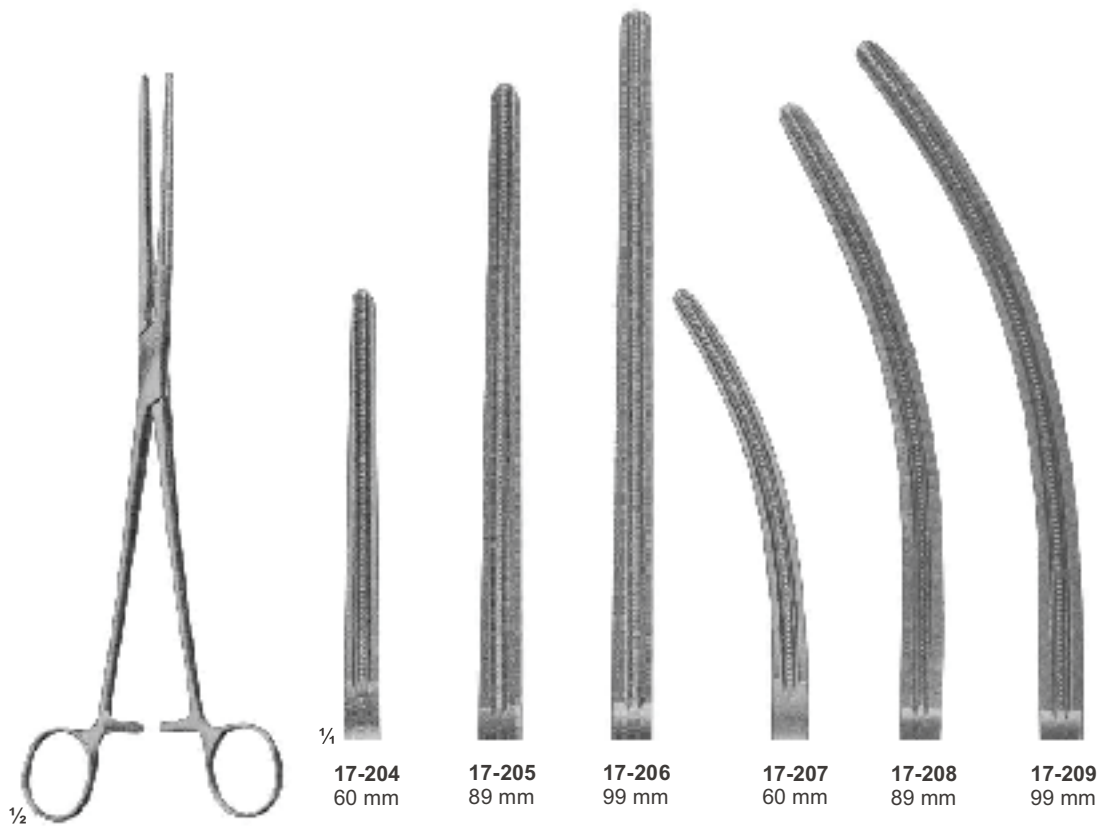

17-204 - 209
DE-BAKEY-PEAN DE-BAKEY-PEAN
17-204 200 mm 17-207 200 mm
17-205 265 mm 17-208 260 mm
17-206 280 mm 17-209 275 mm

Anastomosis Clamps

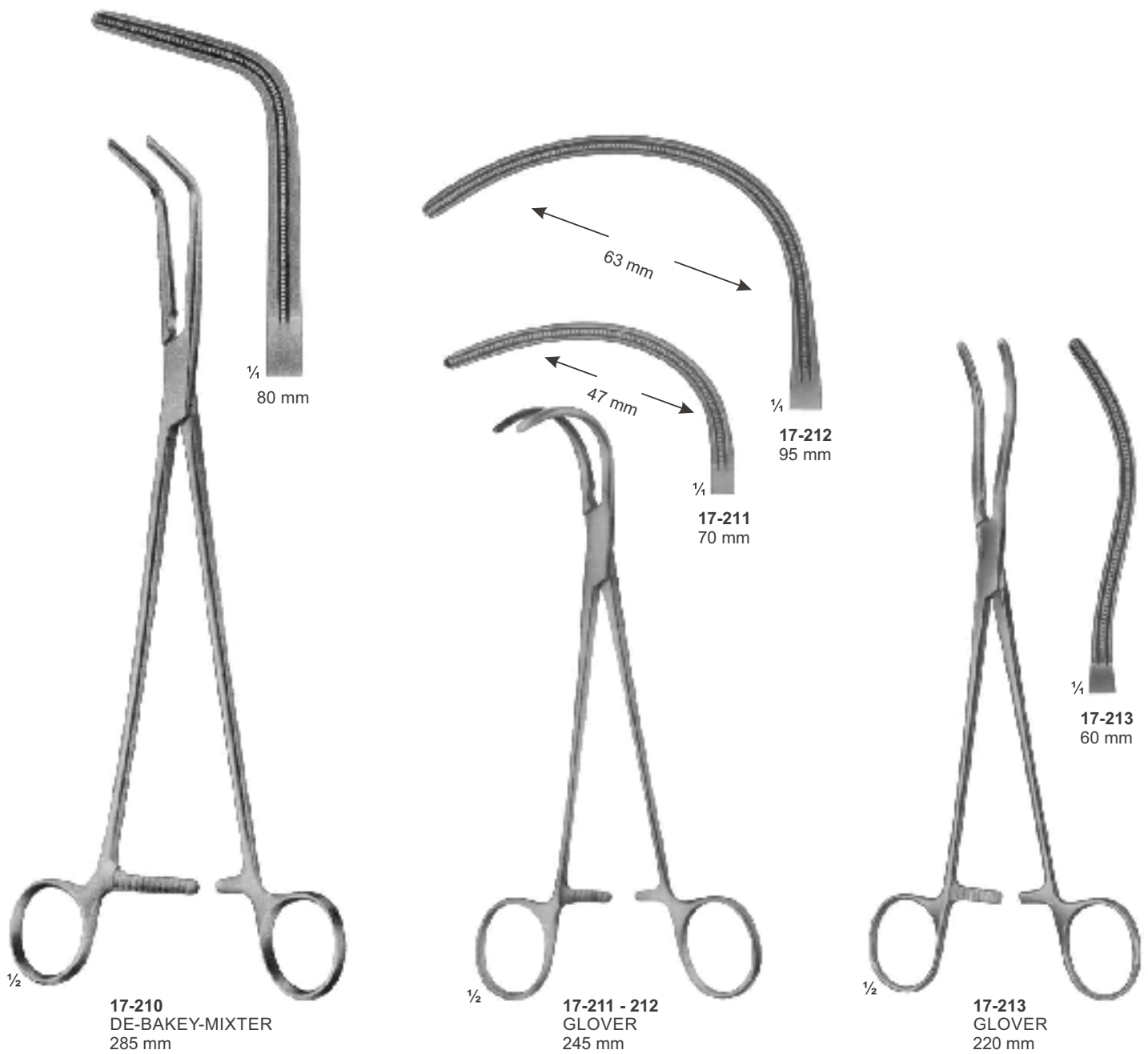

Vena-Cava Clamps

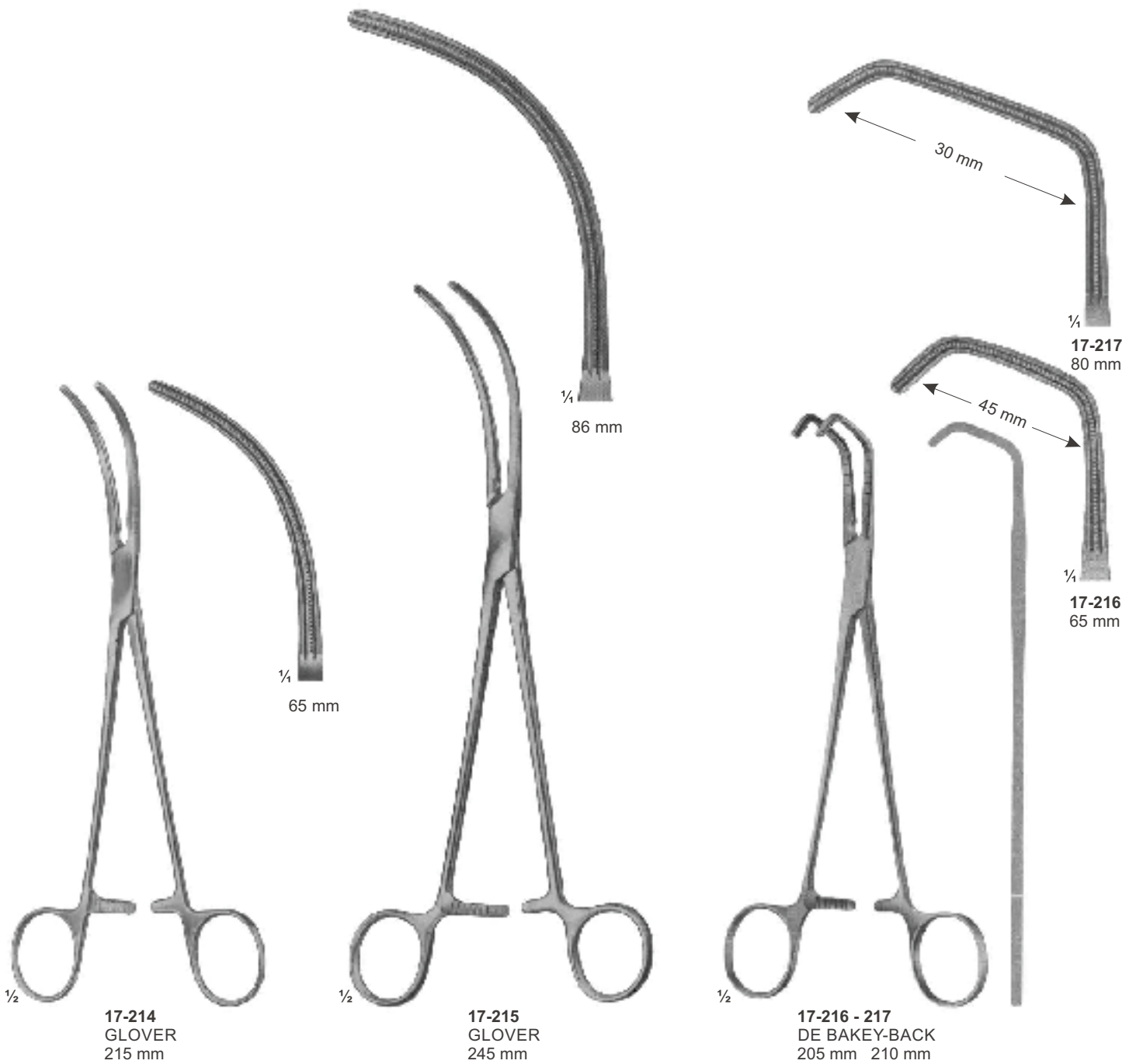

Vena-Cava Clamps

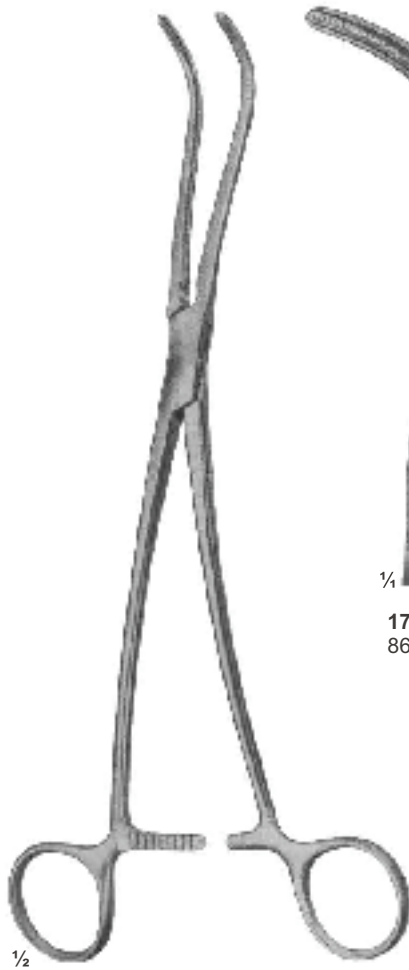

1/2

1/4

17-218
86 mm

1/4

17-219
86 mm

1/4

17-220
86 mm

1/4

17-221
86 mm

17-218 - 221
DE BAKEY-HARKEN
17-218 - 255 mm
17-219 - 245 mm
17-220 - 245 mm
17-221 - 245 mm



1/2

17-222 - 226
DE BAKEY

Total Length: 220 mm

Length of jaws: 85 mm

1/4

17-222

36 mm

1/4

17-223

48 mm

1/4

17-224

54 mm

1/4

17-225

58 mm

58 mm

1/4

17-226

75 mm

75 mm

220 mm 256 mm 270 mm 270 mm 280 mm
85 mm 95 mm 99 mm 103 mm 119 mm

Vena-Cava Clamps

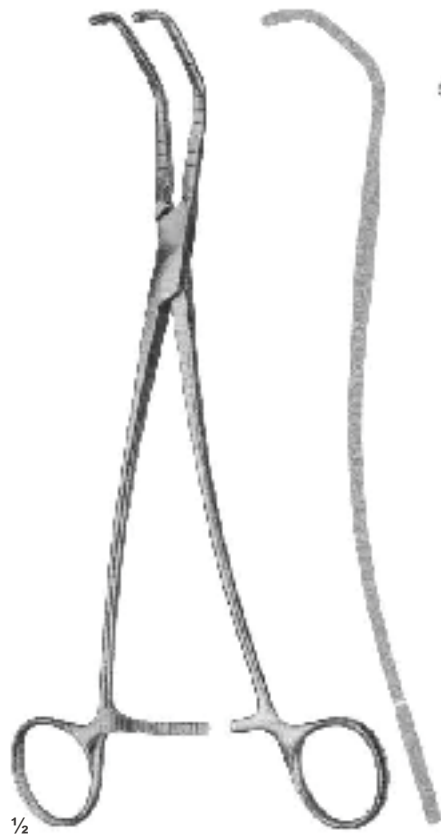

1/2

17-227 - 229
DE BAKEY-SATINSKY
235 mm, 240 mm, 245 mm

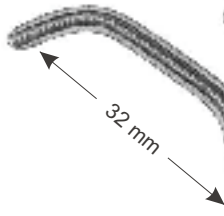

32 mm

1/4

17-227
68 mm

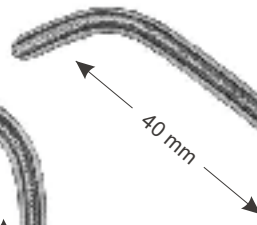

40 mm

1/4

17-228
76 mm

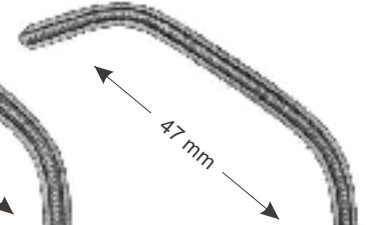

47 mm

1/4

17-229
84 mm

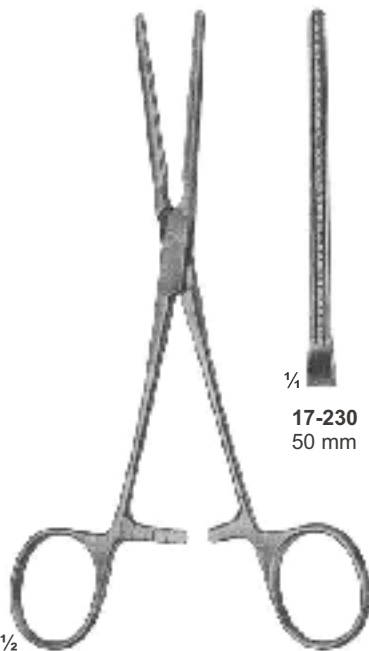

1/2

17-230 - 231
DE BAKEY
170 mm, 165 mm

1/4

17-230
50 mm

1/4

17-231
50 mm



1/2

17-232
DE BAKEY
165 mm

1/4

50 mm

Vena-Cava Clamps



17-233 - 235
DE BAKY
205 mm, 225 mm, 240 mm



17-233
41 mm



17-234
65 mm



17-235
80 mm



17-236 - 238
DE BAKY
200 mm, 225 mm, 240 mm



17-236
41 mm



17-237
65 mm



17-238
80 mm

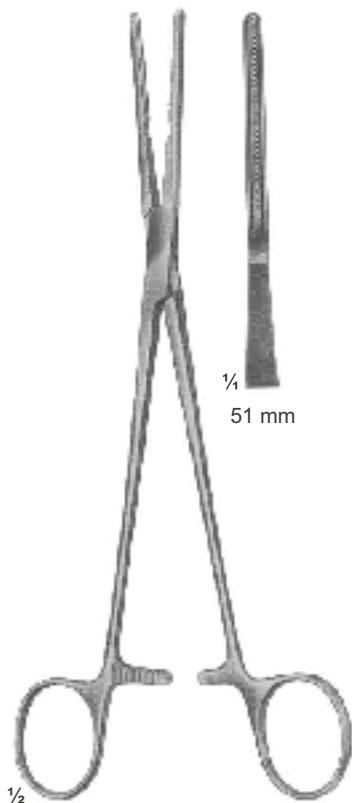

17-239
DE BAKY
210 mm



17-239
51 mm



17-240
DE BAKY
210 mm



17-240
15°
51 mm



17-241
DE BAKY
160 mm



17-241
56 mm

Vena-Cava Clamps

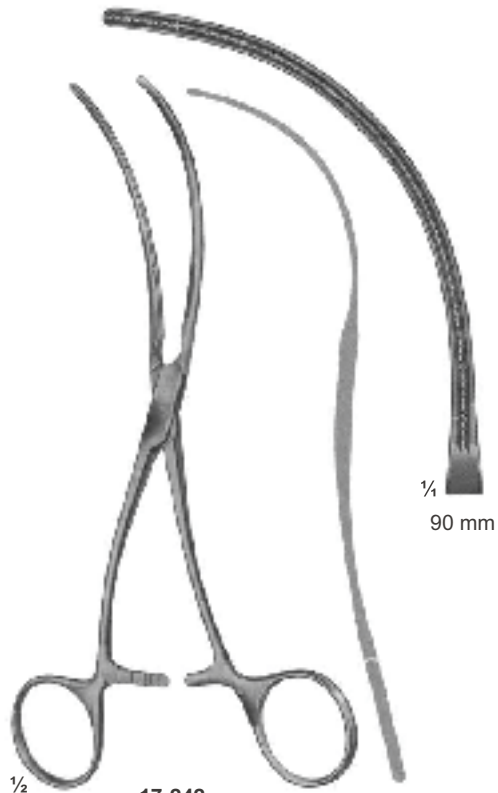

17-242
DE BAKEY
190 mm

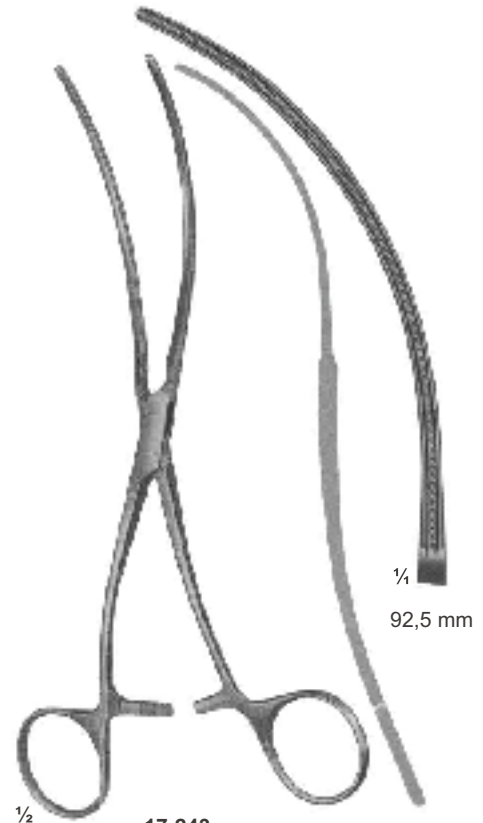

17-243
DE BAKEY
200 mm

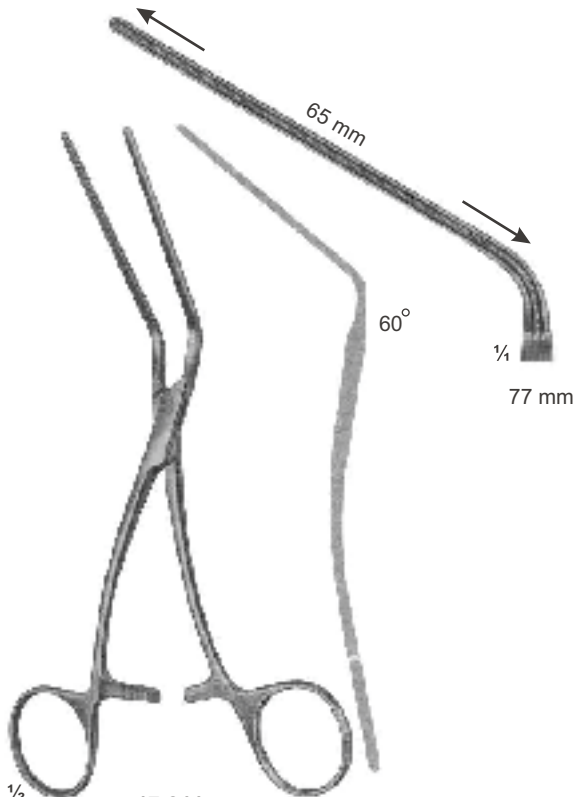

17-244
DE BAKEY
180 mm

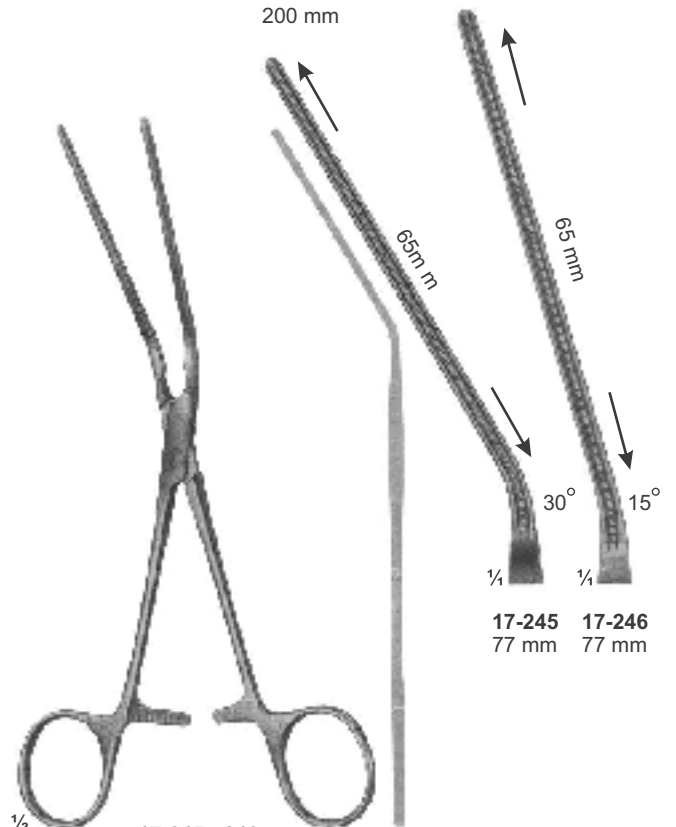

17-245 **17-246**
77 mm 77 mm

17-245 - 246
DE BAKEY
190 mm

Vena-Cava Clamps



17-247
LELAND-JONES
195 mm



17-248
DE BAKEY
200 mm

Iliac clamp

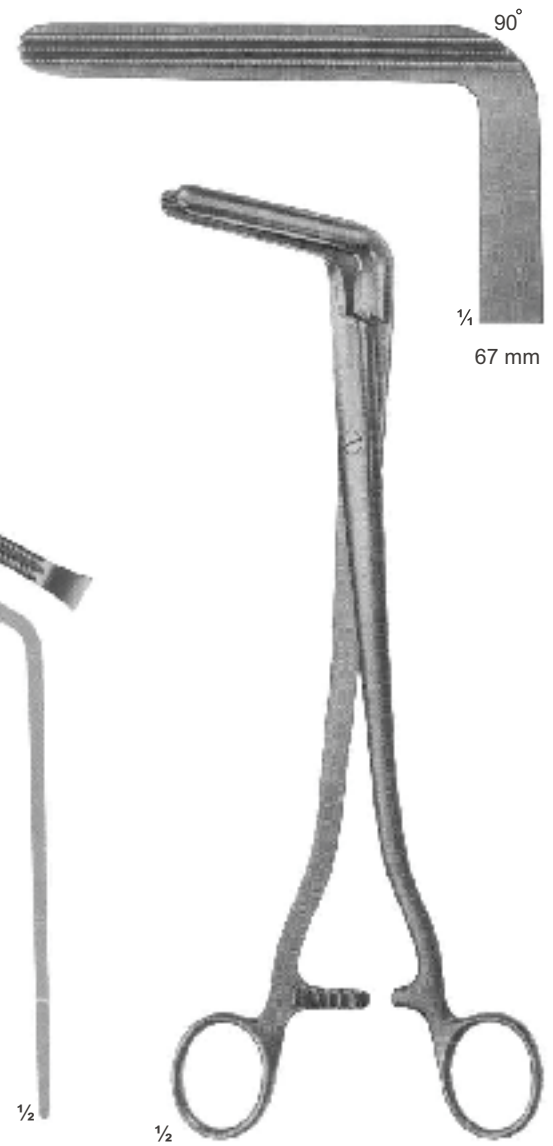

17-249
WERTHEIM
250 mm

Vena-Cava Clamps

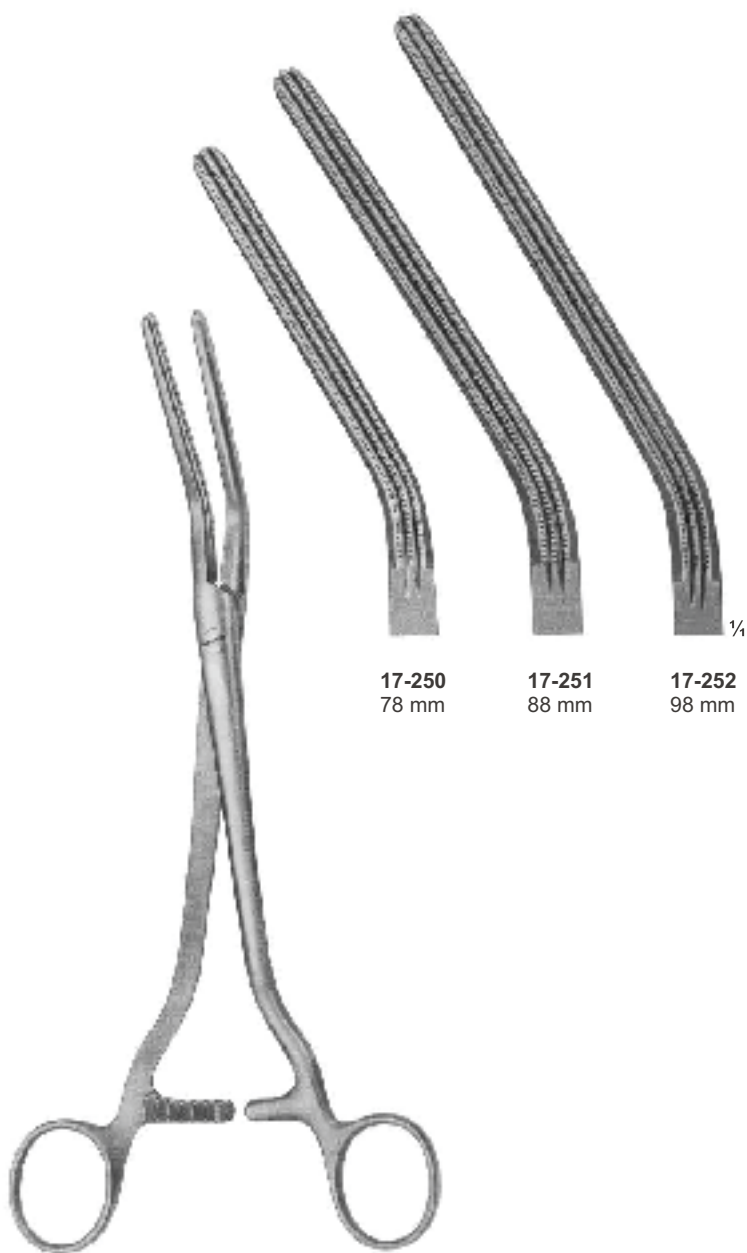

17-250
78 mm

17-251
88 mm

17-252
98 mm

17-250 - 252
DICK
255 mm, 265 mm, 275 mm

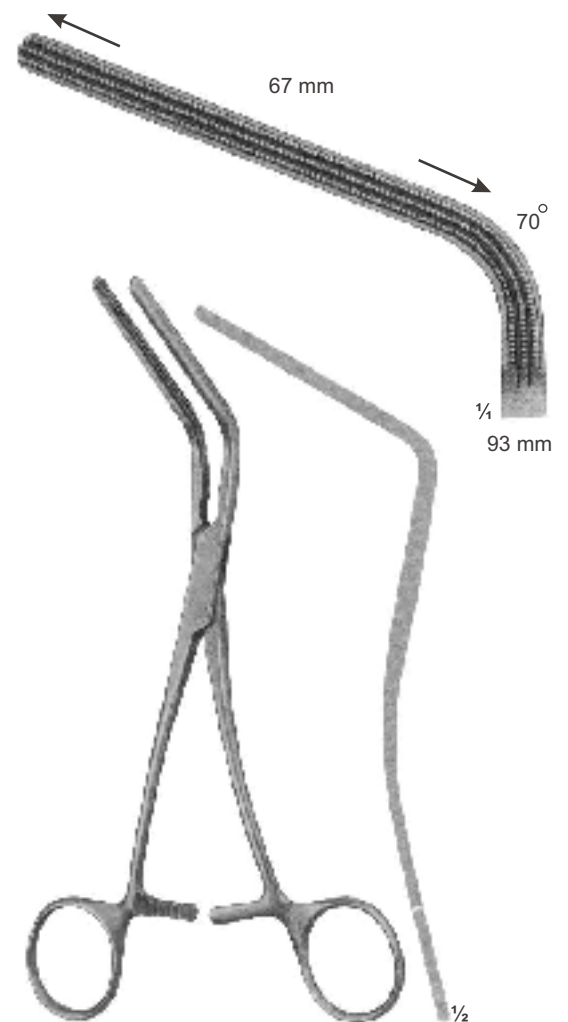

67 mm

70°

1/4
93 mm

17-253
MORRIS
175 mm

Vena-Cava Clamps

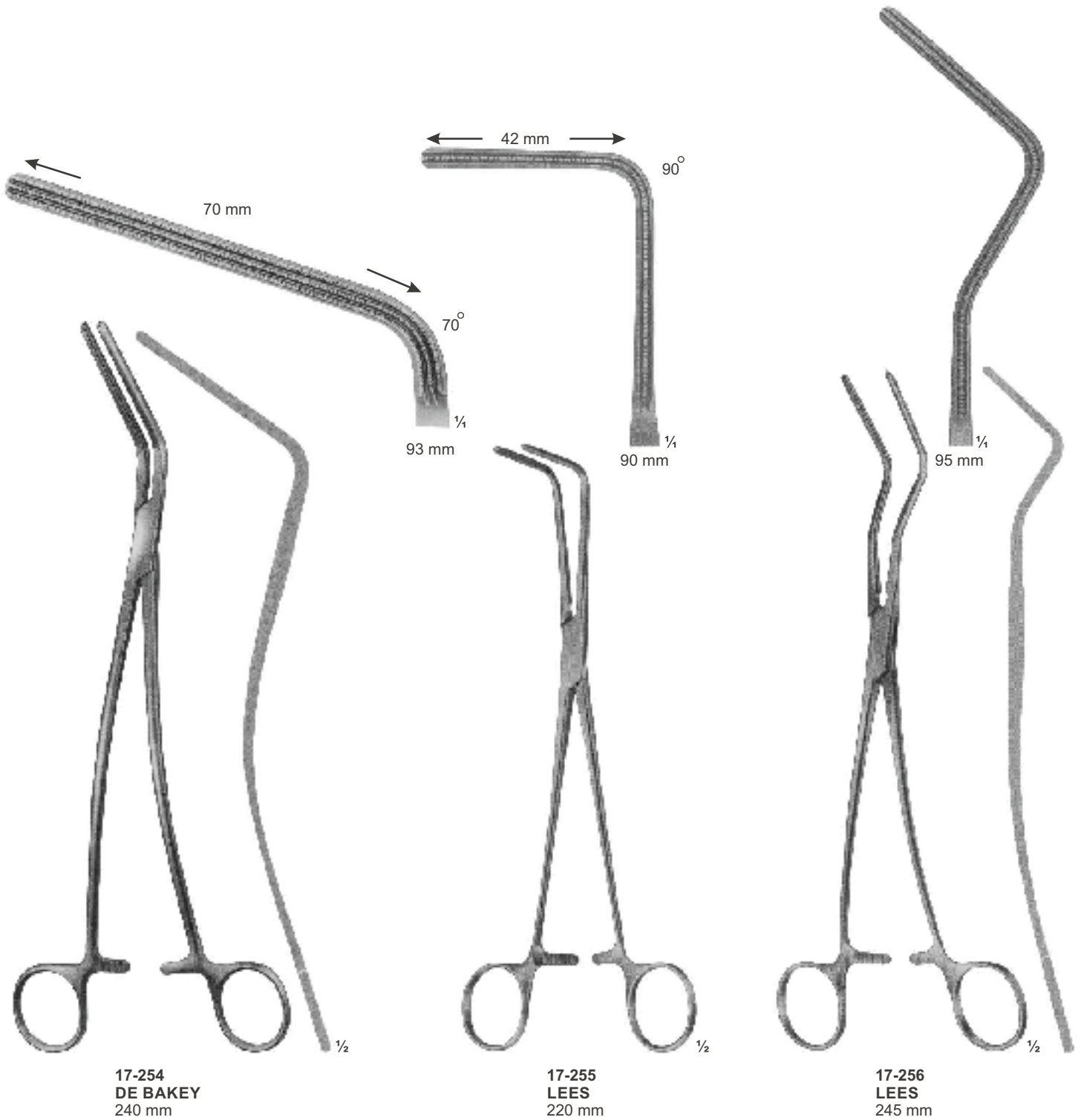

Vena-Cava Clamps

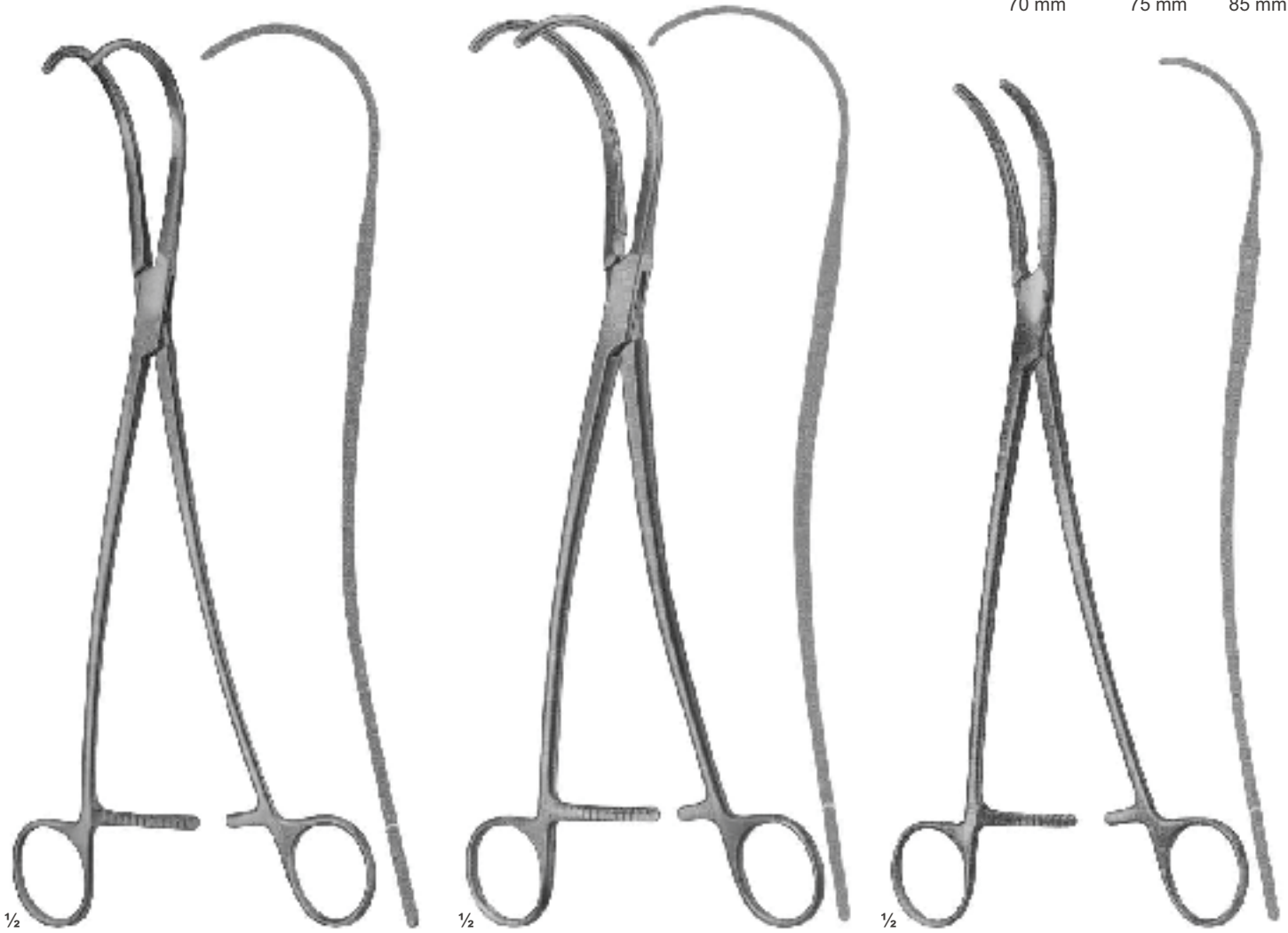
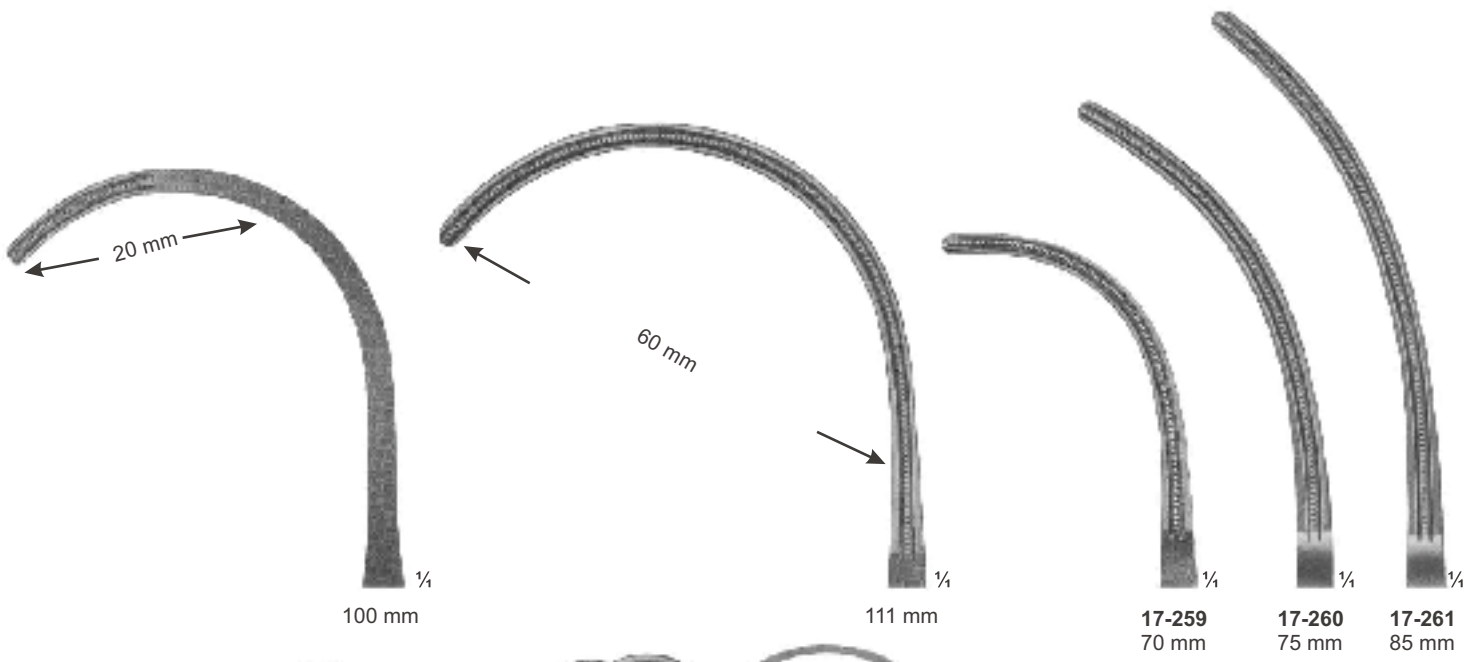

17-257
DE BAKEY
265 mm

17-258
DE BAKEY
270 mm

17-259 - 261
DE BAKEY
255 mm, 265 mm, 280 mm

Vena-Cava Clamps

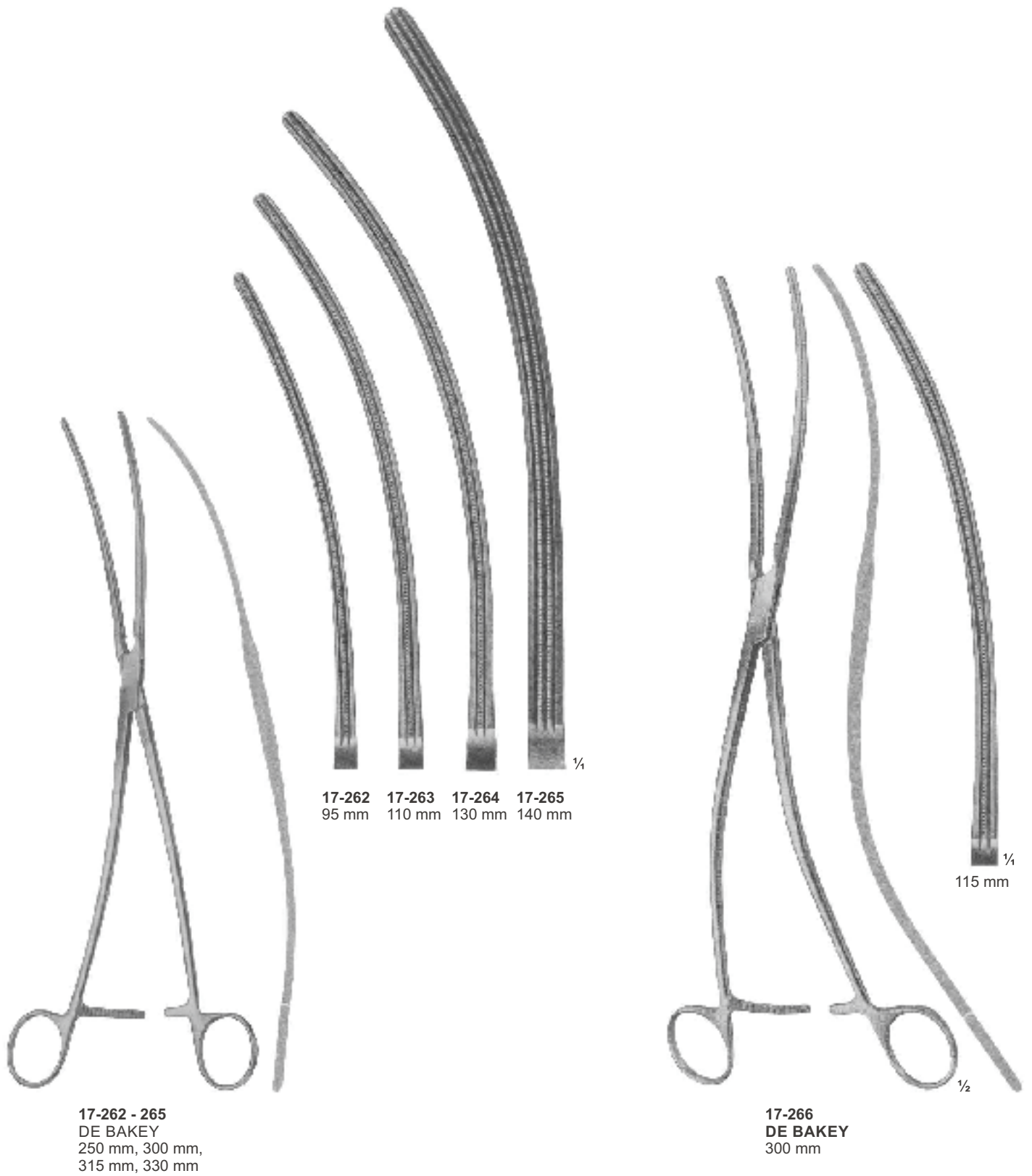

Vena-Cava Clamps

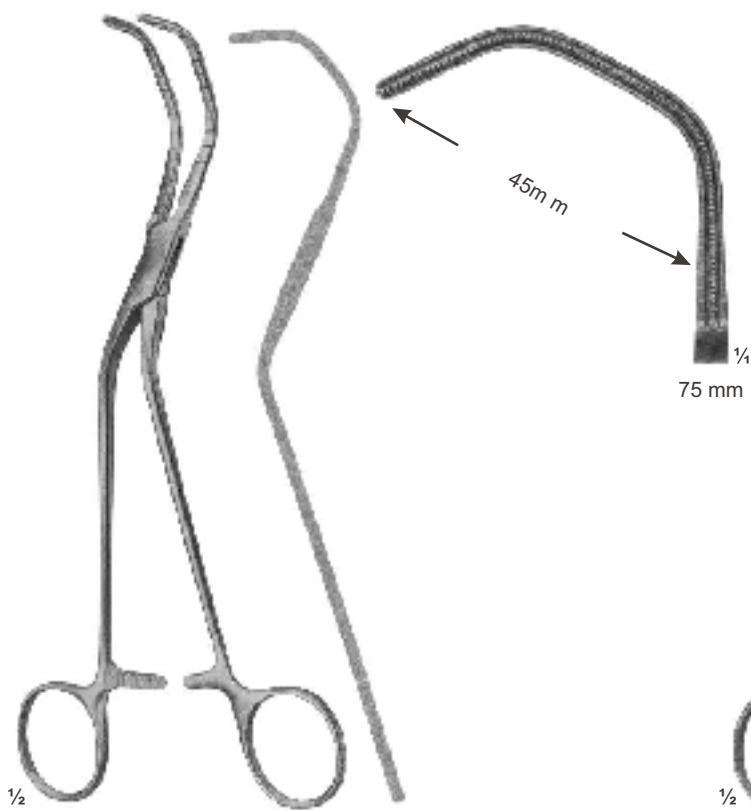

17-267
DIETRICH
210 mm

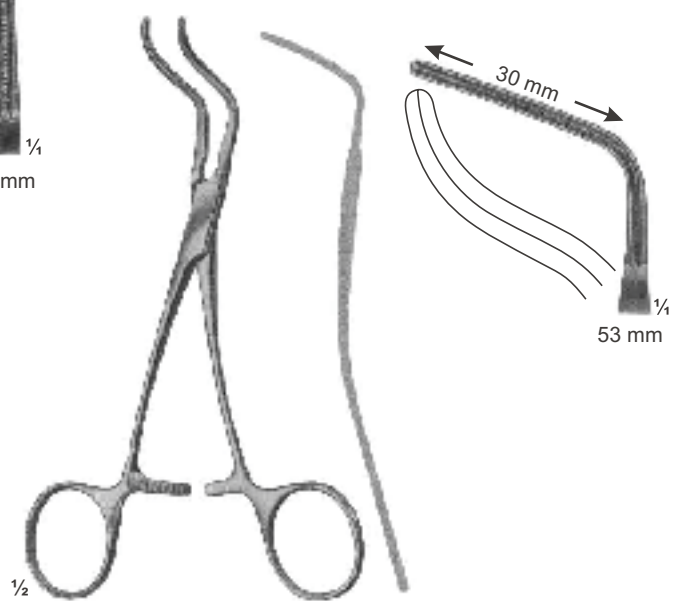

17-268
SUBRAMANIAN
155 mm

Vena-Cava Clamps

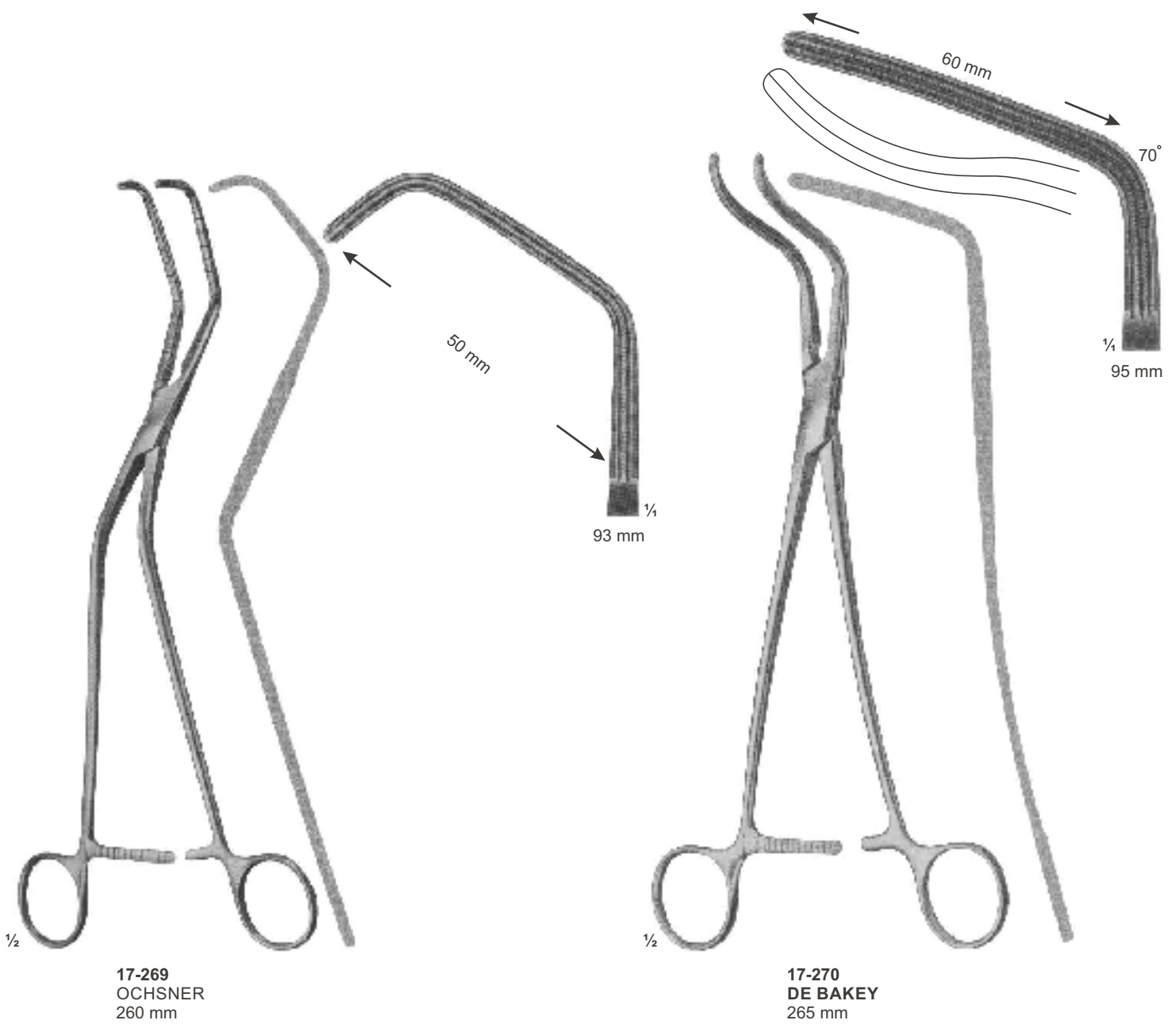

Aorta-Anastomosis Clamps

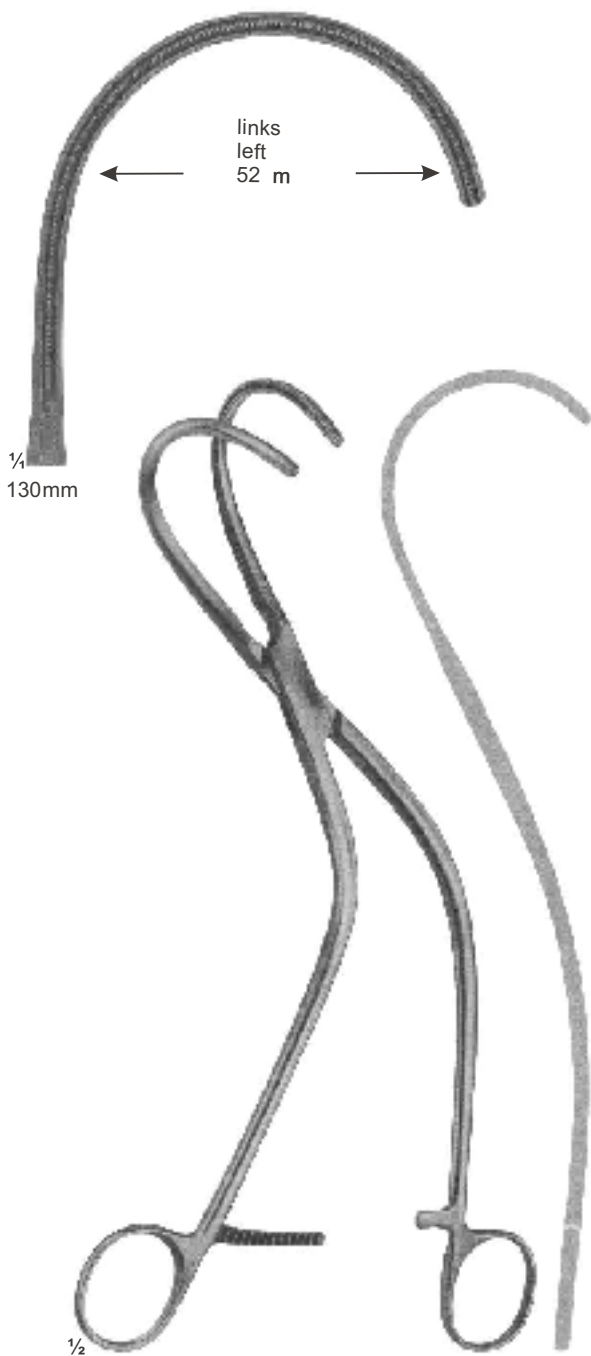

L
17-271
WEBER
265 mm

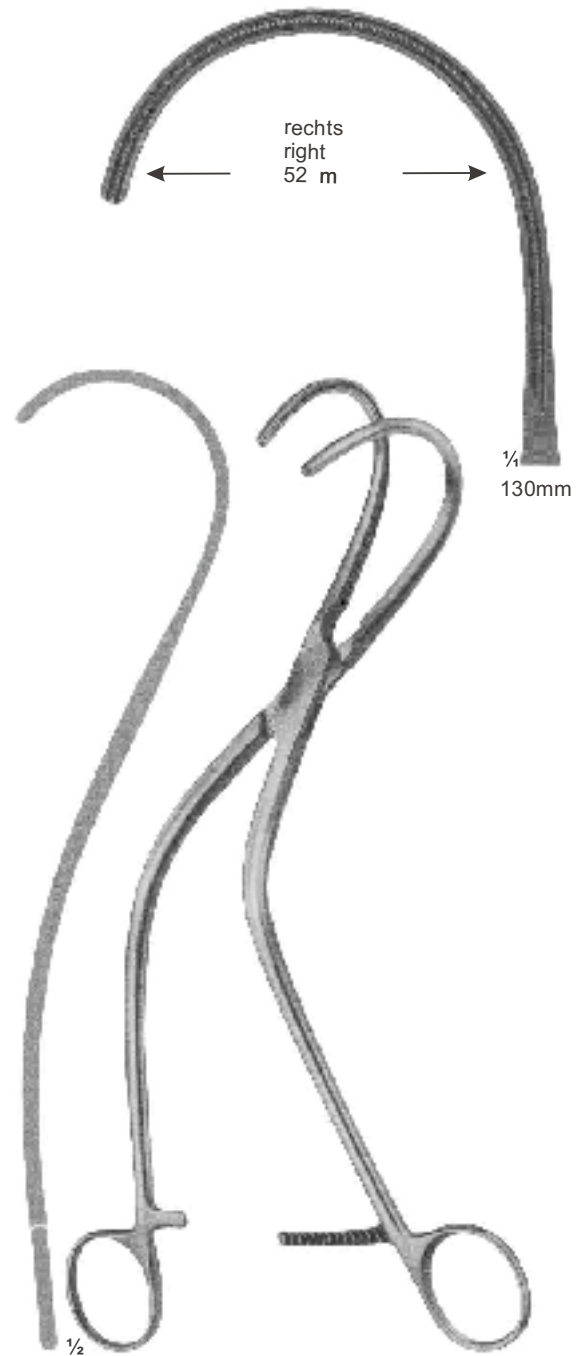

R
17-272
WEBER
265 mm

Aorta-Anastomosis Clamps



1/2
17-273 - 276
DE BAKEY

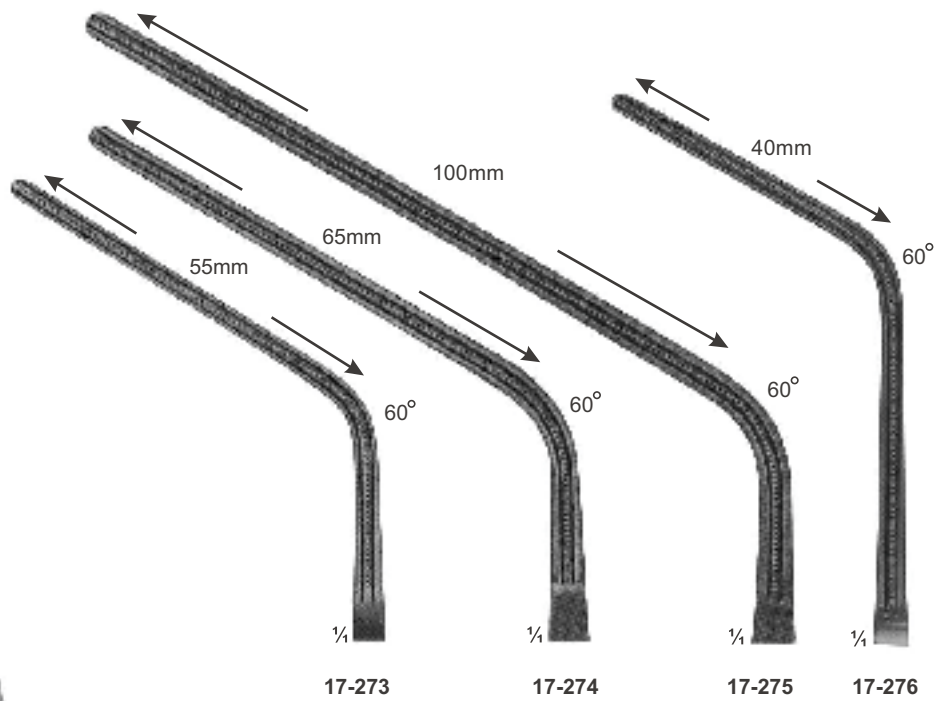

| | | | | |
|-----------------|--------|--------|--------|--------|
| Total Length: | 230 mm | 280 mm | 305 mm | 240 mm |
| Length of jaws: | 85 mm | 100 mm | 135 mm | 93 mm |



1/2
17-277 - 280
DE BAKEY

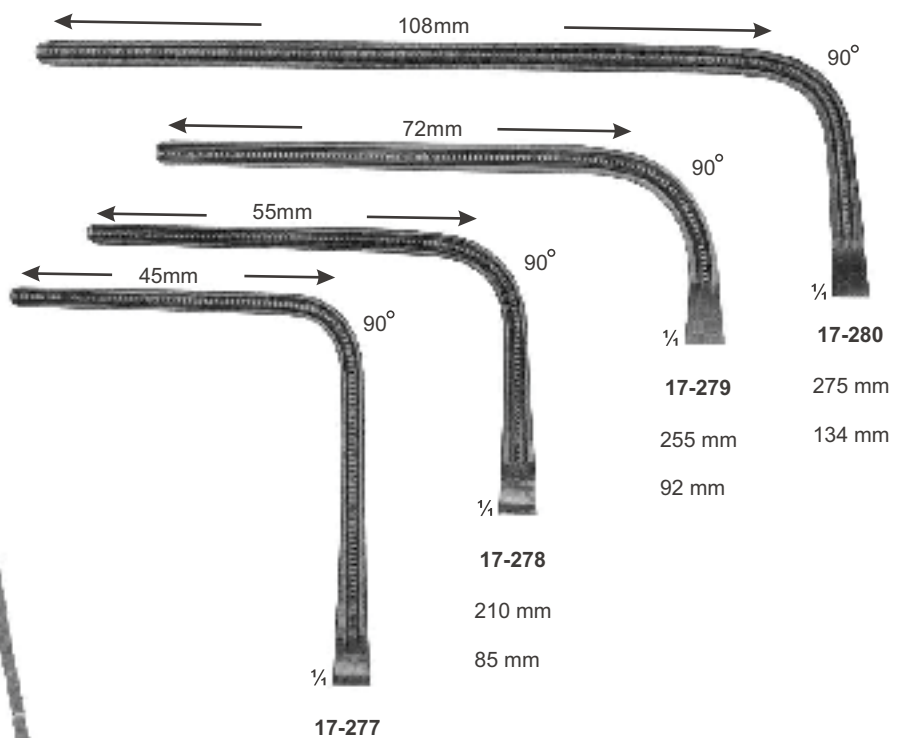

| | |
|-----------------|--------|
| Total Length: | 225 mm |
| Length of jaws: | 93 mm |

Aorta-Anastomosis Clamps

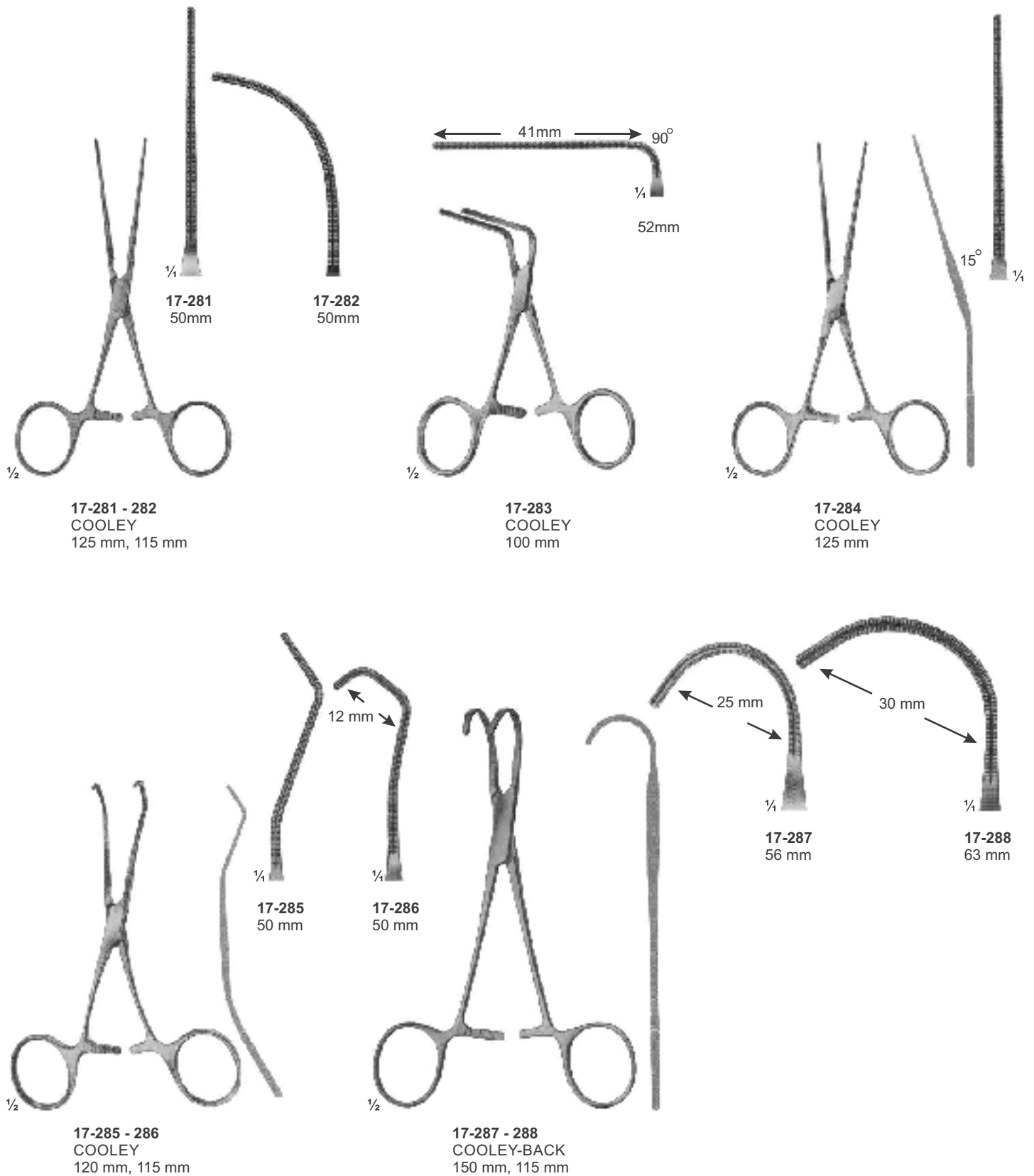

Aorta-Anastomosis Clamps

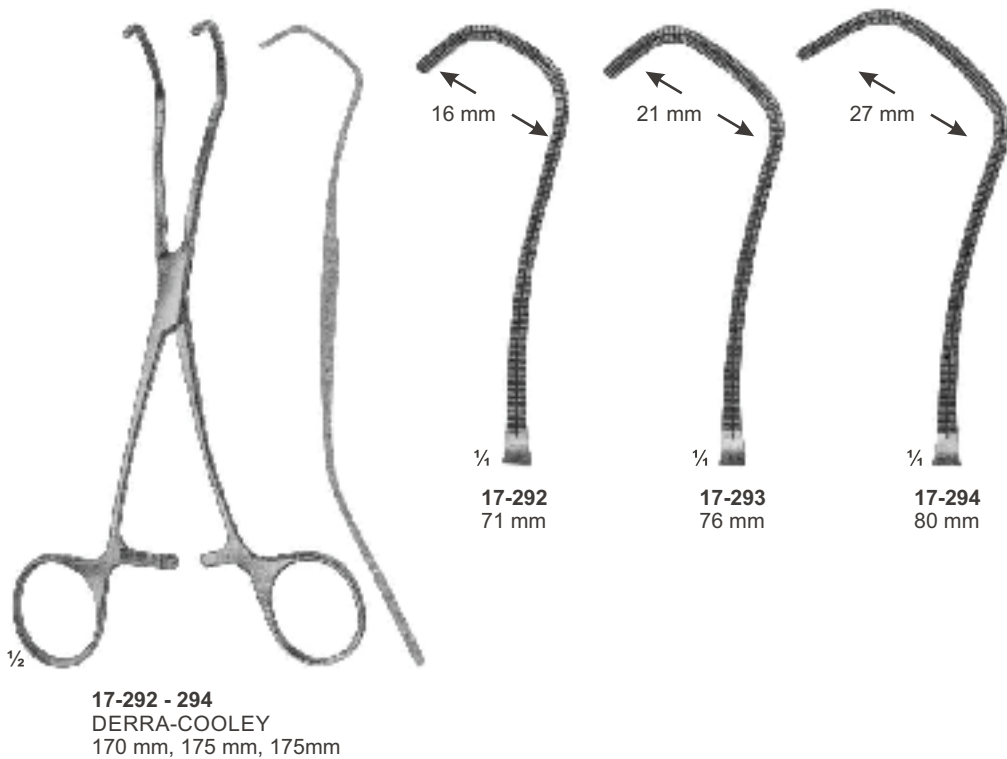
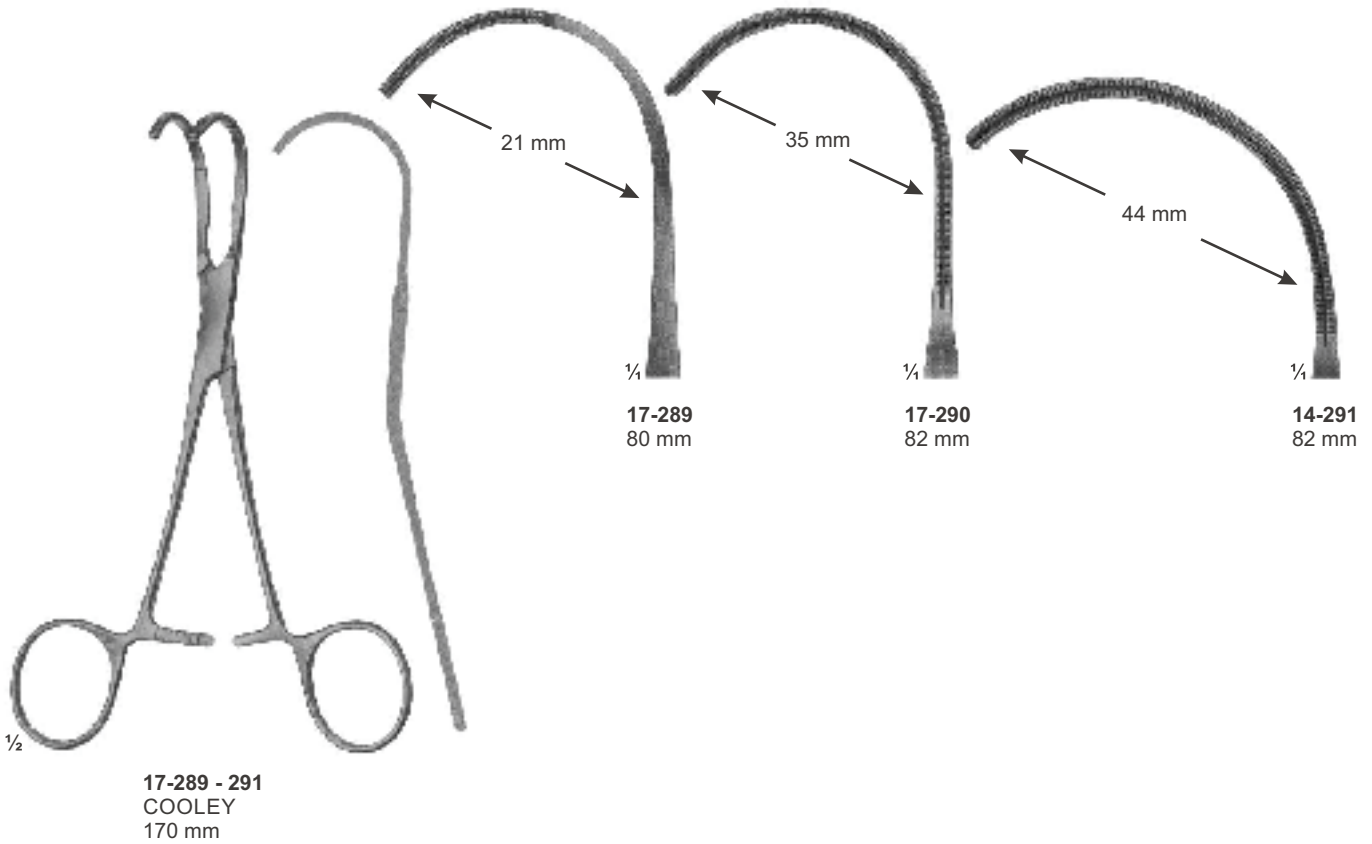

Aorta-Anastomosis Clamps

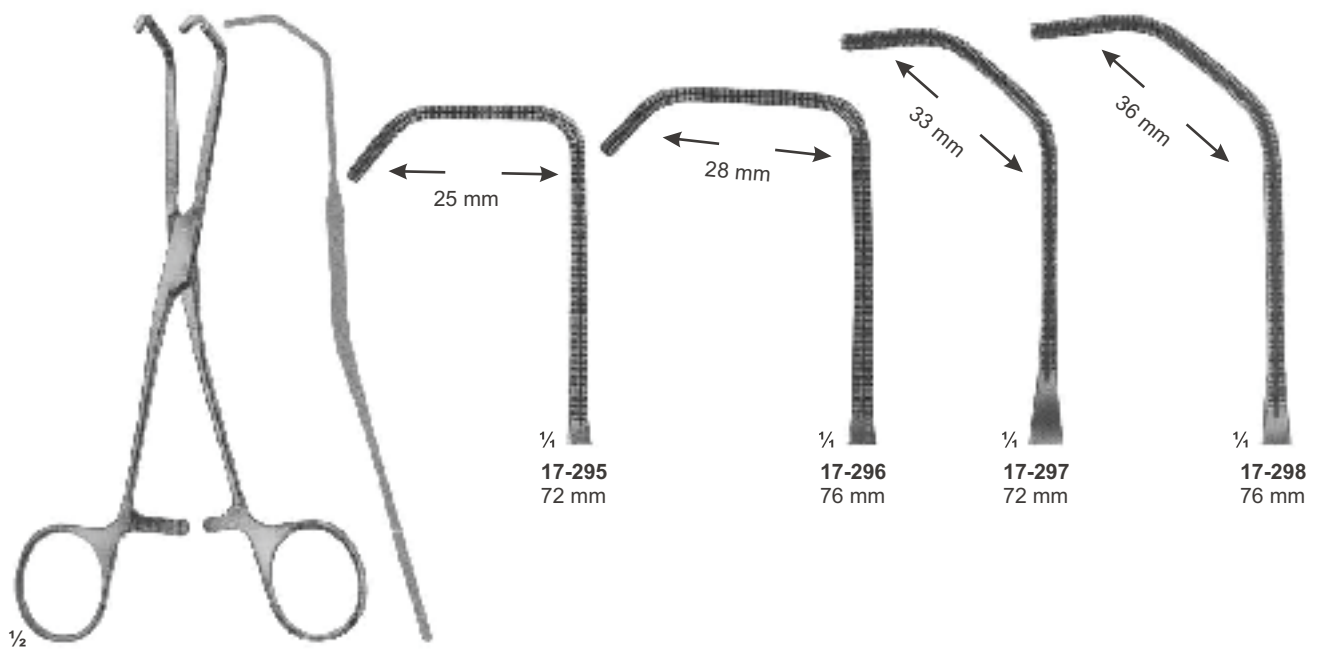

17-295 - 298
COOLEY
165 mm, 165 mm
175 mm, 180 mm

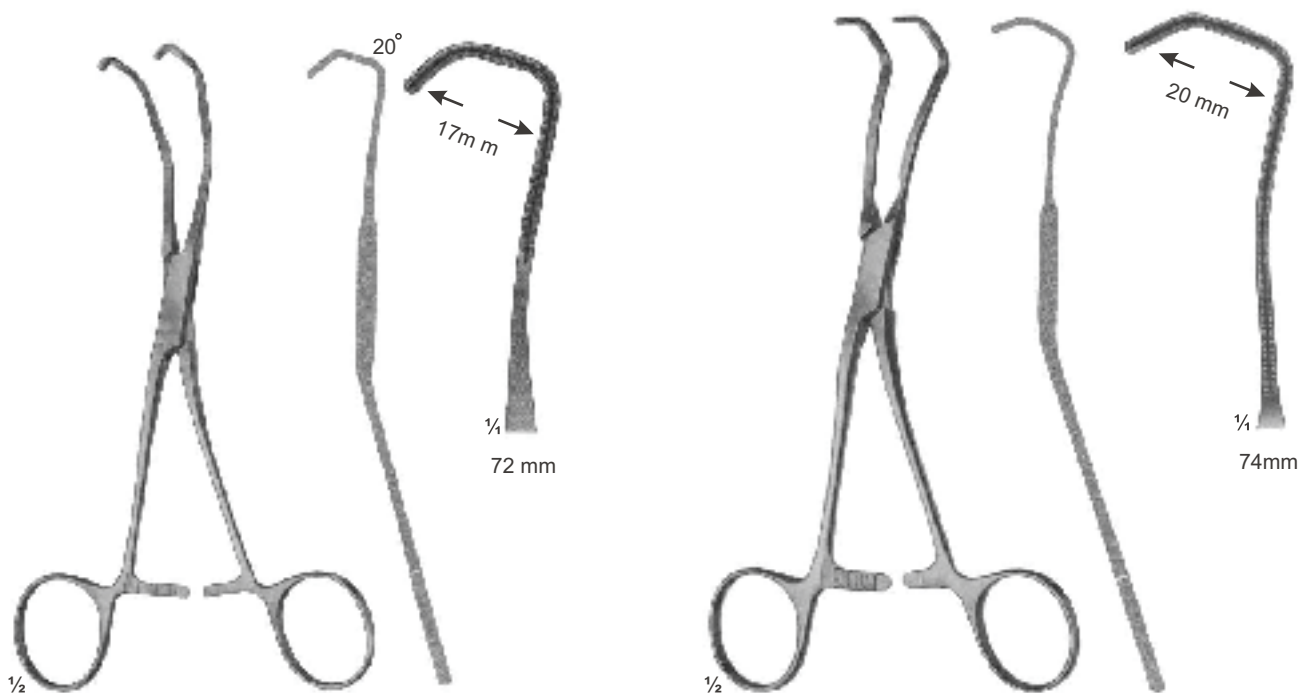

17-299
COOLEY
170 mm

17-300
COOLEY
175 mm

Aorta-Anastomosis Clamps

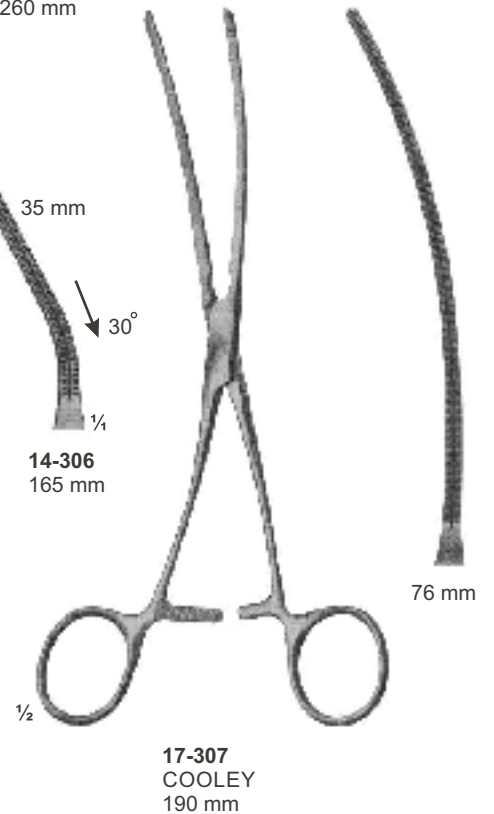
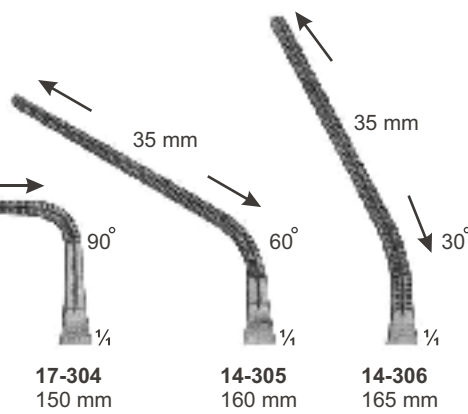
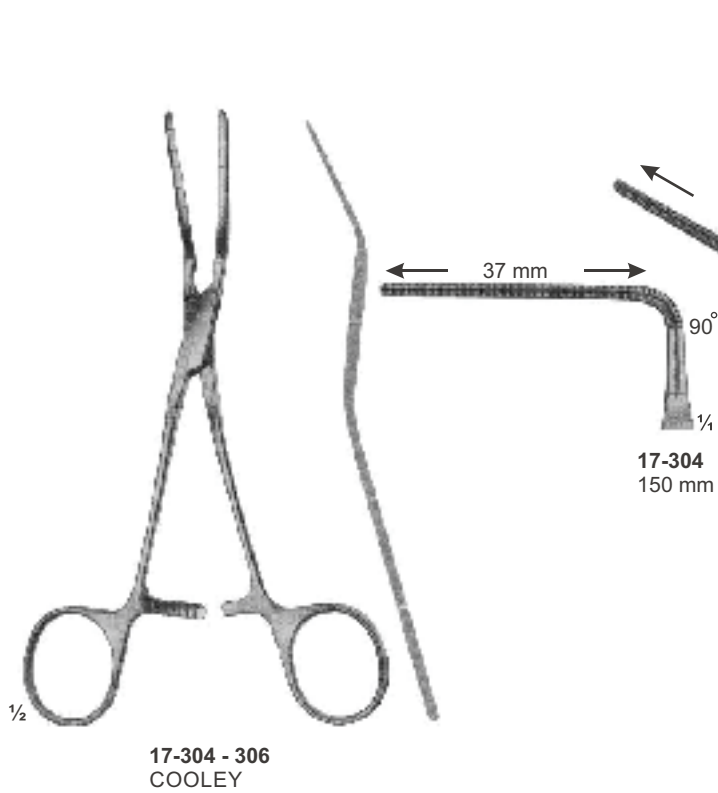
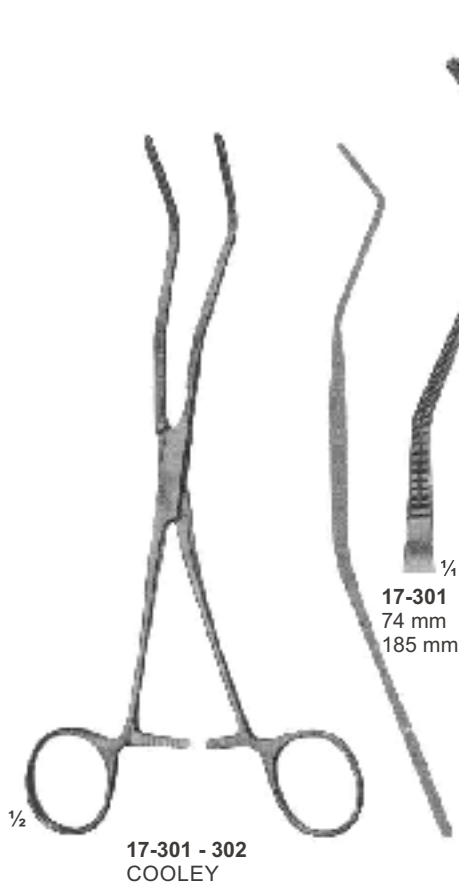

Aorta-Anastomosis Clamps

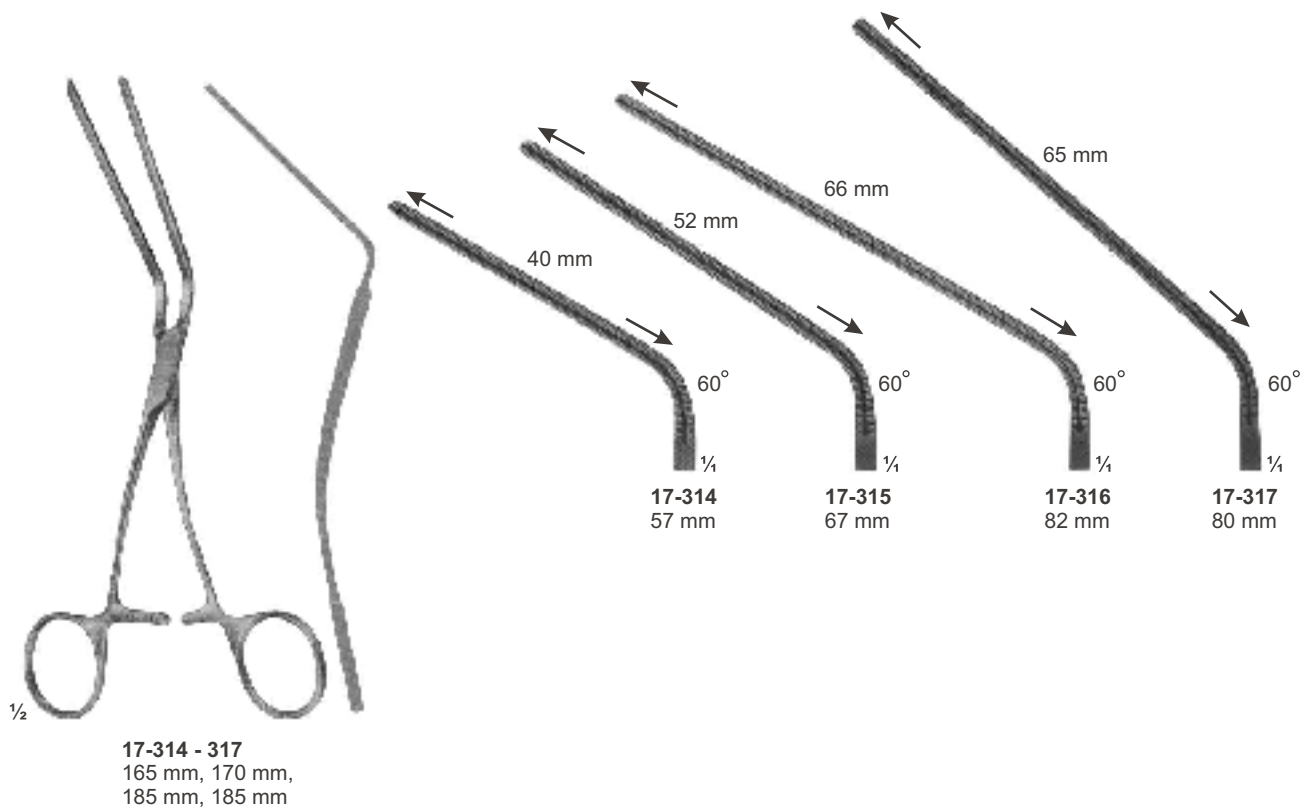
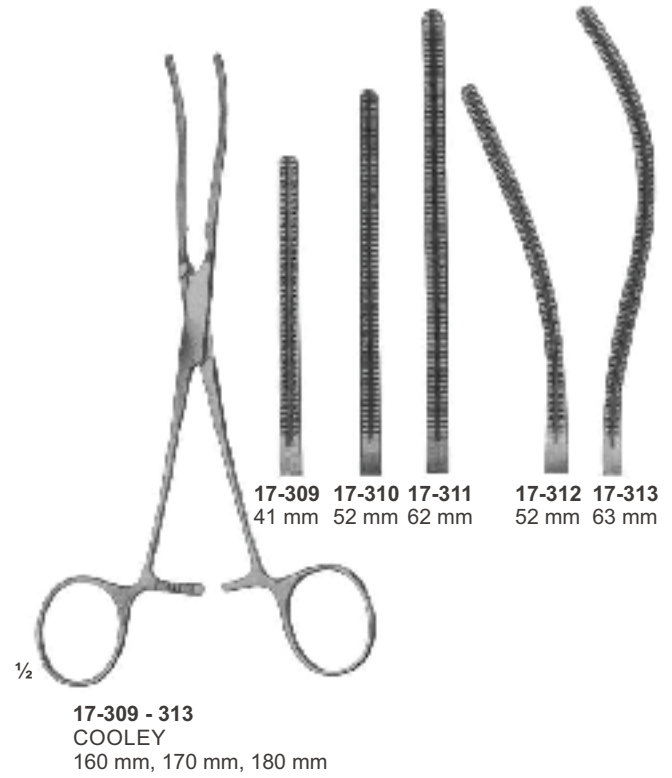
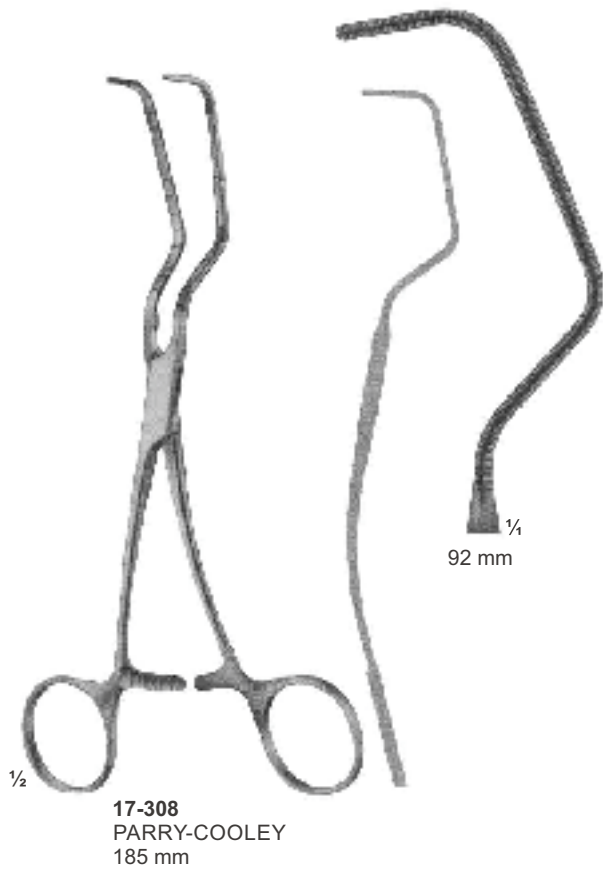

Multi-Purpose Clamps

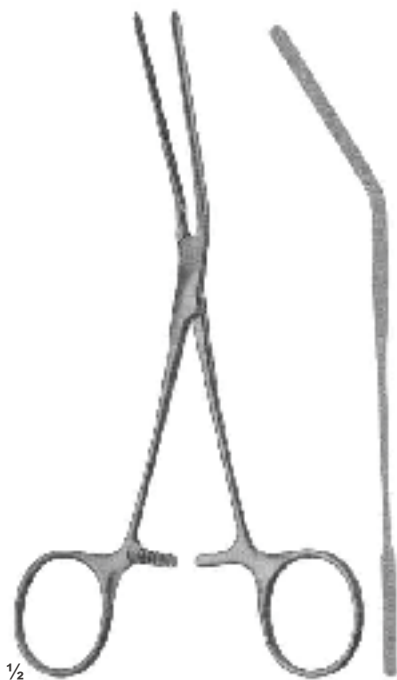

1/2

DARDIK

| | | | |
|--------|--------|--------|--------|
| 17-318 | 150 mm | 17-323 | 170 mm |
| 17-319 | 150 mm | 17-324 | 170 mm |
| 17-320 | 150 mm | 17-325 | 170 mm |
| 17-321 | 145 mm | 17-326 | 160 mm |
| 17-322 | 130 mm | 17-327 | 135 mm |

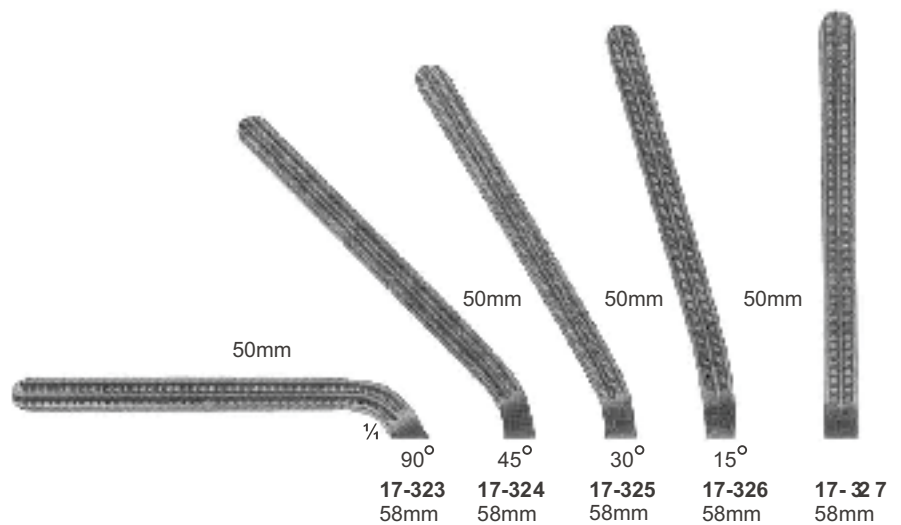
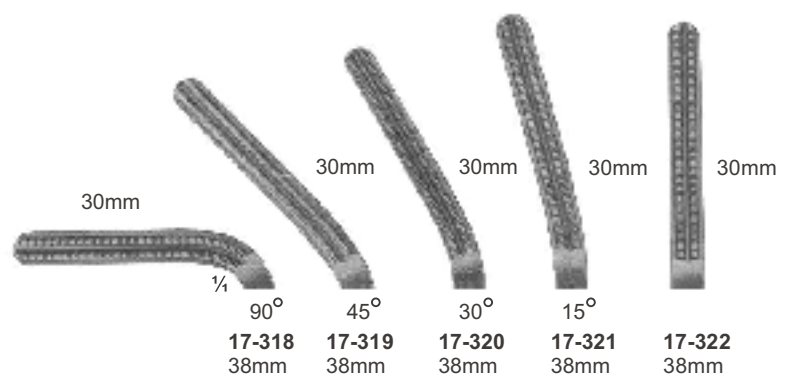

Multi-Purpose Clamps

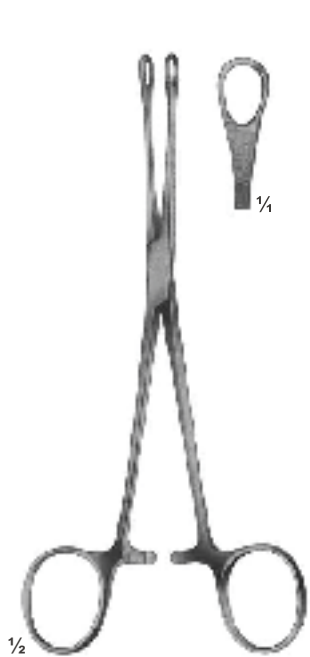

17-328
WILLIAMS
160 mm



17-329
TUTTLE
230 mm



17-330
NELSON
230 mm

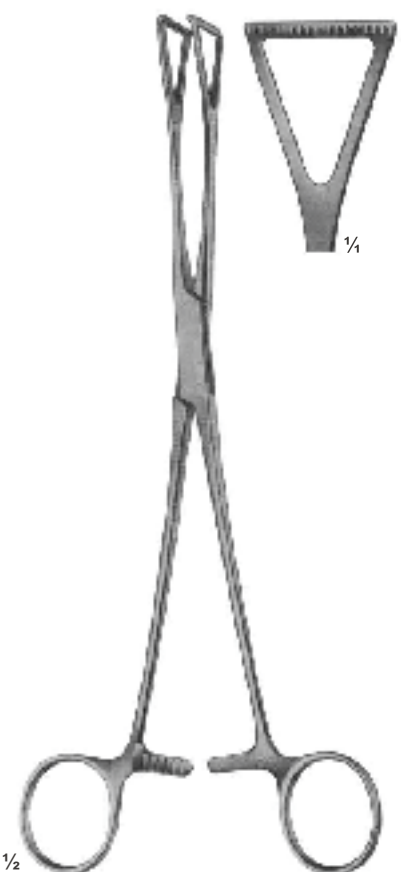

17-331
DUVAL
230 mm

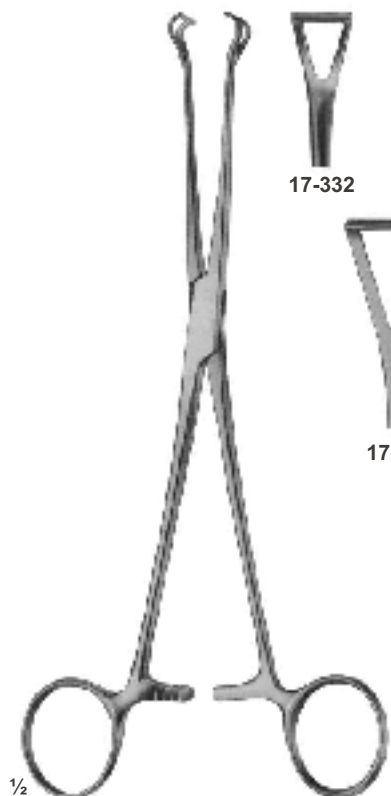

BABCOCK
17-332 170 mm
17-333 215 mm
17-334 220 mm



17-335
ALLIS
220 mm

Multi-Purpose Clamps

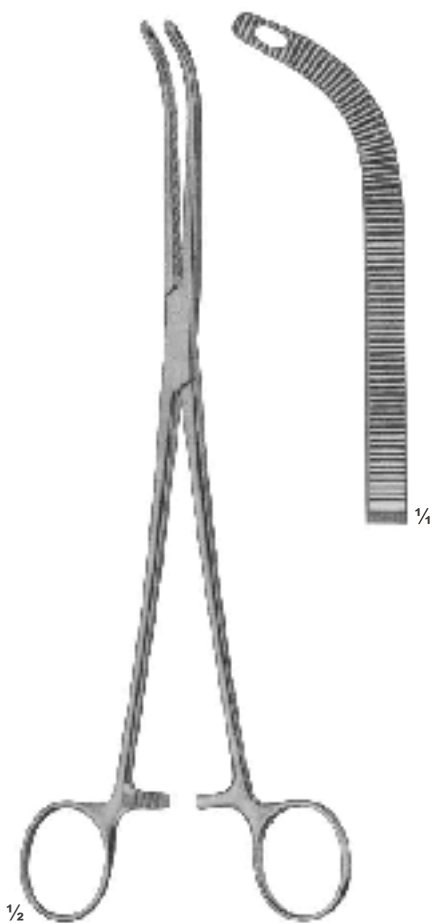

17-336
FINOCHIETTO
245 mm

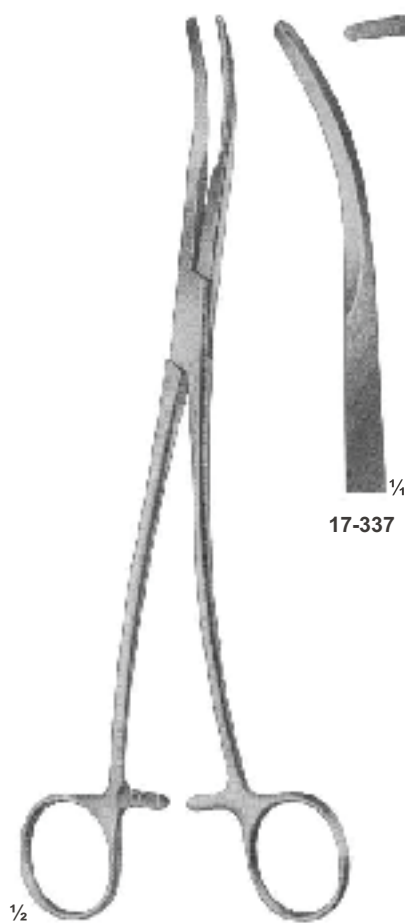

17-337

17-338

17-337 - 338
SEMB
244 mm

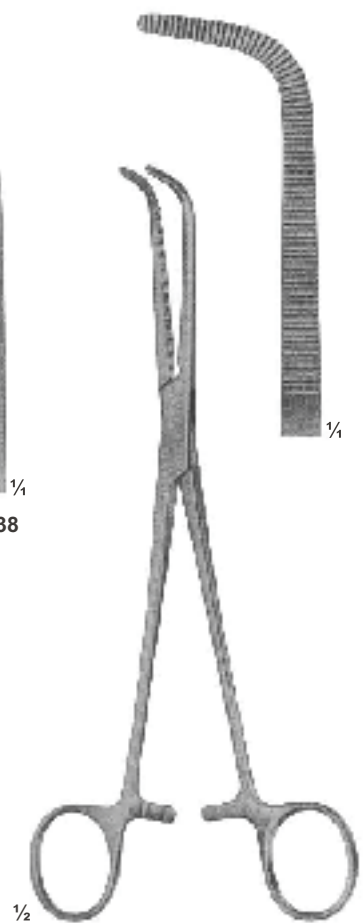

17-339
WIKSTROEM
205 mm

Multi-Purpose Clamps

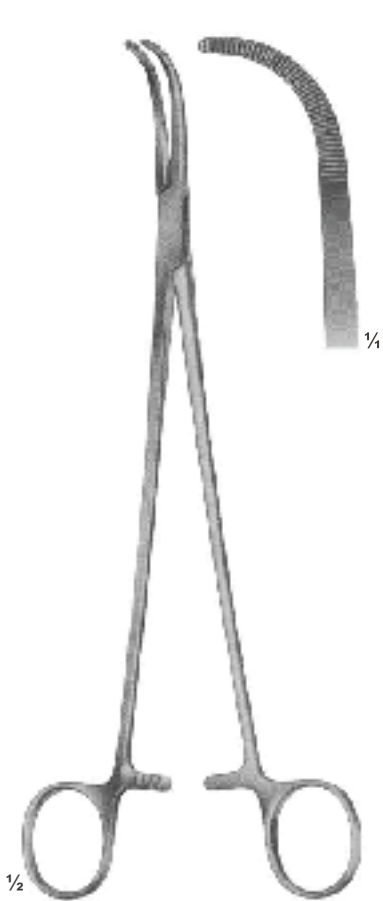

17-340
MIXTER
230 mm

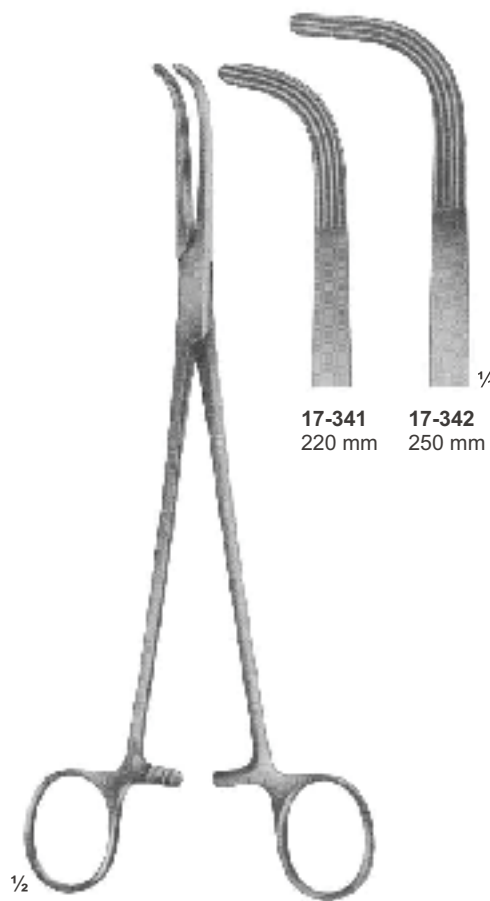

17-341 220 mm
17-342 250 mm

17-341 - 342
MIXTER

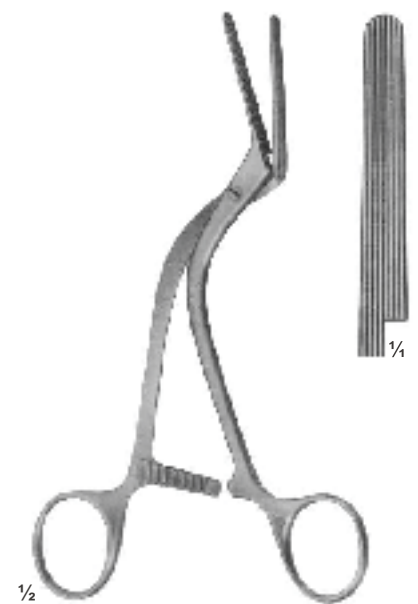

17-343
HOPFNER
160 mm

Multi-Purpose Clamps

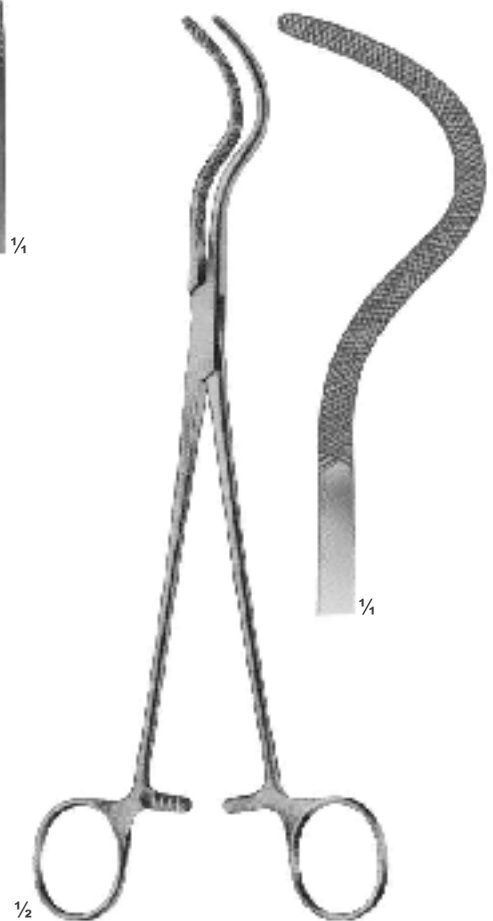
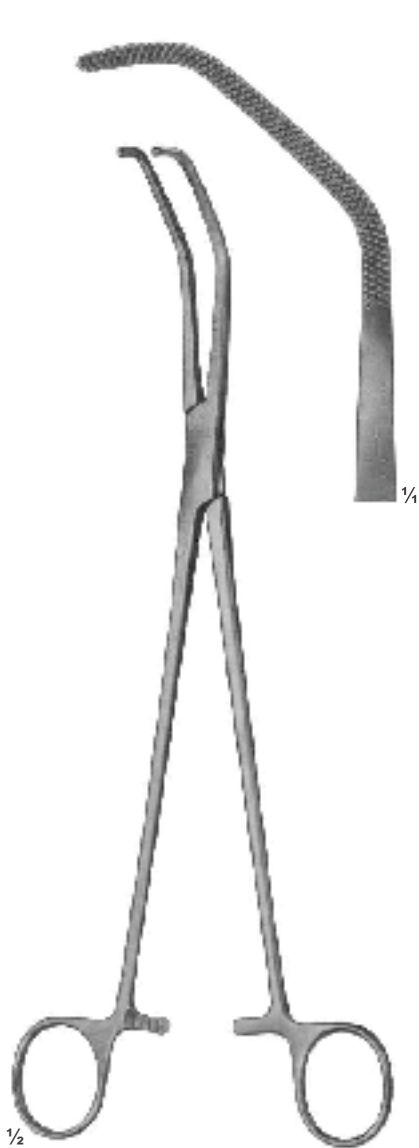

Multi-Purpose Clamps



17-347
PERTUISET
Carotid Clamp
90 mm

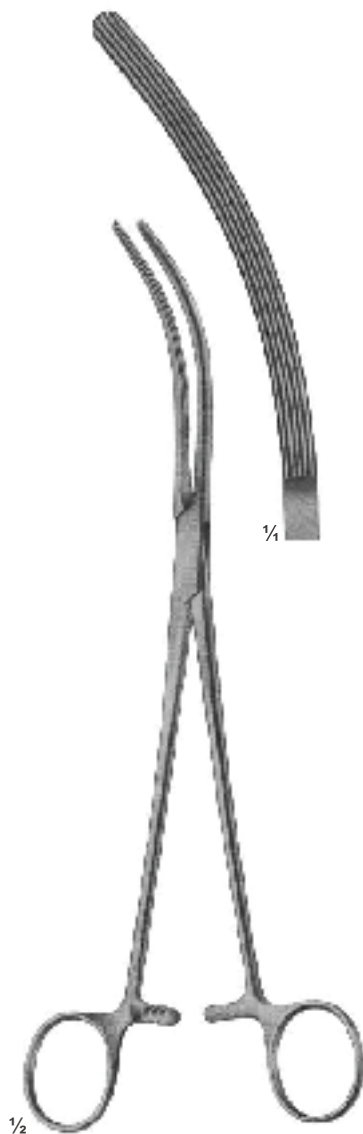

17-348
CRAFOORD-SELLORS
240 mm

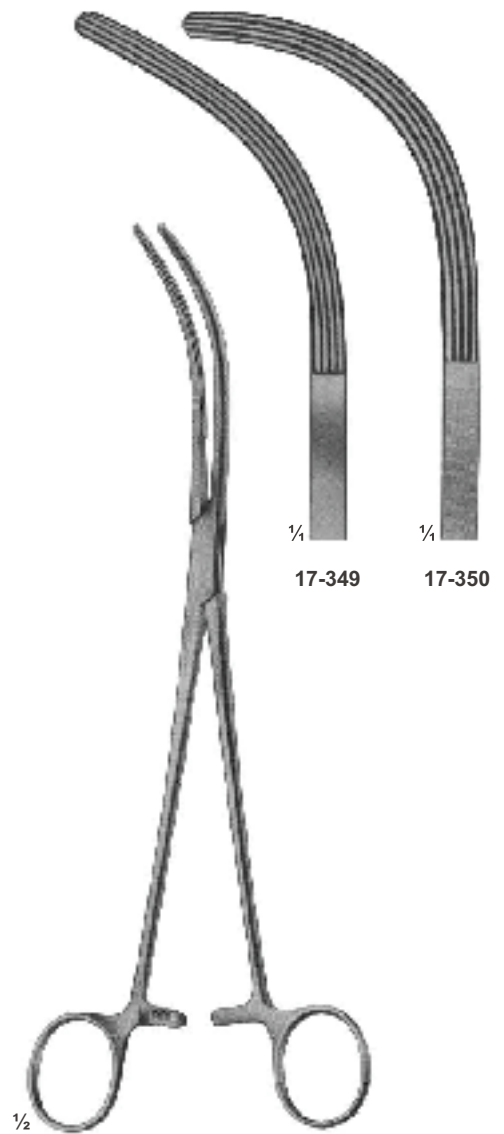

17-349 - 350
CRAFOORD
240 mm

Multi-Purpose Clamps



17-351
PRICE THOMAS
225 mm



17-352
jaws with pins

17-353
jaws with pins

17-352 - 353
PRICE THOMAS
225 mm

Rib Shears

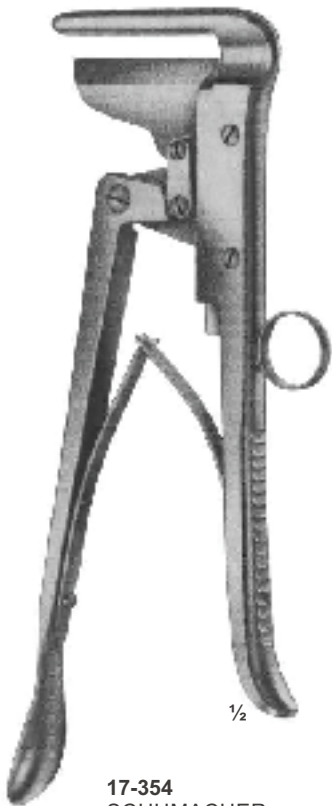

17-354
SCHUMACHER
Sternum shears
210 mm



17-355
LEBSCHKE
Sternum chisel
200 mm



17-356
230 mm



17-357
COLLIN
195 mm



17-358
GLUCK
190 mm



17-359
GLUCK
190 mm



17-360
BRUNNER
Universal Pattern
340 mm



17-361
GIERTZ-STILLE
250 mm

Rib Holding Forceps, Bone Cutting Forceps

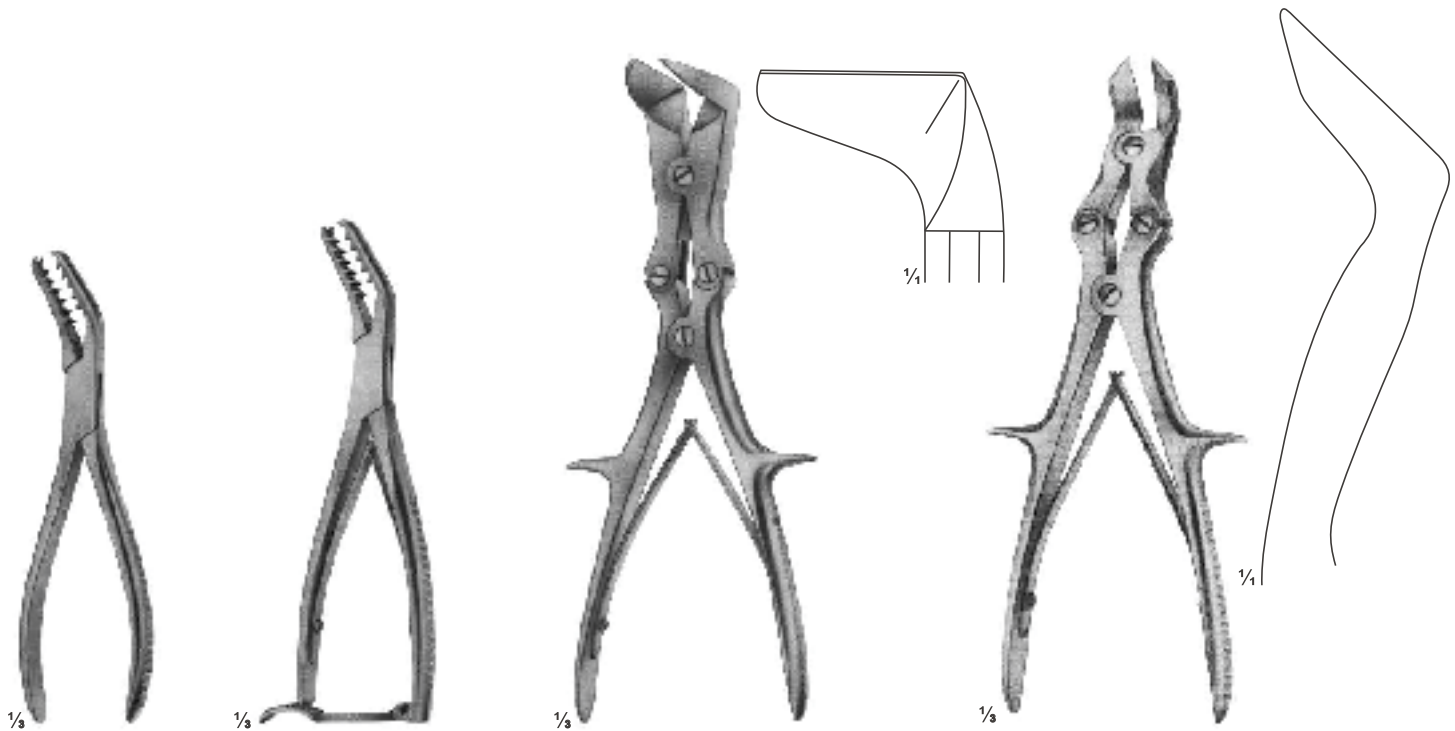

17-362
SEMB
Rib-and Bone
Holding forceps
190 mm

17-363
SEMB
Rib-and Bone
Holding forceps
190 mm

17-364
LISTON-STILLE
265 mm

17-365
LISTON-KEY-HORSLEY
255 mm

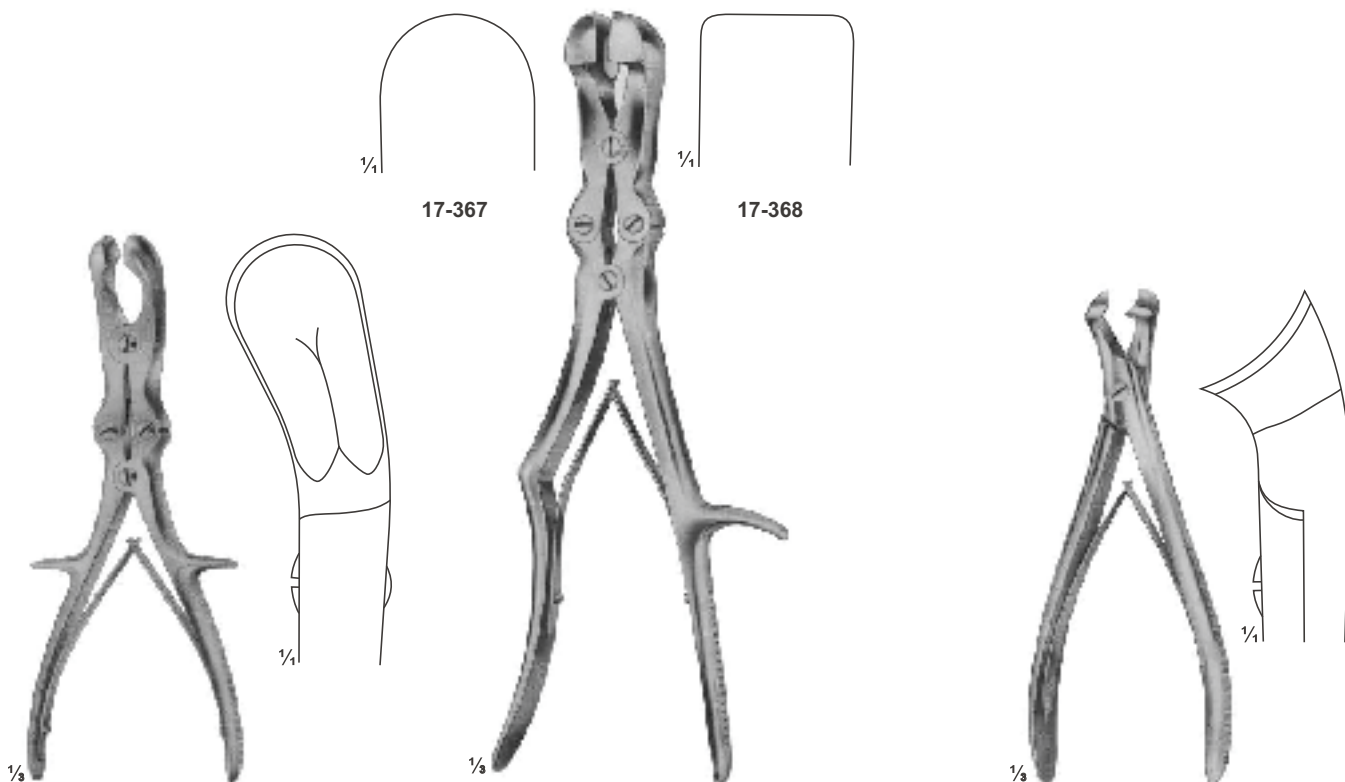

17-366
SEME
Rib Rongeur to shorten
the rib stumps
240 mm

17-367-368
SAUERDRUCH-CORYLLOS
Rib rongeurs to shortn
the rib stumbes
310 mm

17-369
MARKWALDER
Rib Rongeur to Round
the rib stumps
190 mm

Rib Raspatories

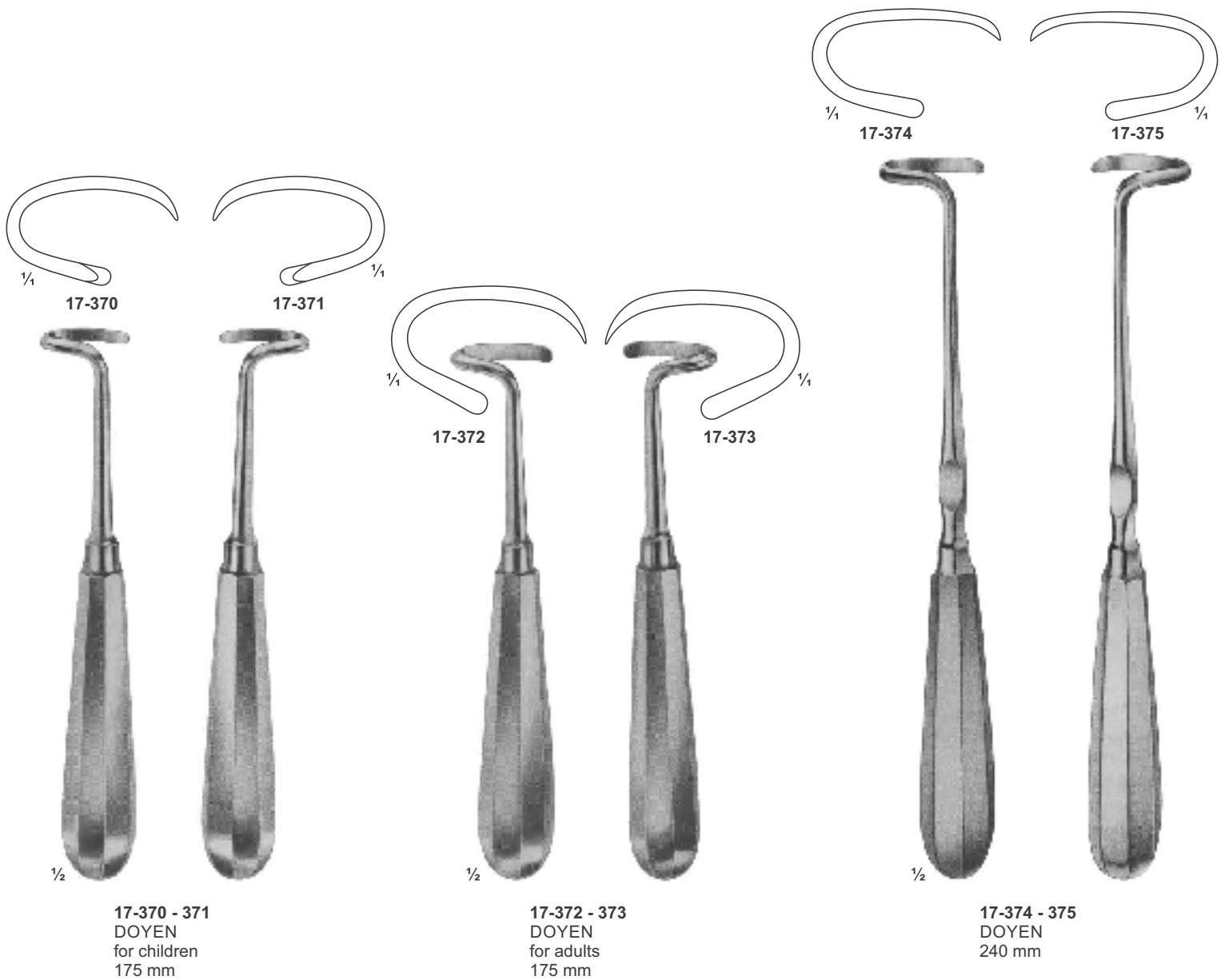

17-370 - 371
DOYEN
for children
175 mm

17-372 - 373
DOYEN
for adults
175 mm

17-374 - 375
DOYEN
240 mm

Rib Raspatories

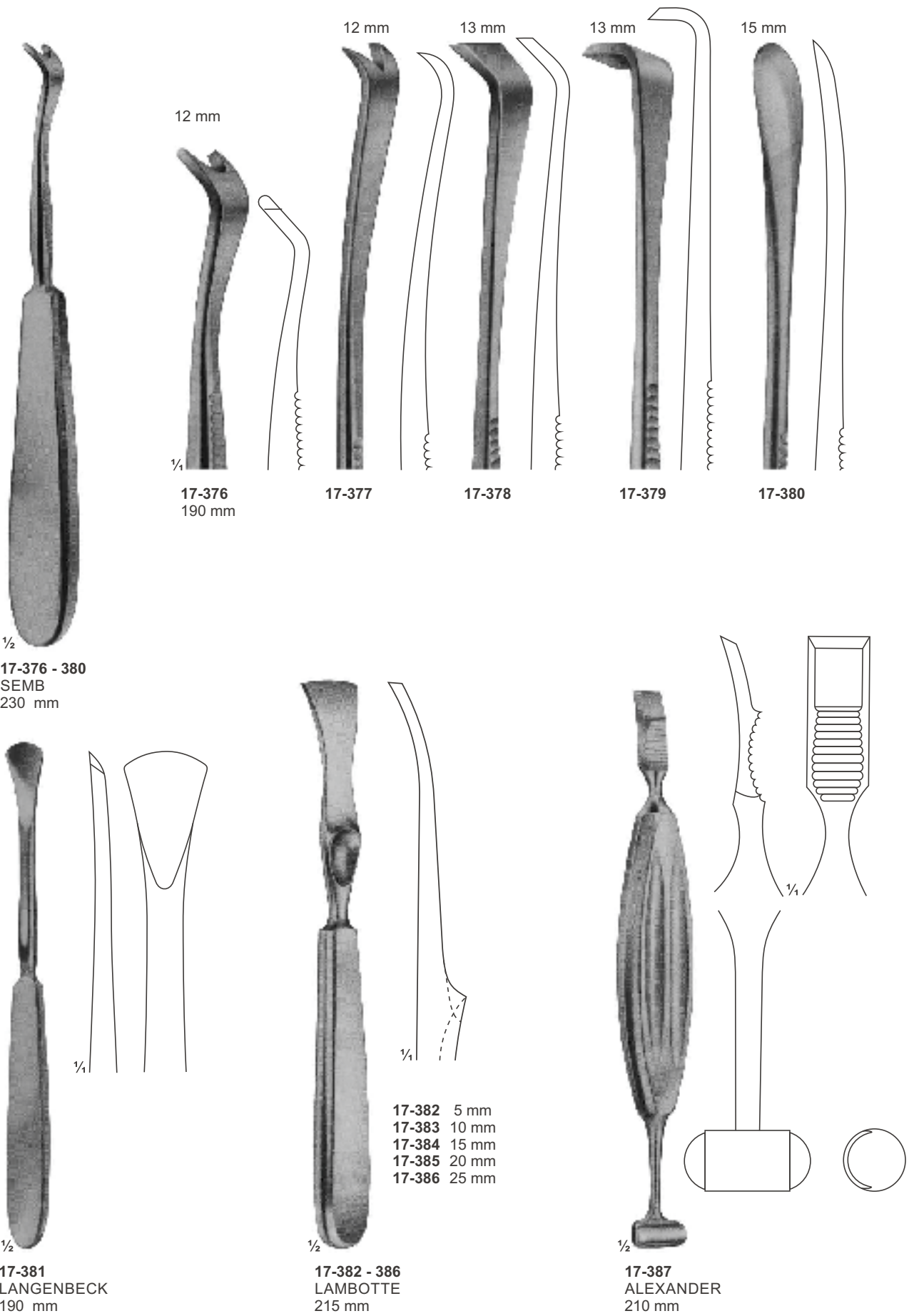

Rib Spreaders

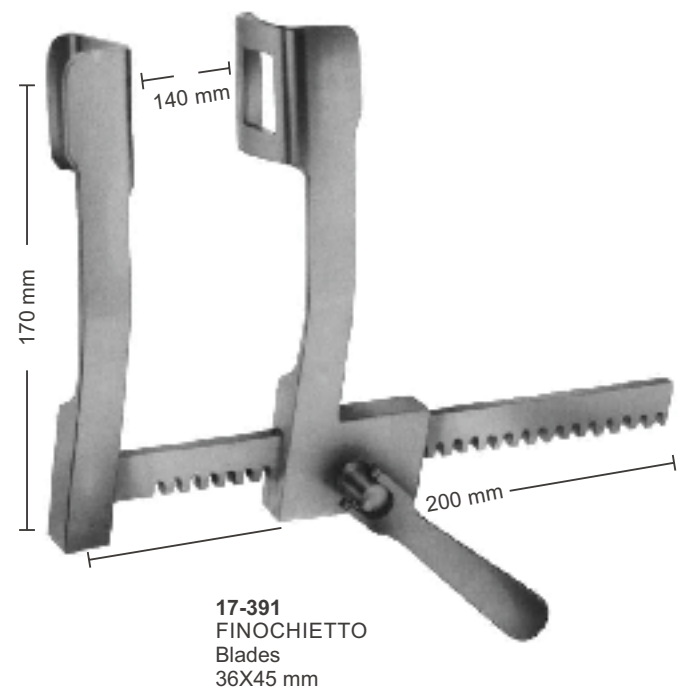
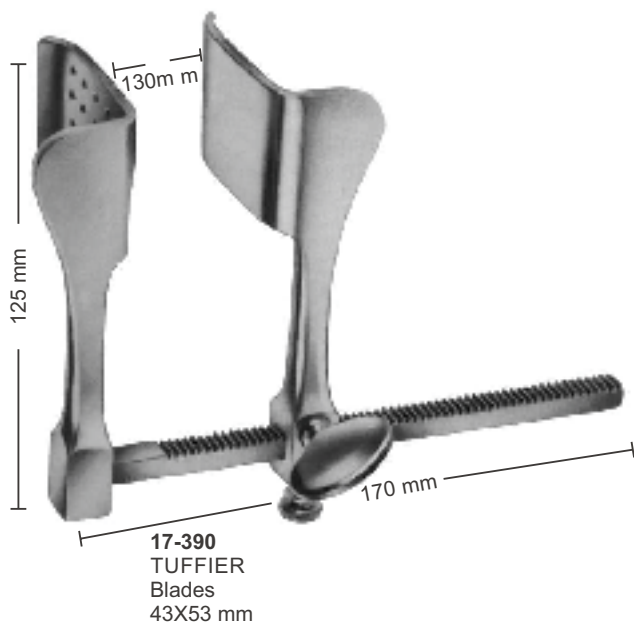
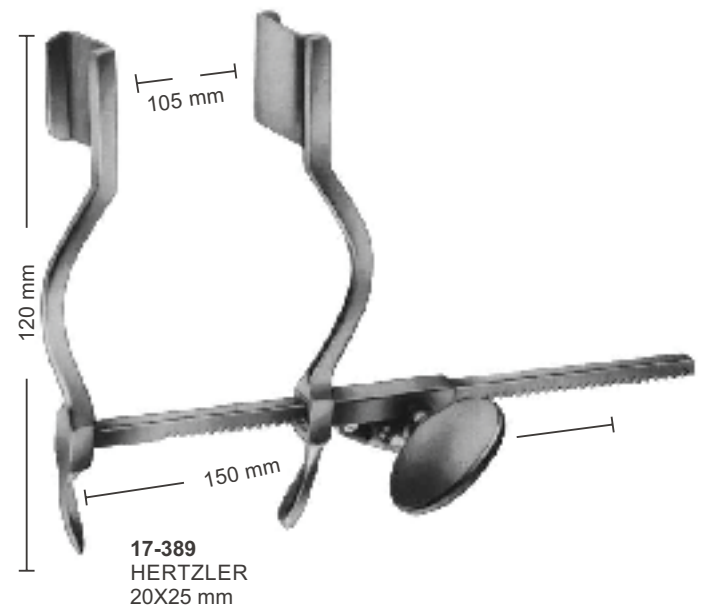
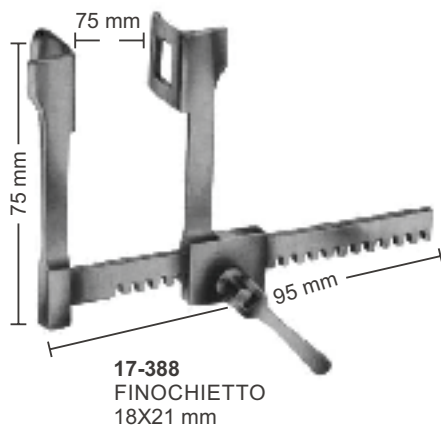

Rib Spreaders

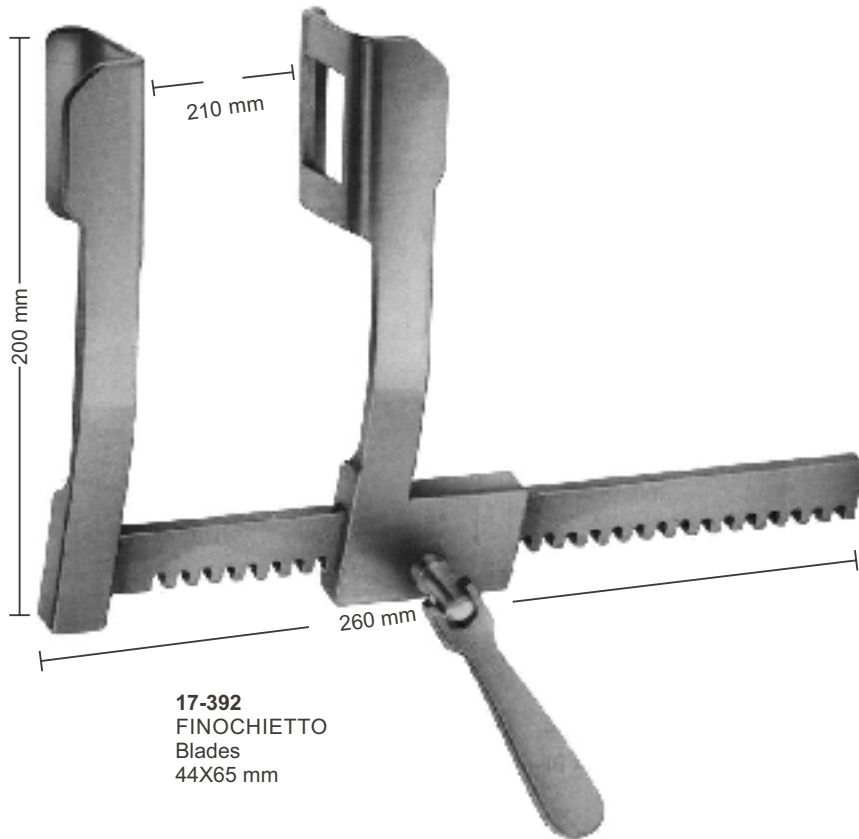

17-392
FINOCHIETTO
Blades
44X65 mm

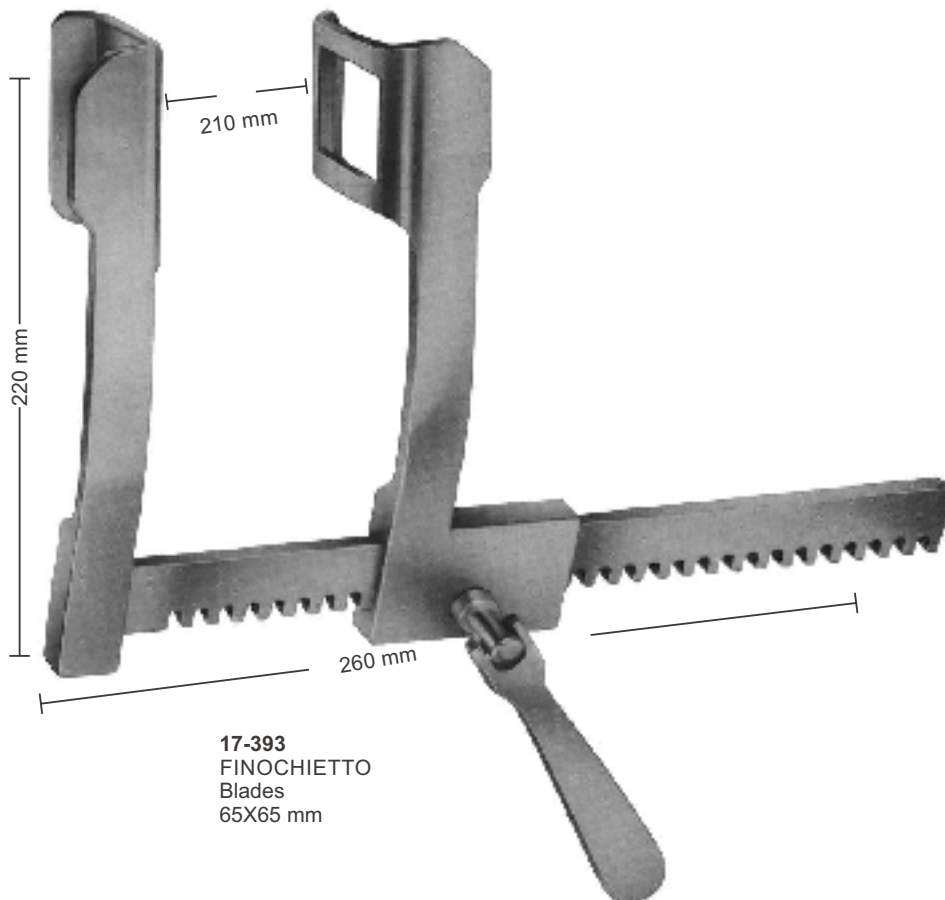

17-393
FINOCHIETTO
Blades
65X65 mm

Rib Spreaders

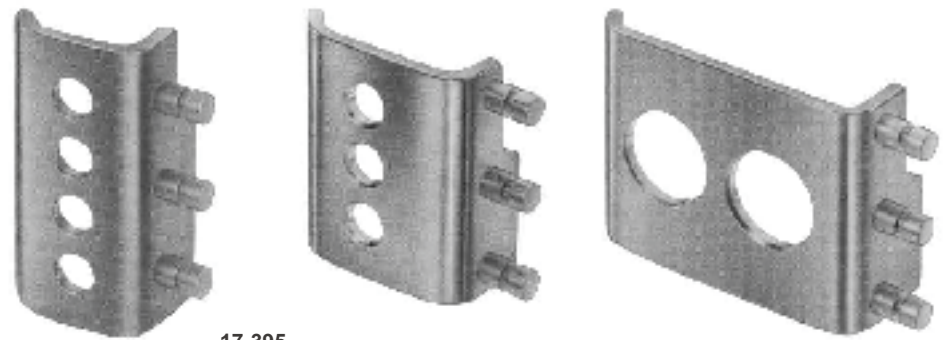

17-395
Blades
46x67 mm

17-397
Blades
46x67 mm

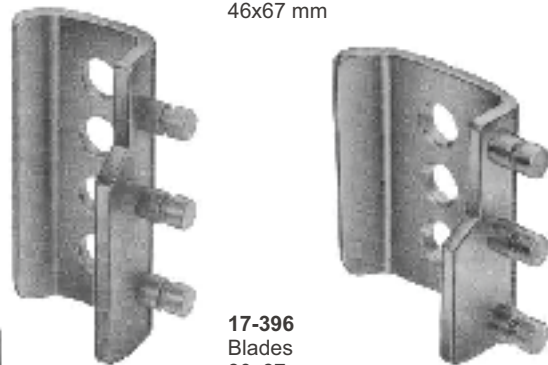

17-396
Blades
80x67 mm



17-398
Blade, Only, for preparation
of a. Mammaria, 25.5x80mm

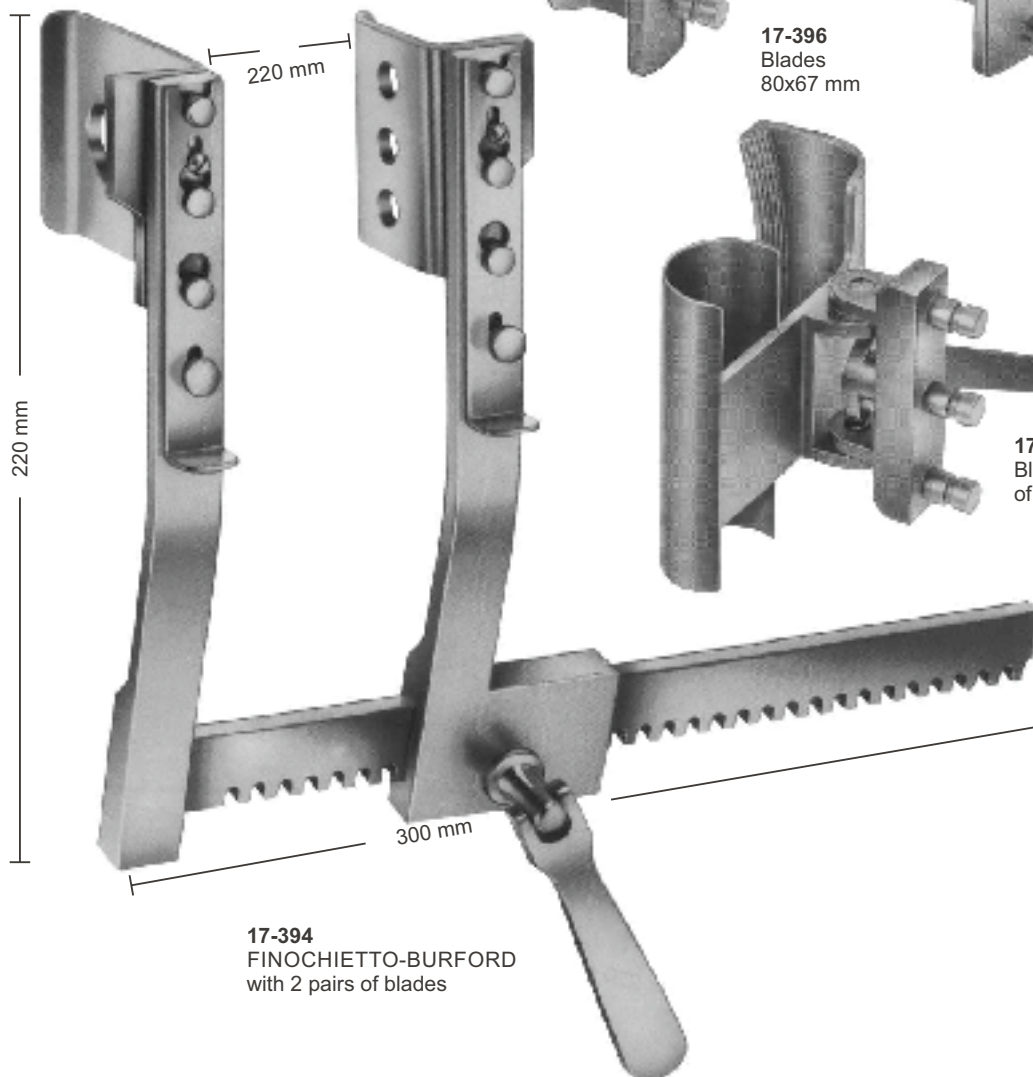

17-394
FINOCHIETTO-BURFORD
with 2 pairs of blades

Rib Spreaders

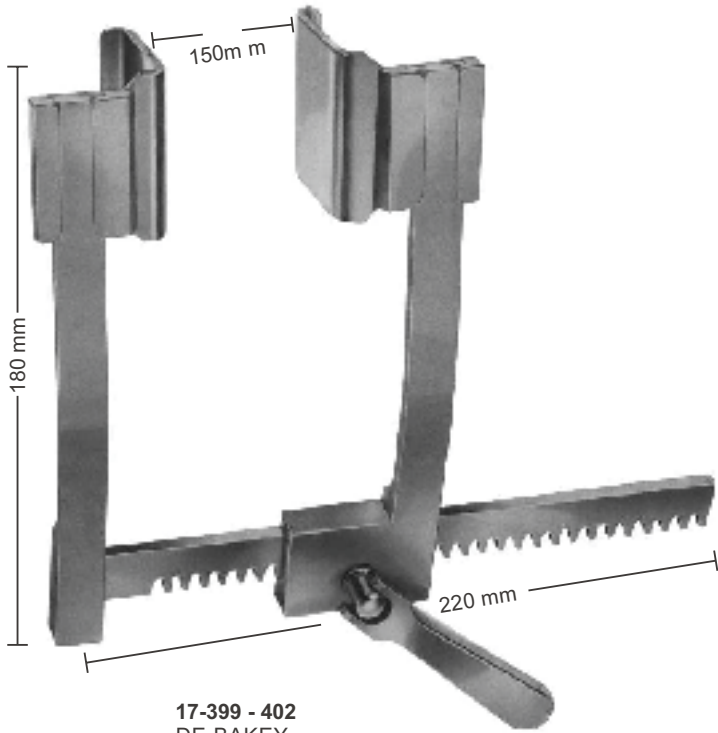

17-399 - 402
DE-BAKEY
with 3 pairs of blades

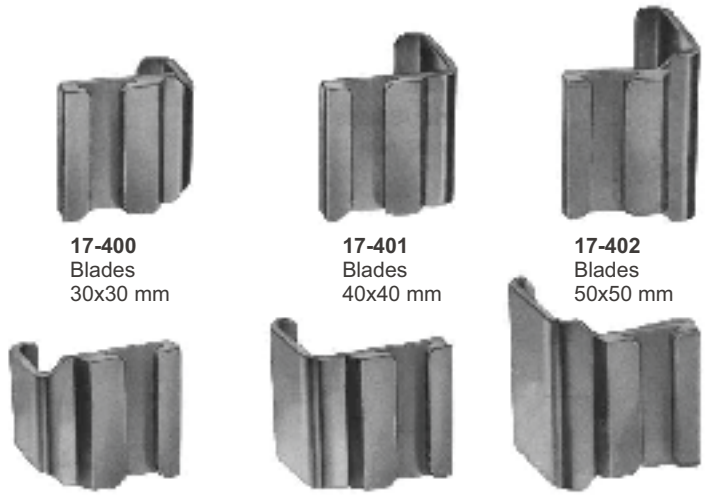

17-400
Blades
30x30 mm

17-401
Blades
40x40 mm

17-402
Blades
50x50 mm

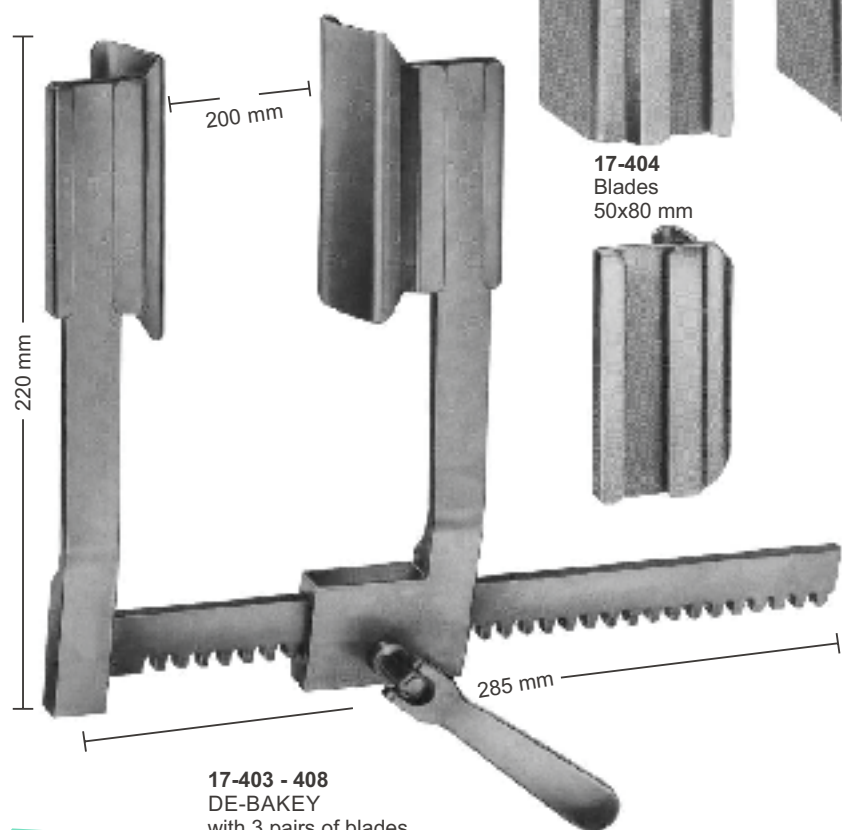

17-403 - 408
DE-BAKEY
with 3 pairs of blades

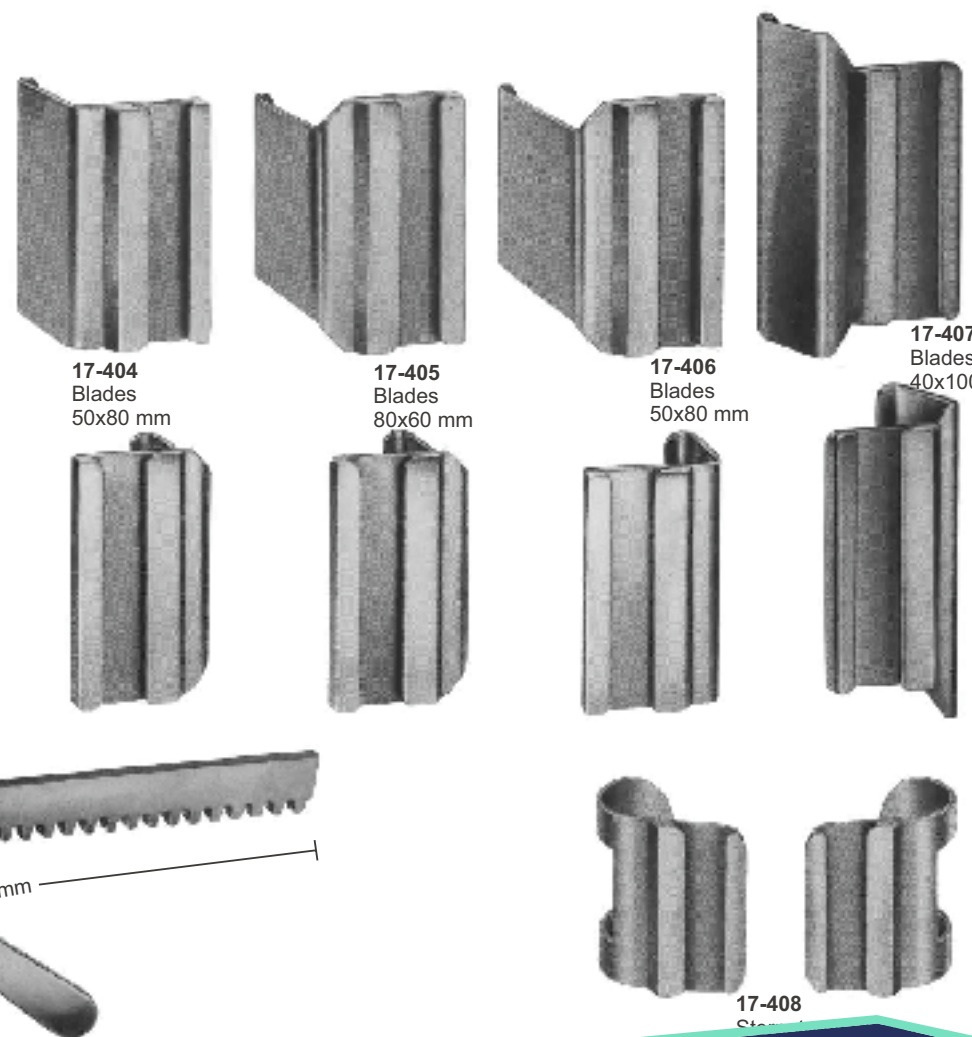

17-404
Blades
50x80 mm

17-405
Blades
80x60 mm

17-406
Blades
50x80 mm

17-407
Blades
40x100 mm

17-408
Blades

Sternotomy Spreaders

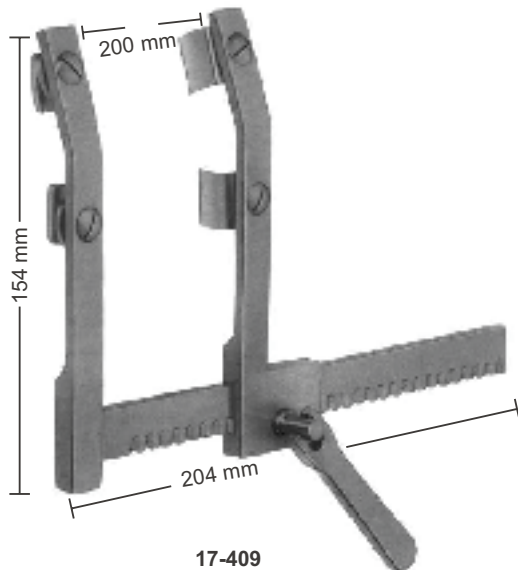

17-409
MORSE
Sternotomy spreader
for children, with moveable
double, each blade
12x20 mm

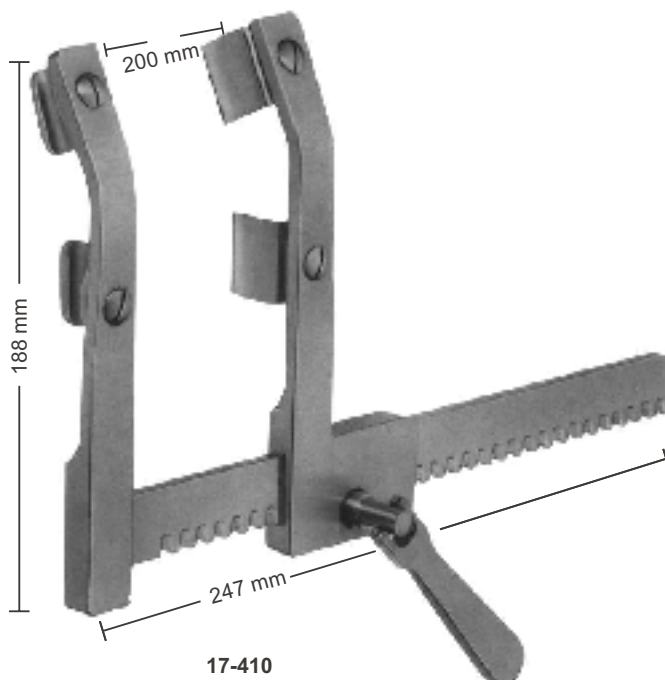

17-410
MORSE
Sternotomy spreader
for adults, with moveable
double, each blade
19x19 mm

Sternotomy- Spreaders

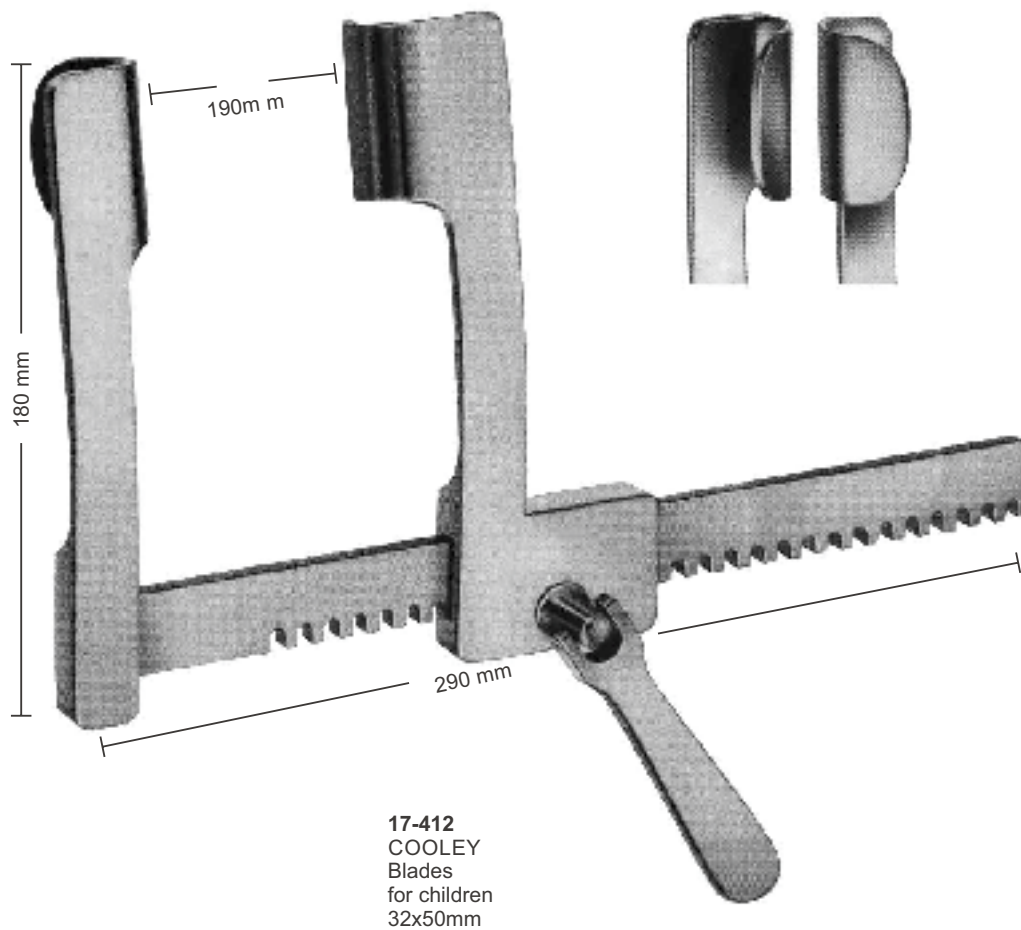
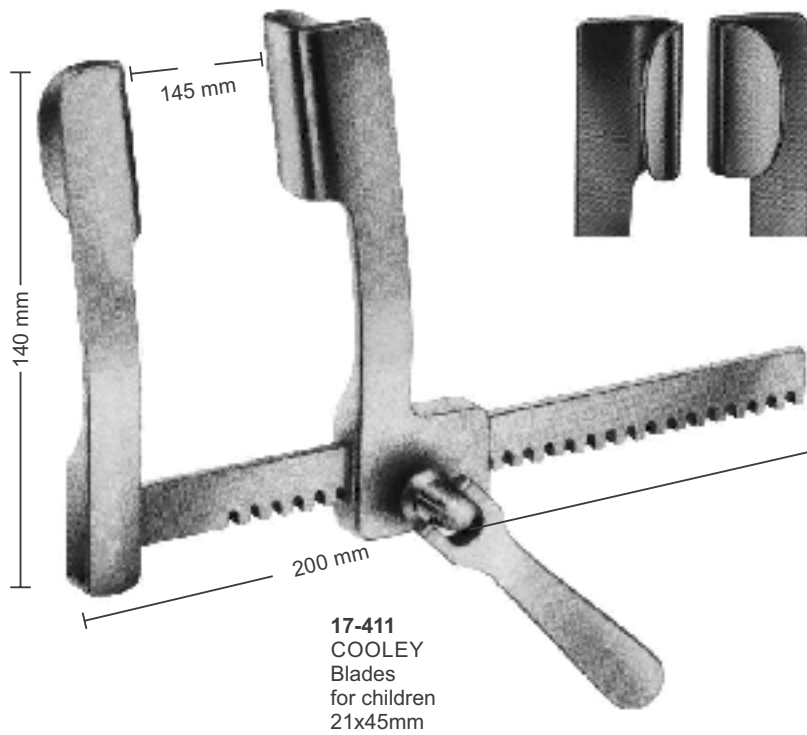

Thoracic Retractors



17-414
Blades
75x75 mm



17-415
Blades
42x65 mm

Blades with Ball Snap System
Delivery: in Pairs

- 17-413 - 415**
Thoraxsperrer (Mercedes-Sperrer)
complete consisting of:
17-413 Retractor only
17-414 1 Pair of blades 42x65 mm
17-415 1 Pair of blades 75x75 mm

Rib Spreaders-and Contractors



1/2

17-416
SELLORS
Rib spreader-and contractor
with swivel blades
200 mm



1/2

17-417
BAILEY
150 mm

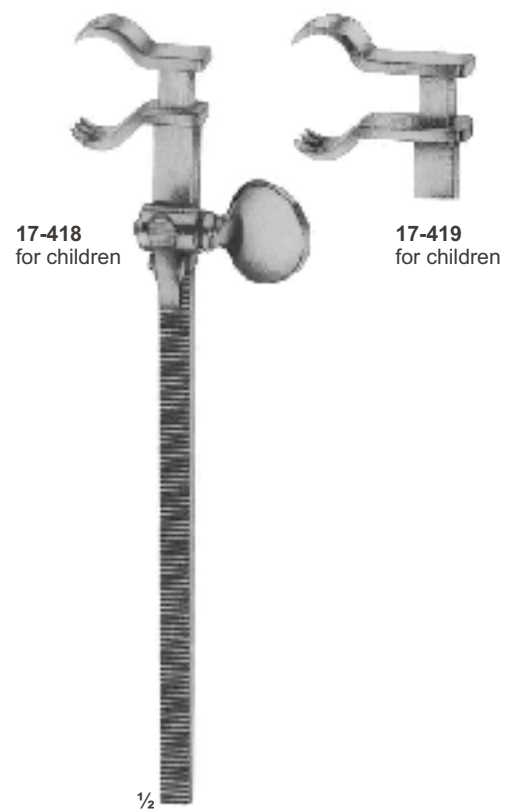

17-418
for children

17-419
for children

1/2

17-418 - 419
BAILEY
200 mm

Rib Spreaders-and Contractors

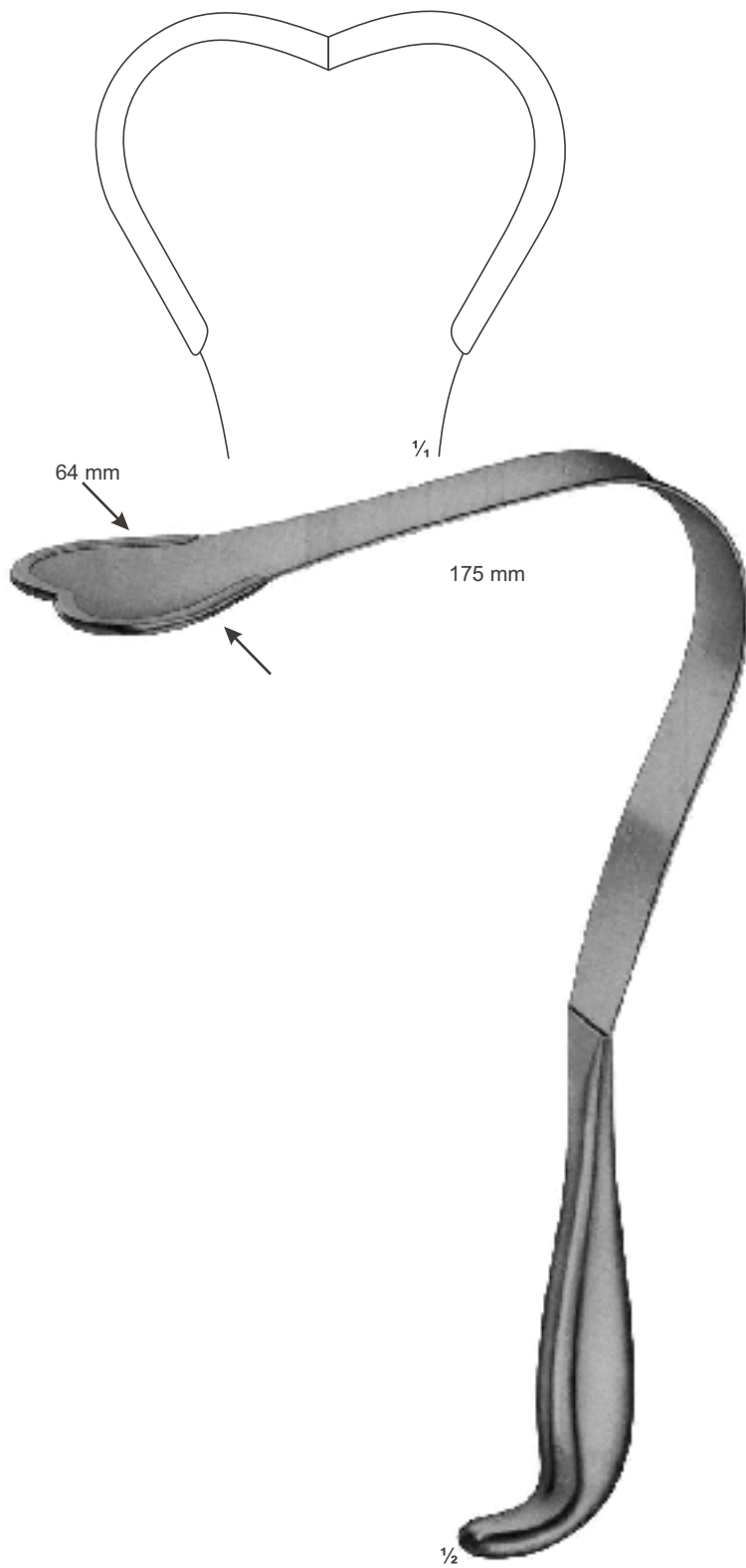

17-420
HARRINGTON-PEMBERTON
federnd/flexible
295 mm

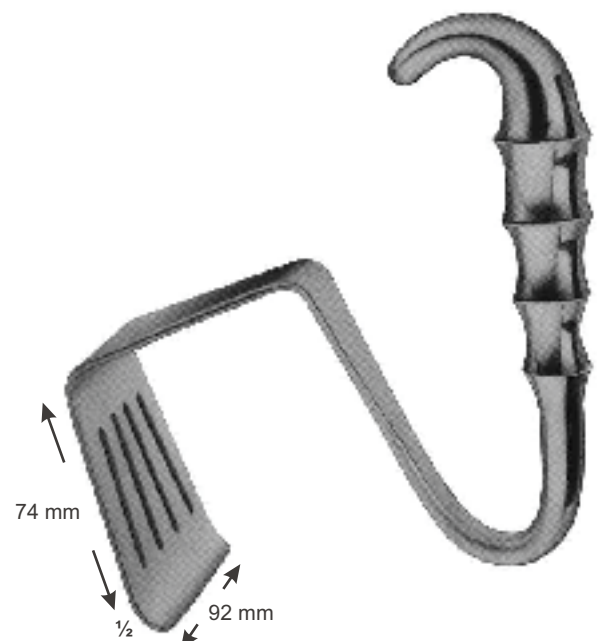

17-421
DAVIDSON
Scalpel haken

Rib Spreaders-and Contractors

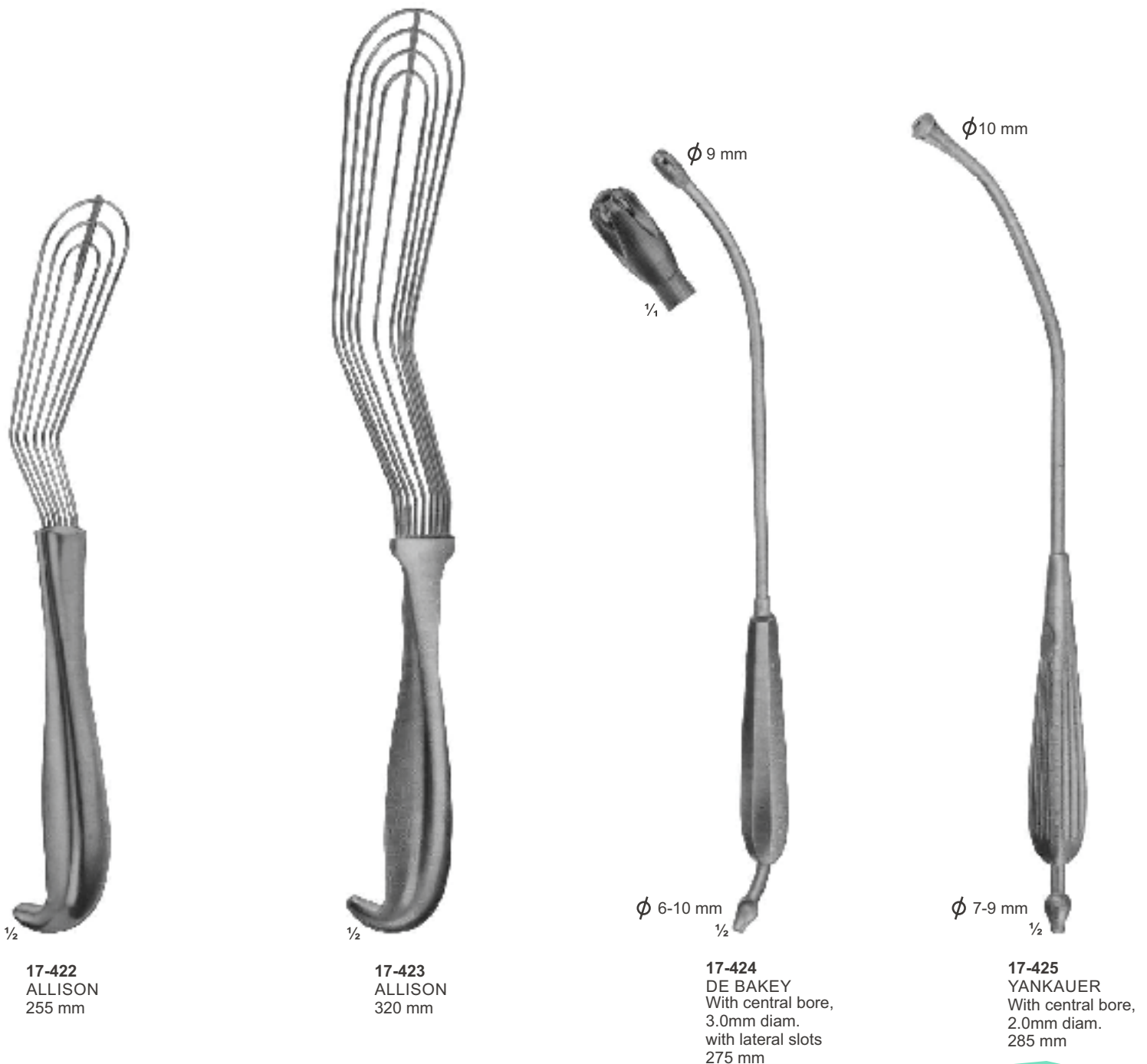

Punches

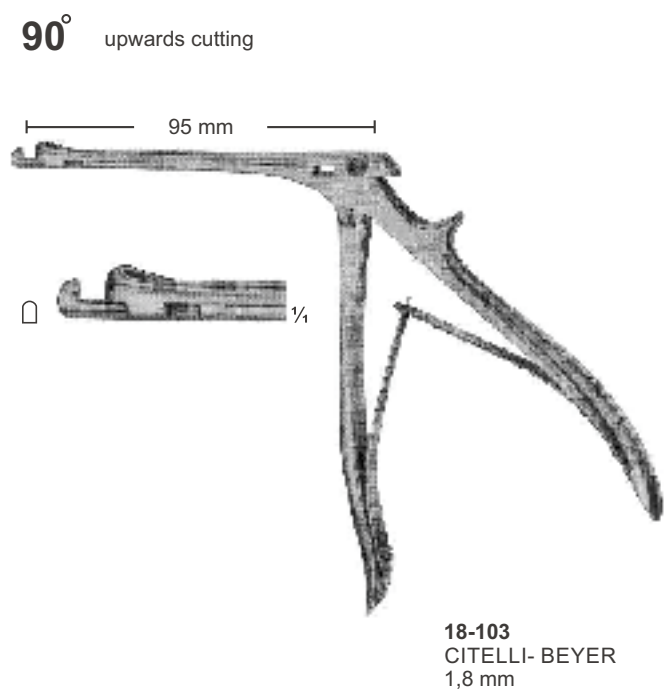
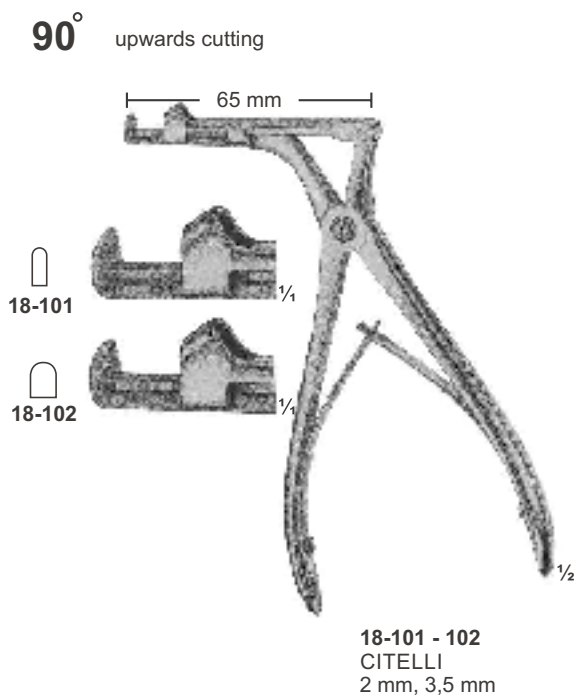
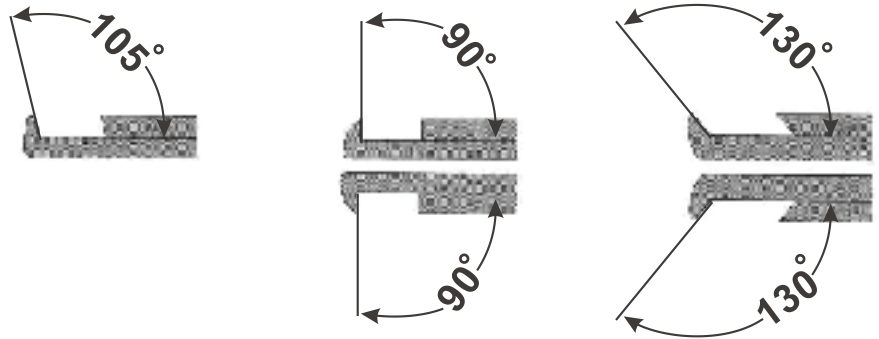

Punches

90° upwards cutting

85 mm

18-104
4 mm



1/4

18-105
5 mm



1/4

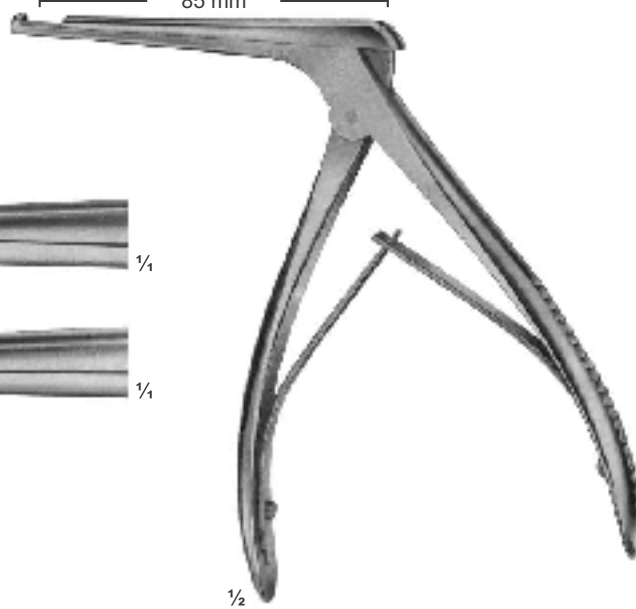

1/2

18-104 - 105
KERRISON

90° upwards cutting

140 mm

18-106
3,3 mm



1/4

18-107
4,0 mm



1/4

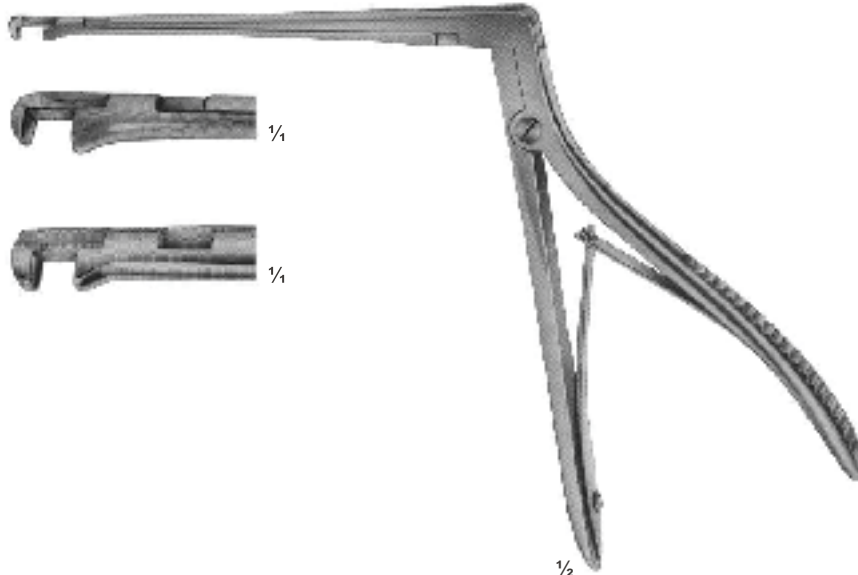

1/2

18-106 - 107
HAJEK-KOFLER

Punches

130° upwards cutting

18-108
1 mm □

18-109
2 mm □

18-110
3 mm ◐

18-111
4 mm ◐

18-112
5 mm ◐

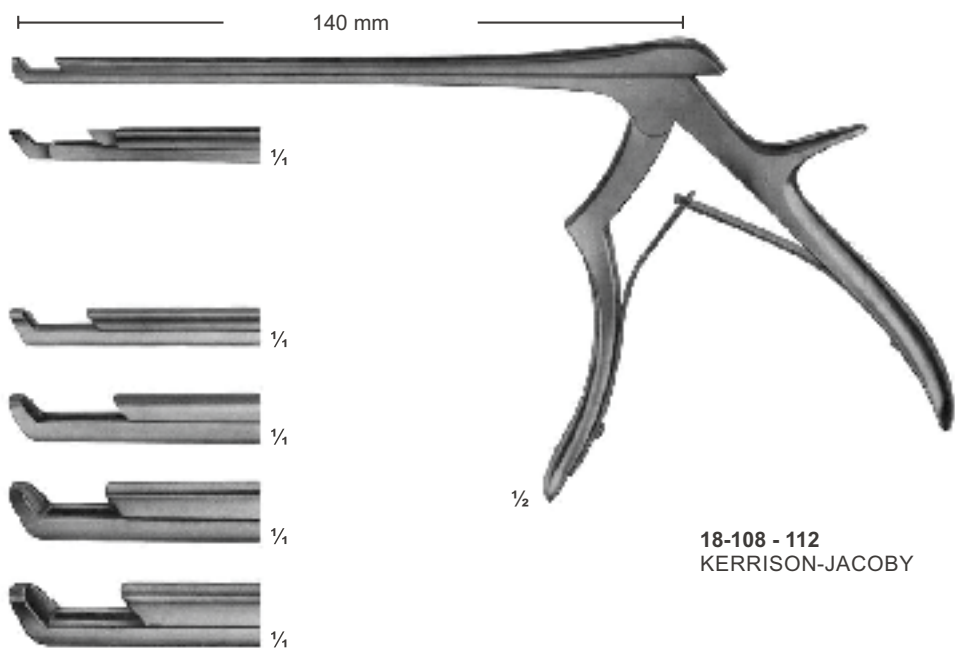

18-108 - 112
KERRISON-JACOBY

90° upwards cutting

18-113
1 mm □

18-114
2 mm □

FERRIS-SMITH-KERRISON

18-115
3 mm ◐

18-116
4 mm ◐

18-117
5 mm ◐

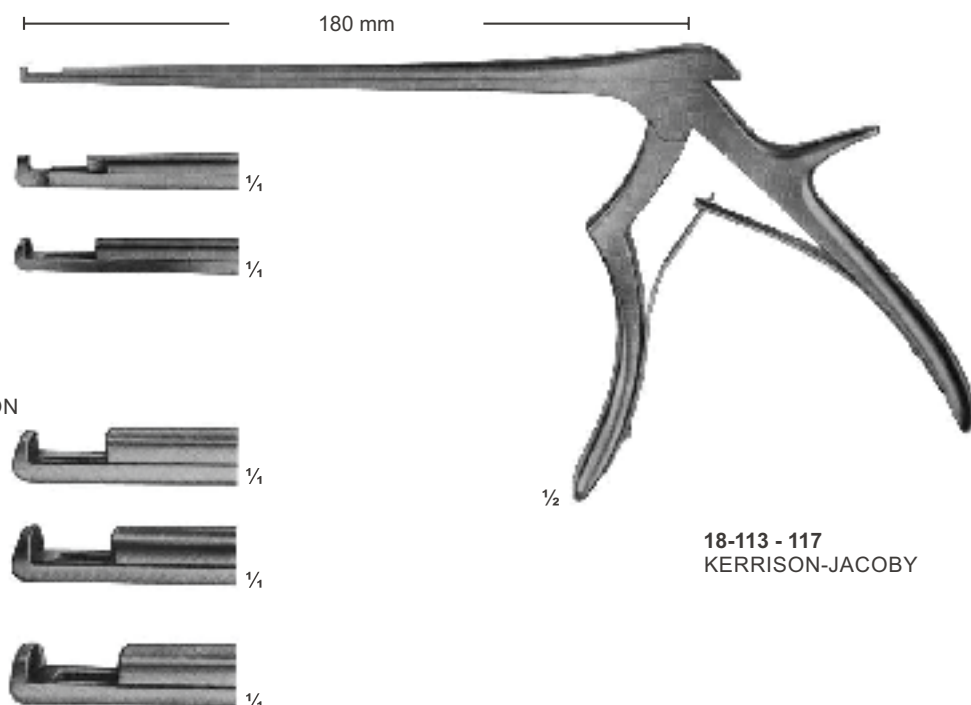

18-113 - 117
KERRISON-JACOBY

Rongeurs

Angled positions for rongeurs

- 18-118**
3,0 mm
- 18-119**
3,6 mm
- 18-120**
4,2 mm
- 18-121**
4,8 mm
- 18-122**
5,8 mm

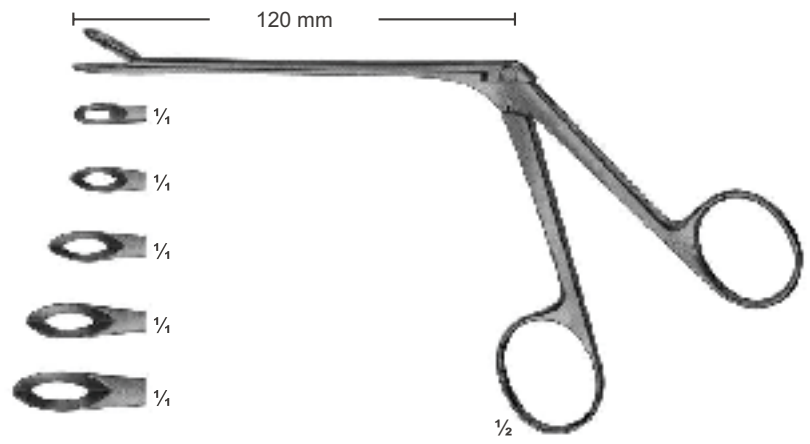

18-118 - 122
WEIL-BLAKESLEY

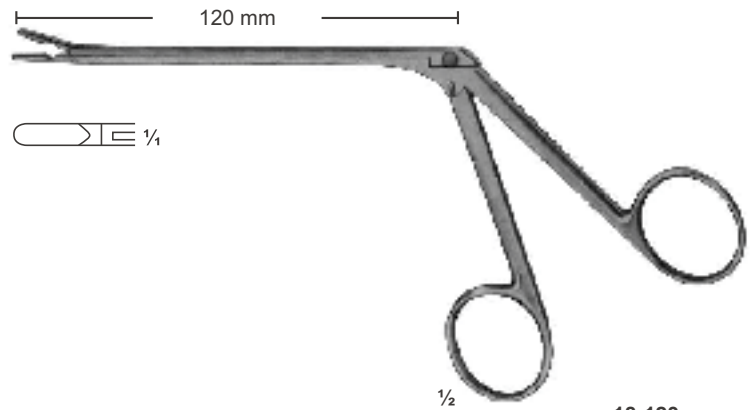

18-123
TAKAHASHI
3 mm

130°

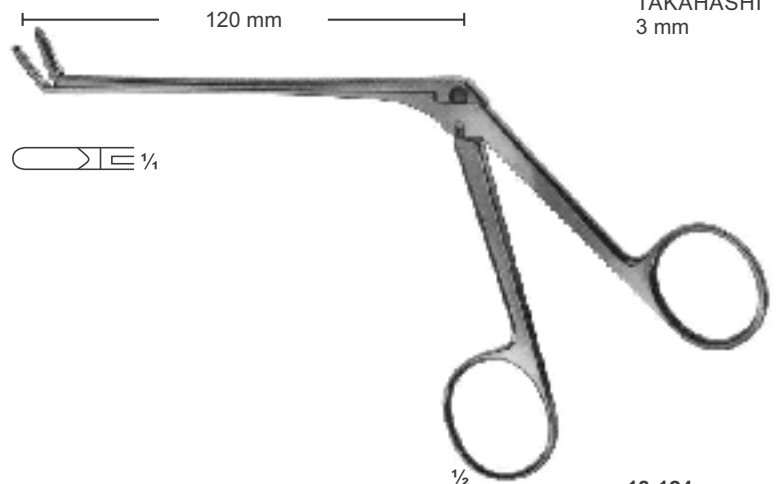

18-124
TAKAHASHI
3 mm

Rongeurs

130 mm

18-125
2 X 10 mm

18-126
3 X 10 mm

18-127
4 X 10 mm

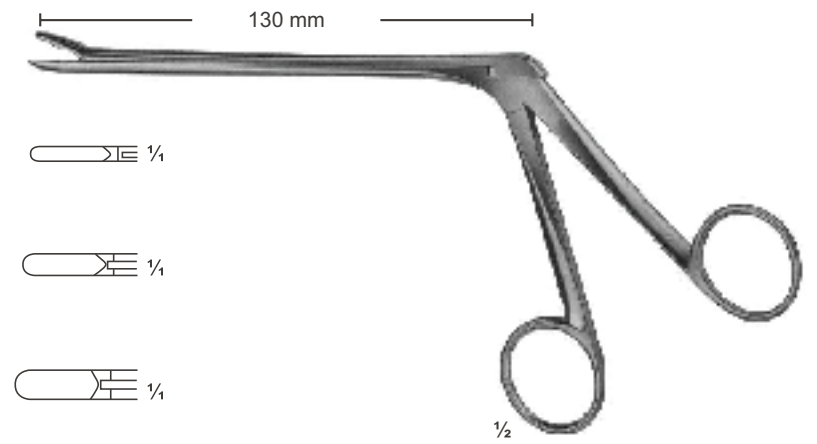

1/2

18-125 - 127
LOVE-GRUENWALD

155 mm

18-128
2 mm

18-129
3 mm

18-130
4 mm

18-131
5 mm

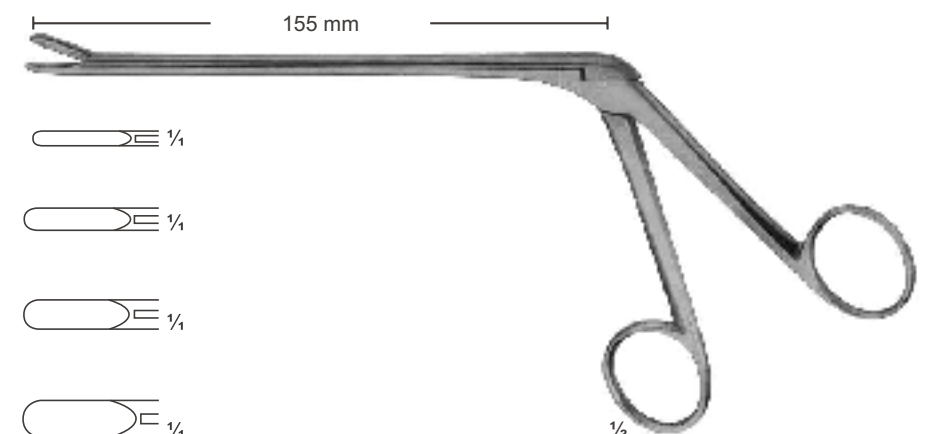

1/2

18-128 - 131
CASPAR

155 mm

18-132
2 mm

18-133
3 mm

18-134
4 mm

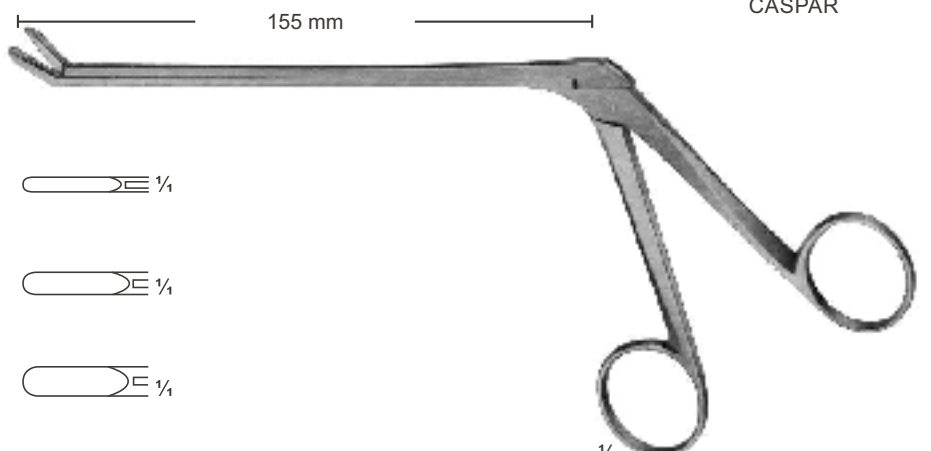

1/2

18-132 - 134
CASPAR

Rongeurs

18-135
2 mm

18-136
3 mm

18-137
4 mm

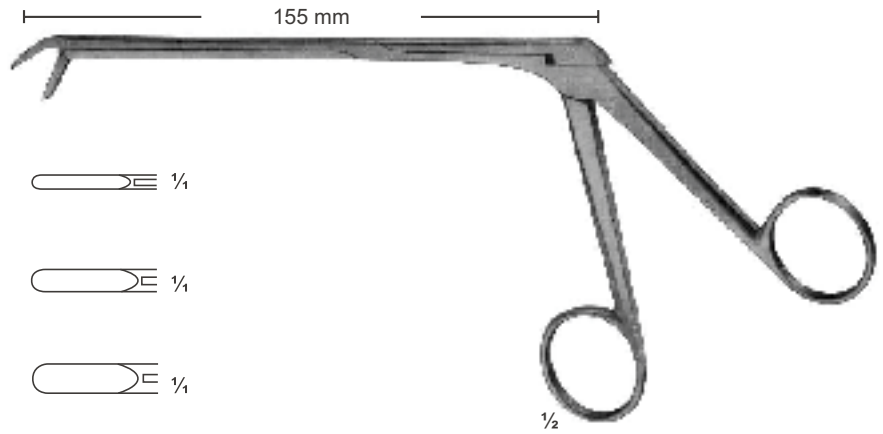

18-135 - 137
CASPAR

| Length of shaft 140 mm | Length of shaft 160 mm | Length of shaft 185 mm | size of jaws |
|---------------------------|---------------------------|---------------------------|--------------|
| 18-138 | 18-143 | 18-148 | 2 X12 mm |
| 18-139 | 18-144 | 18-149 | 3 X12 mm |
| 18-140 | 18-145 | 18-150 | 4 X14 mm |
| 18-141 | 18-146 | 18-151 | 5 X14 mm |
| 18-142 | 18-147 | 18-152 | 6 X16 mm |

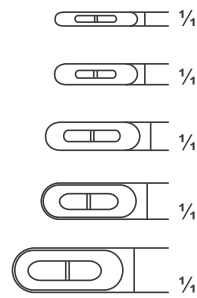

18-138 - 152
CASPAR

| Length of shaft 140 mm | Length of shaft 160 mm | Length of shaft 185 mm | size of jaws |
|---------------------------|---------------------------|---------------------------|--------------|
| 18-153 | 18-156 | 18-159 | 3 X12 mm |
| 18-154 | 18-157 | 18-160 | 4 X14 mm |
| 18-155 | 18-158 | 18-161 | 5 X14 mm |

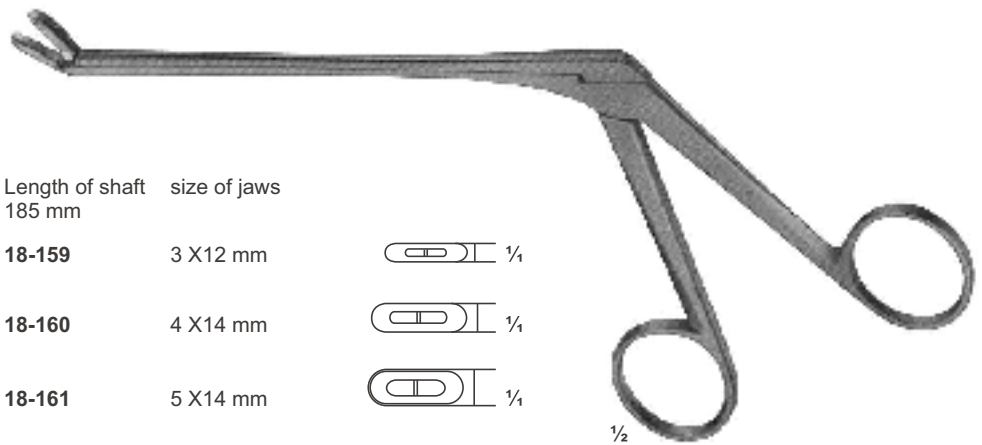
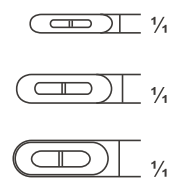

18-153 - 161
CASPAR

Rongeurs

| Length of shaft 140 mm | Length of shaft 160 mm | Length of shaft 185 mm | size of jaws |
|---------------------------|---------------------------|---------------------------|--------------|
| 18-162 | 18-164 | 185-166 | 3 X12 mm |
| 18-163 | 18-165 | 18-167 | 4 X14 mm |

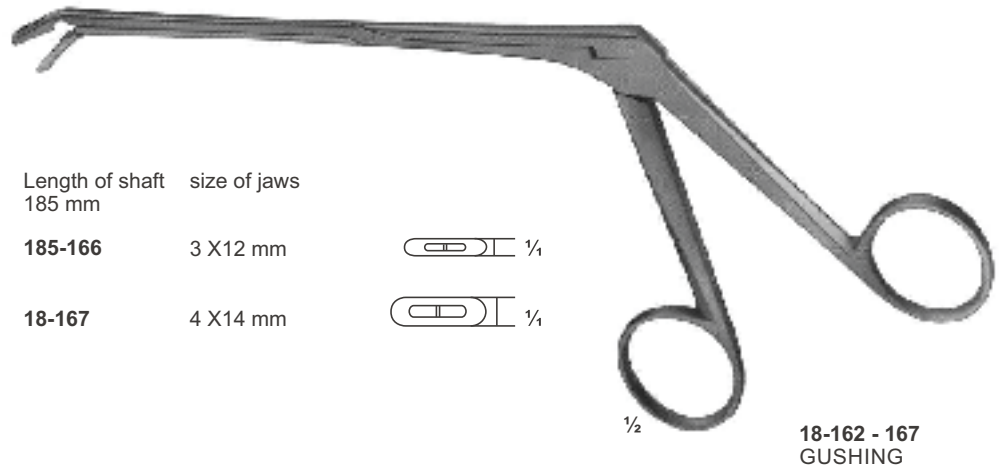

18-168
2 X 10 mm
GUSHING



18-169
3 X 10 mm
LOVE-GRUENWALD

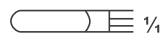

18-170
4 X 10 mm
SPURLING

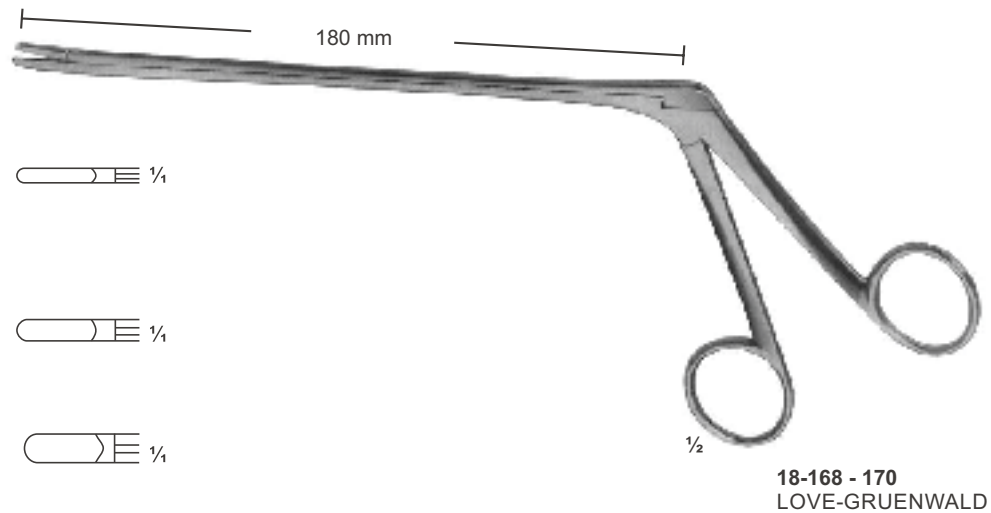
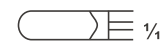

18-171
3 X 10 mm
LOVE-GRUENWALD



18-172
4 X 10 mm
SPURLING

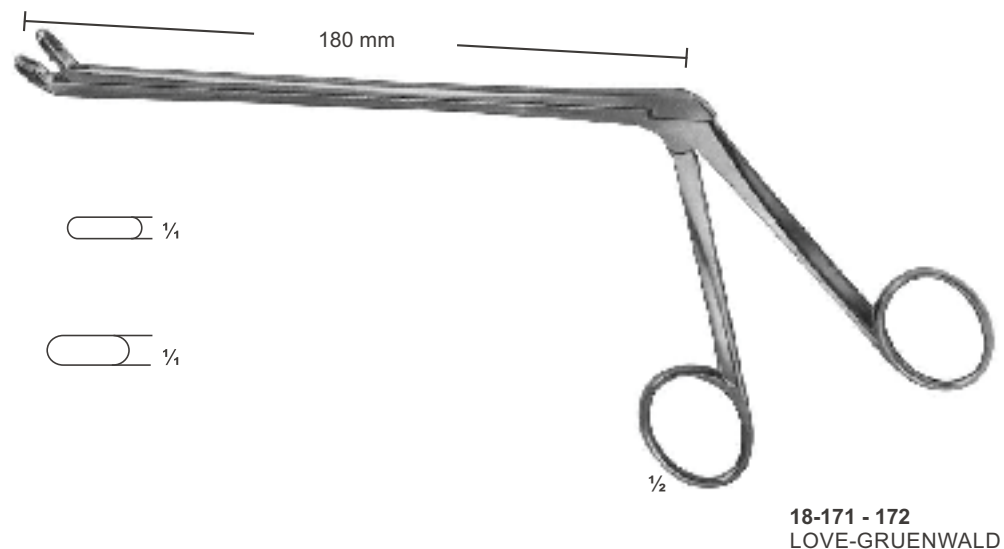

Rongeurs

18-173
3 X 10 mm
LOVE-GRUENWALD



18-174
4 X 10 mm
SPURLING

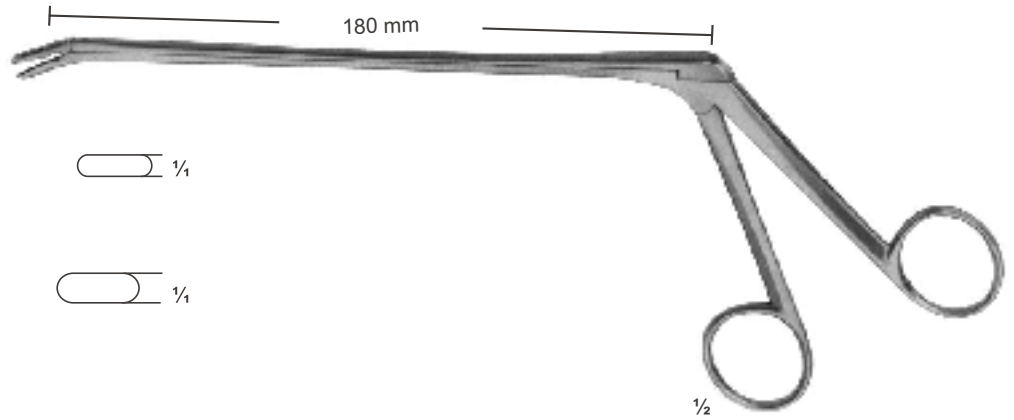
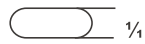

18-173 - 174
LOVE-GRUENWALD

18-175
7 mm

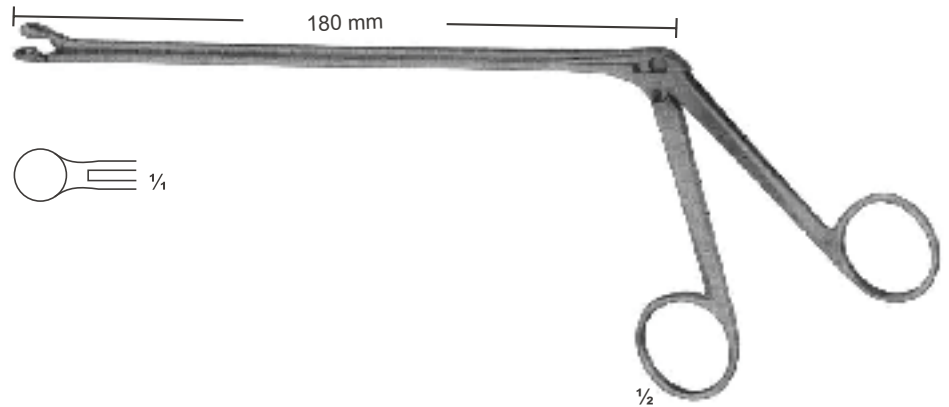
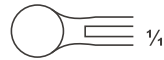

18-175
OLDBERG

18-176
YASARGIL
2,2 mm



18-177
YASARGIL
3,5 mm

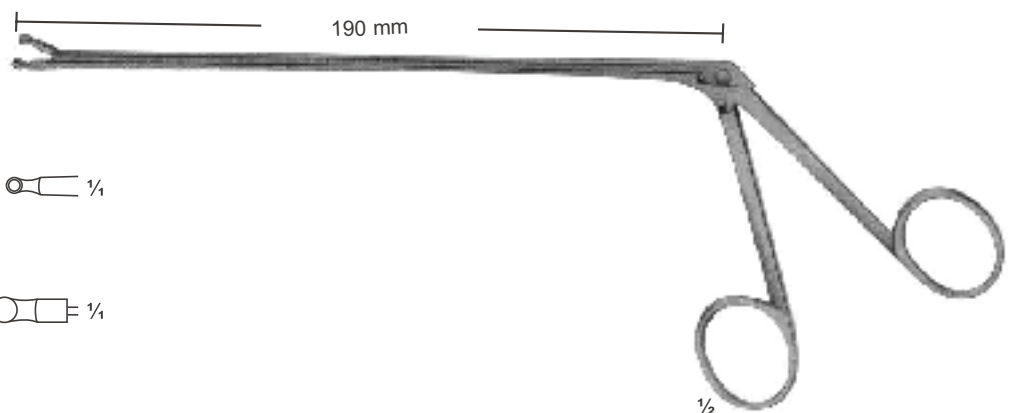

18-176 - 177

Rongeurs

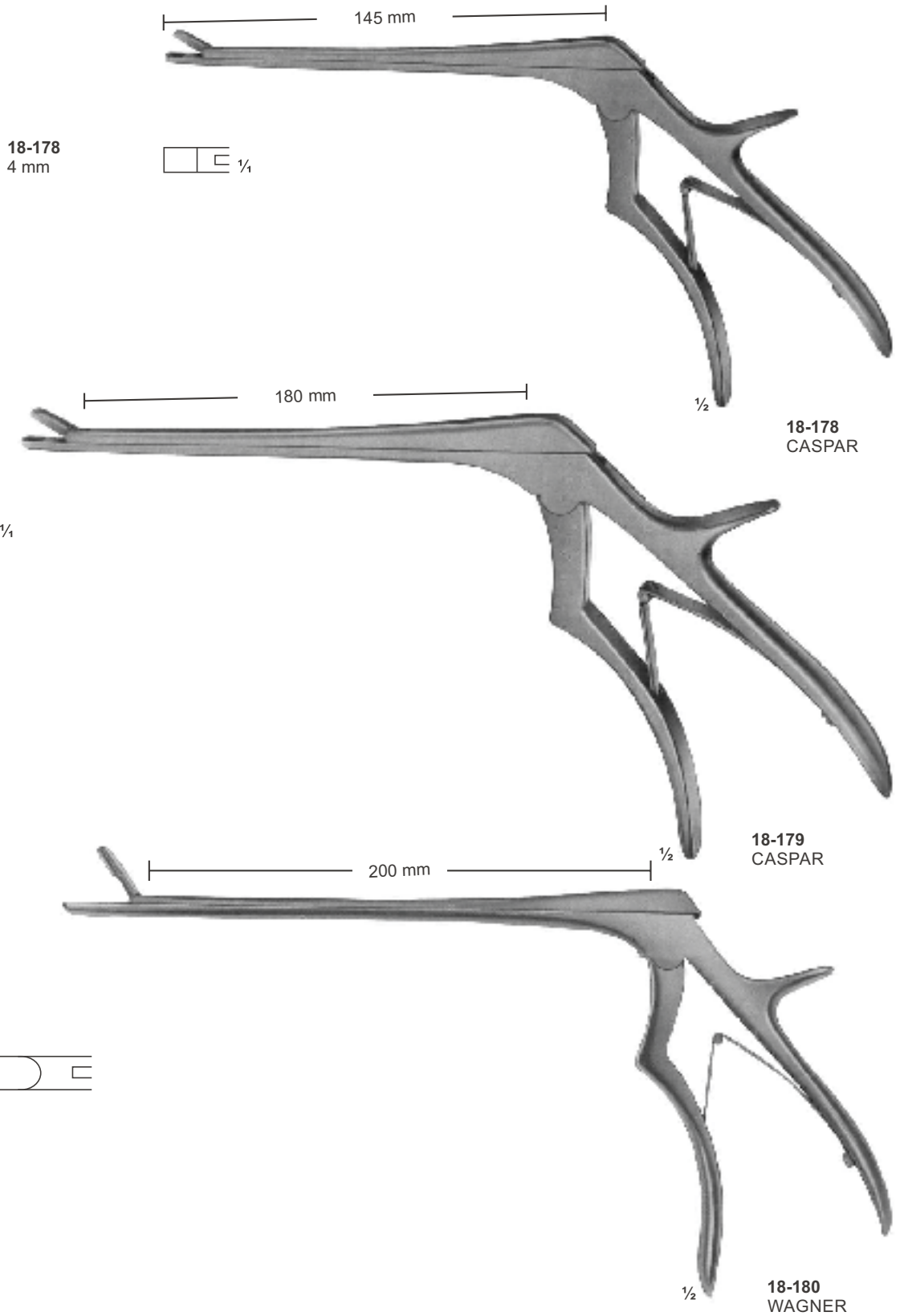

Amputation

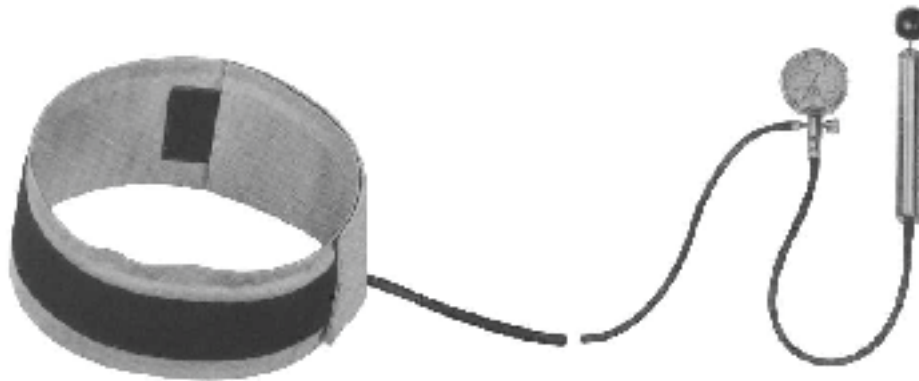

19-101
Comprimeter. Compression apparatus for producing exsanguination in the extremities. Manometer registers up to 600 mm Hg. Complete, consisting of :
19-101 2 Pump with manometer
19-102 3 Cuff for the leg
19-103 14 Cuff for the upper arm

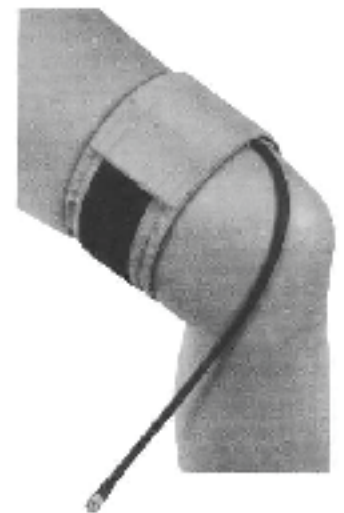

19-104 3 Cuff for the leg
19-105 4 Cuff for the lower arm
19-106 5 Cuff for children
19-107 14 Cuff for the upper arm



19-108
ESMARCH
Staubinde
Compression bandage
5 m lang/long
6 cm breit/wide



19-109
ESMARCH
Stauschlauch
Compression tube
1 m lang/long

Amputation and Resection Knives



19-110
Length of blades
Phalangeal knife
105 mm



19-111
Length of blades
Interosseous knife
110 mm



19-112
Length of blades
Periosteum knife
with raspatory
65 mm



19-113 - 114
LANGENBECK
Length of blades
Resection knives
55 mm



19-113

19-114

Amputation Retractors

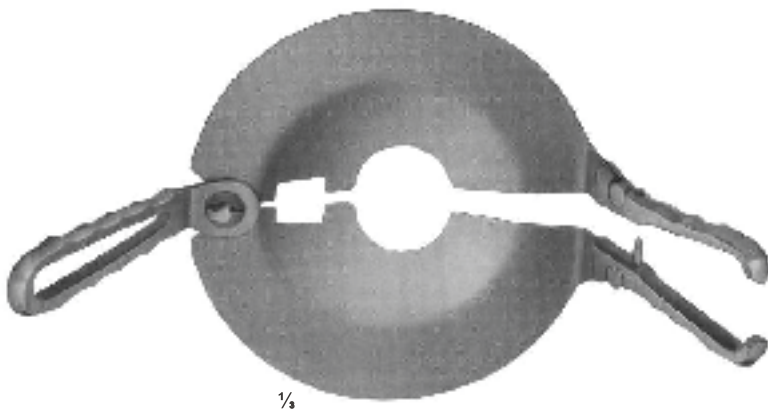

19-115
PERCY
removeable handles

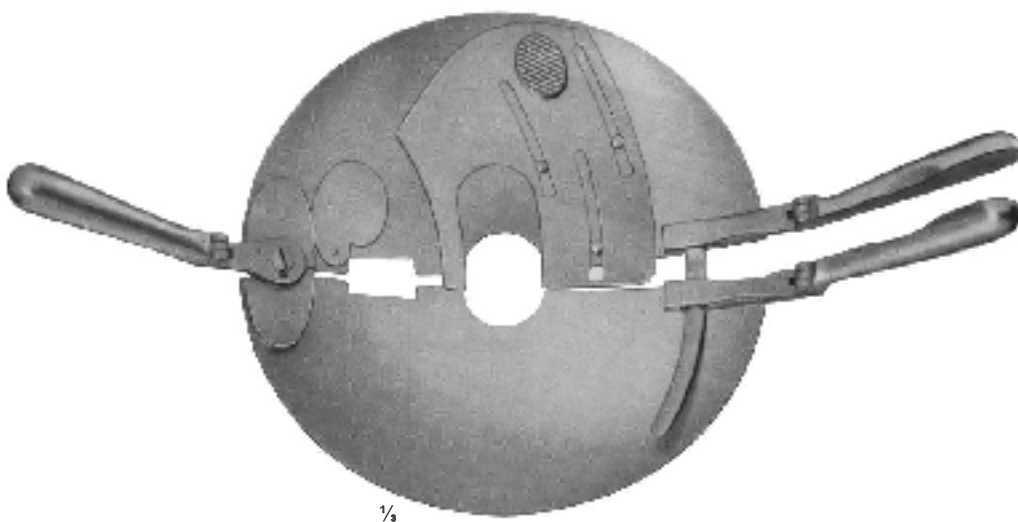

19-116
PERCY
reversible handles

Amputation Saws



1/4

19-117
CHARRIEER
 Length of blade
 215 mm
 complete with one saw
 blade each
 350 mm
 Spare saw blades, carbon steel
19-118 12 mm
19-119 20 mm



19-120 1/4

RUST
 Length of blade
 235 mm
 complete with one saw
 blade each
 390 mm
19-121 Bow only
 Spare saw blades, carbon steel
19-122 6 mm
19-123 8 mm
19-124 12 mm
19-125

Amputation Saws

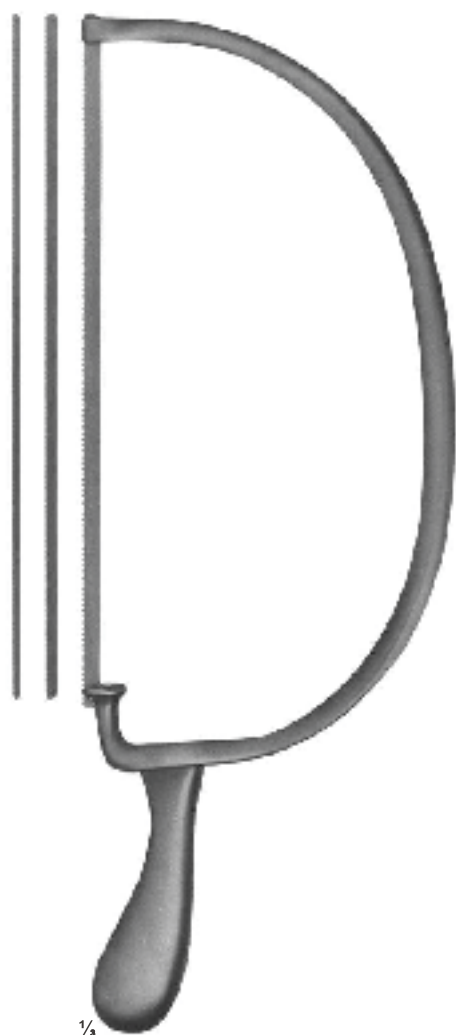

1/3

19-126
BIER
Length of blade
270 mm
complete with one saw
blade each
420 mm
Spare saw blades, carbon steel
19-127 4 mm
19-128 6 mm
19-129 8 mm

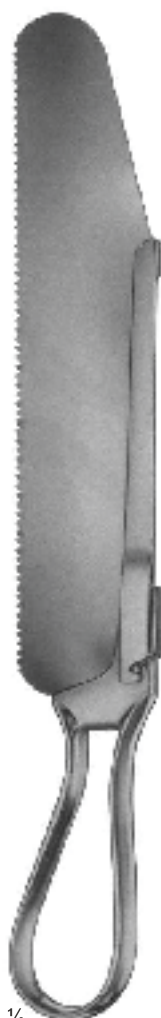

1/3

19-130
CHARRIERE
Length of blade
180 mm
Spare saw blades,
carbon steel
270 mm

19-131
CHARRIERE
Length of blade
240 mm
Spare saw blades,
carbon steel
340 mm



1/3

19-132
SATTERLEE
Length of blade
200 mm
Spare saw blades,
carbon steel
290 mm



1/3

19-133
LANGENBACK
Length of blade
115 mm
Metacarpal saw
235 mm

Wire Saws and Conductor



OLIVECRONA
19-134 300 mm
19-135 400 mm
19-136 500 mm
19-137 700 mm

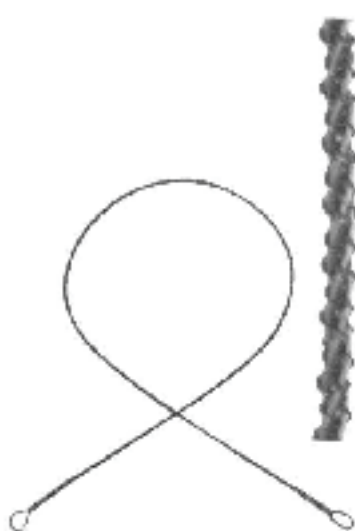

GIGLI
19-138 300 mm
19-139 400 mm
19-140 500 mm
 fine, 6 wires twisted
19-141
 coarses, 4 wires twisted



19-142
GIGLI
 Handle



19-143
LEBSCHE
 Conductor for
 wire saws, malleable
 250 mm

Elevators and Bone Levers

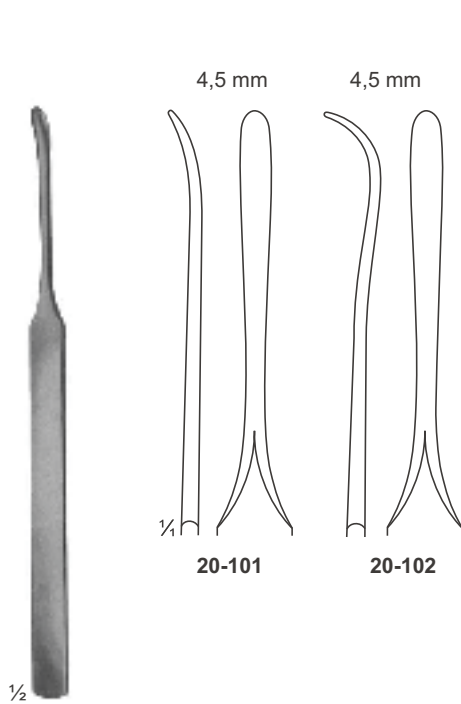

20-101 - 102
KONIG
155 mm

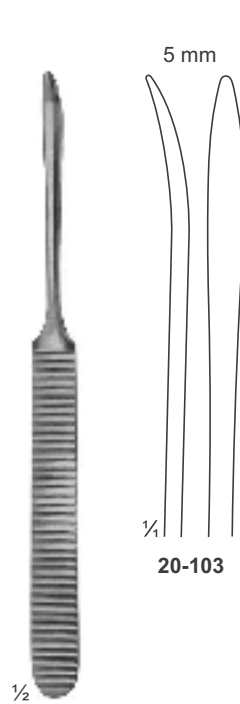

20-103
WILLIGER
165 mm

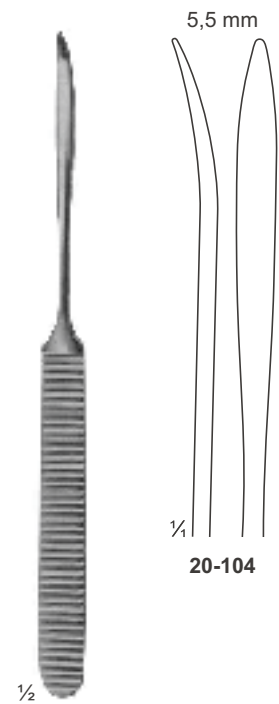

20-104
WILLIGER
170 mm

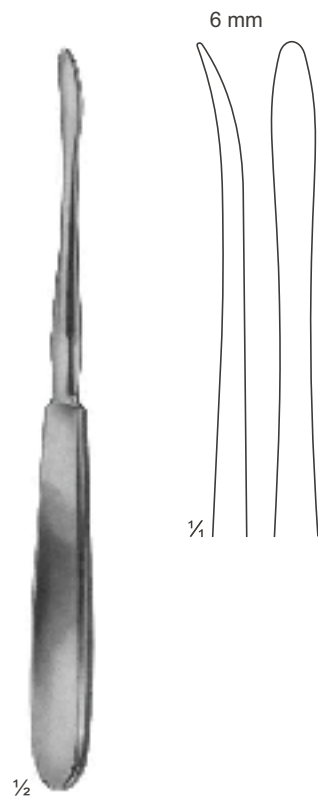

20-105
QUERVAIN
195 mm

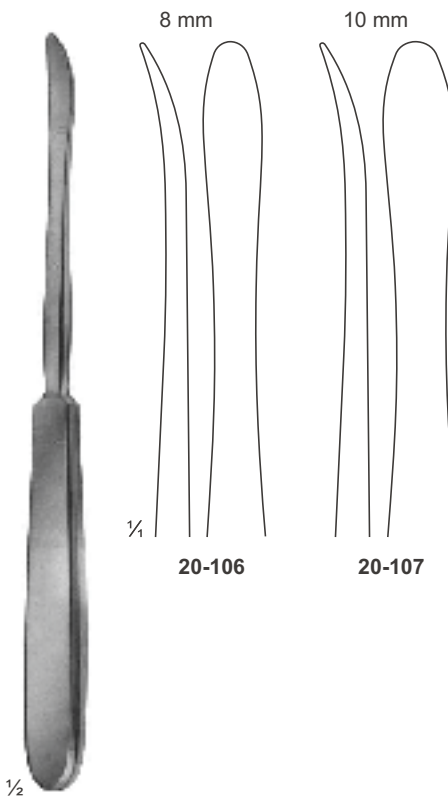

20-106 - 107
LANGENBACK
195 mm

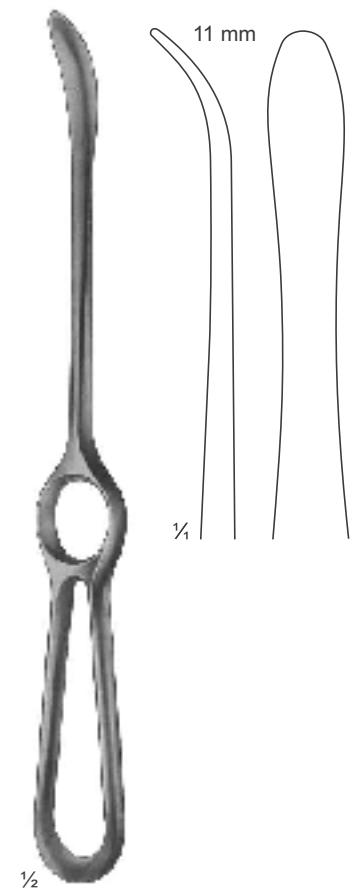

20-108
LANGENBACK
230 mm

Bone Levers

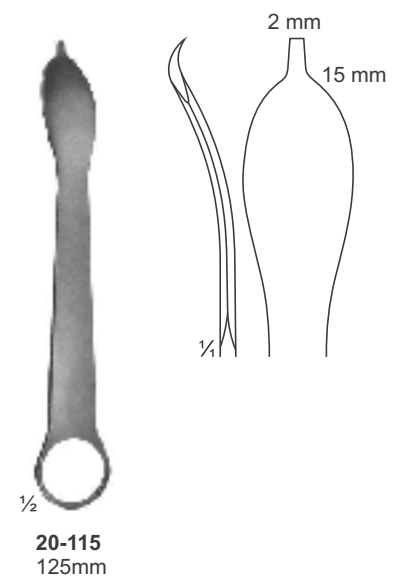
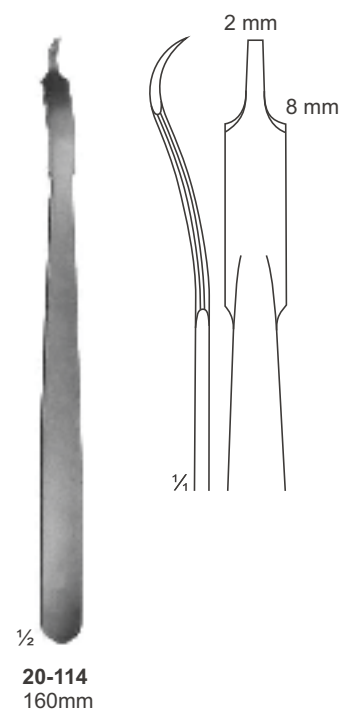
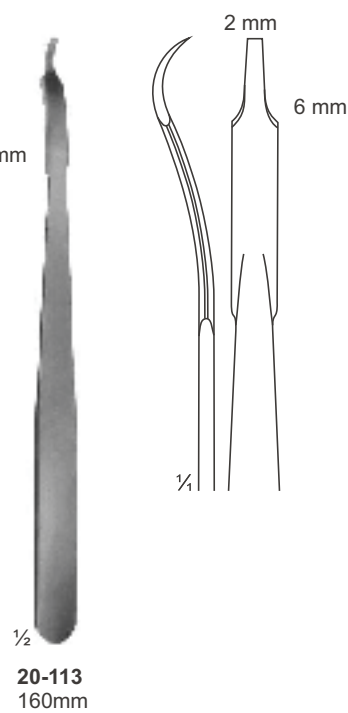
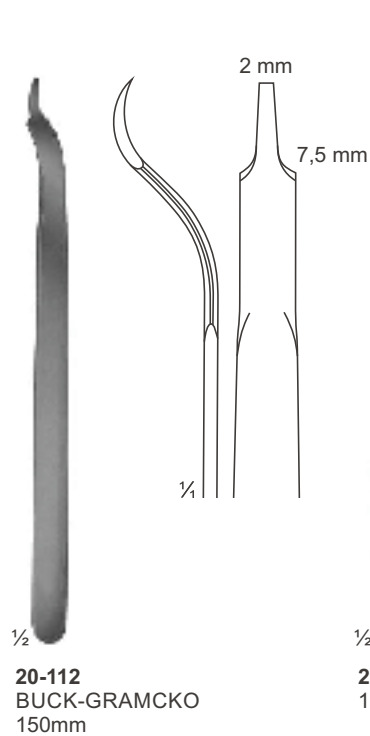
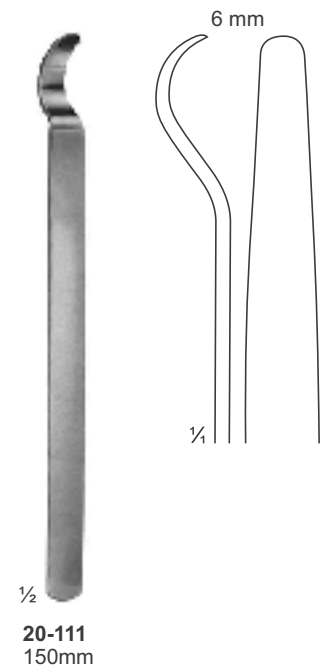
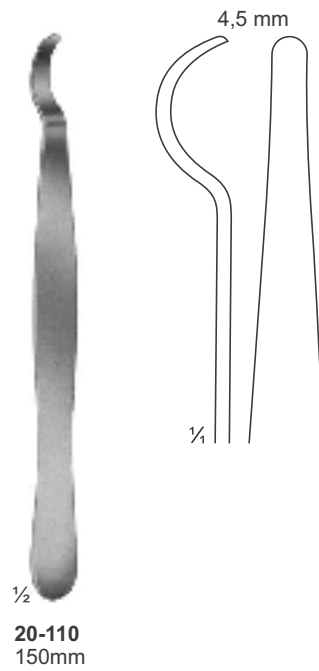
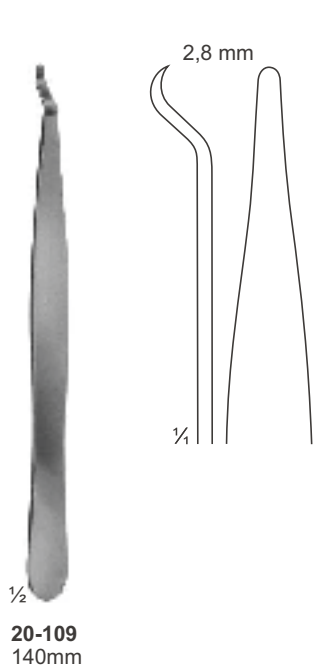

Bone Levers



20-116
LANE TRETOWAN
215mm

20-117
LANE
255mm

20-118
LANGE-HOHMANN
250mm

20-119 - 120
LANGE-HOHMANN
20-119 265mm
20-120 280mm

Bone Levers

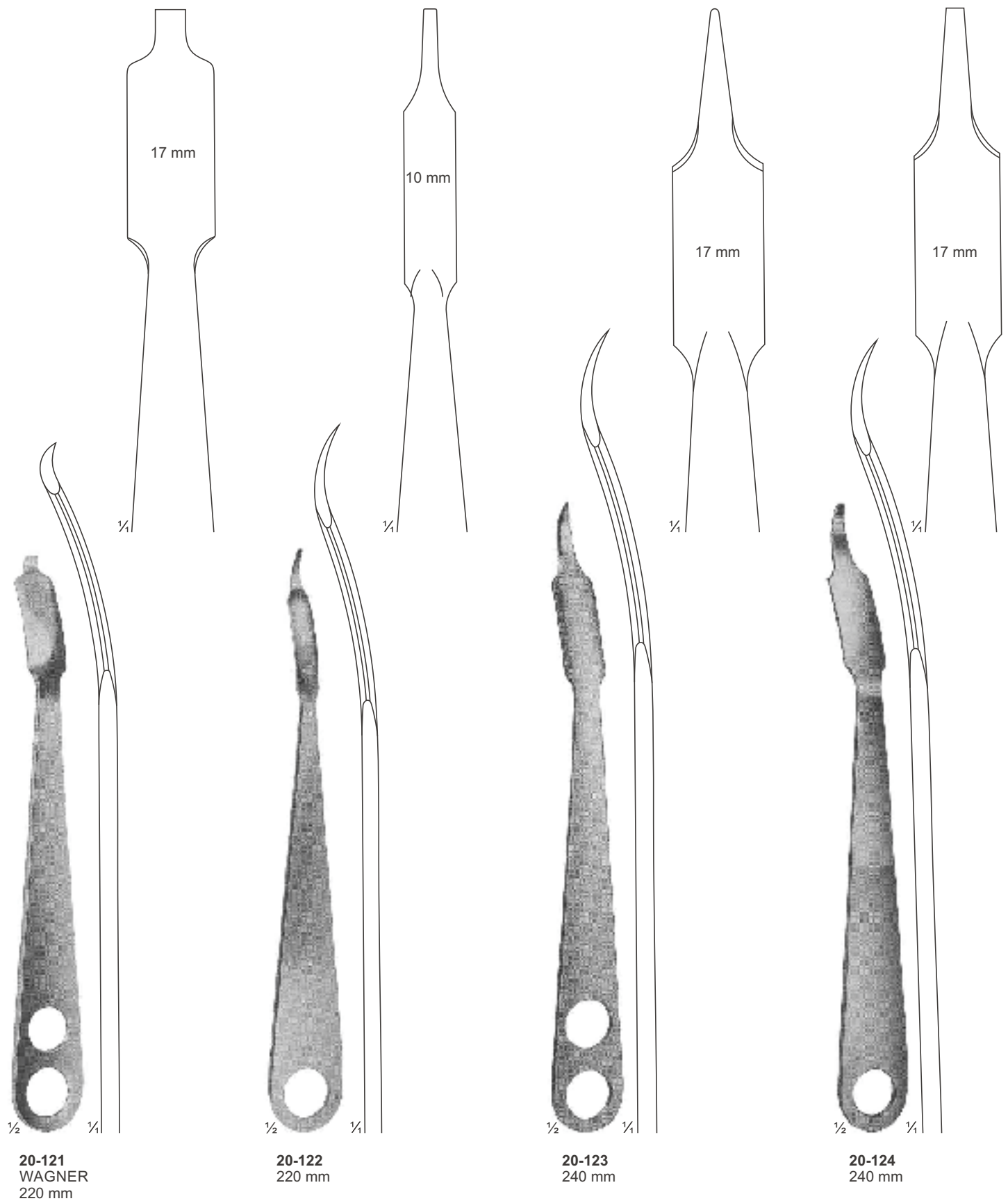

Bone Levers

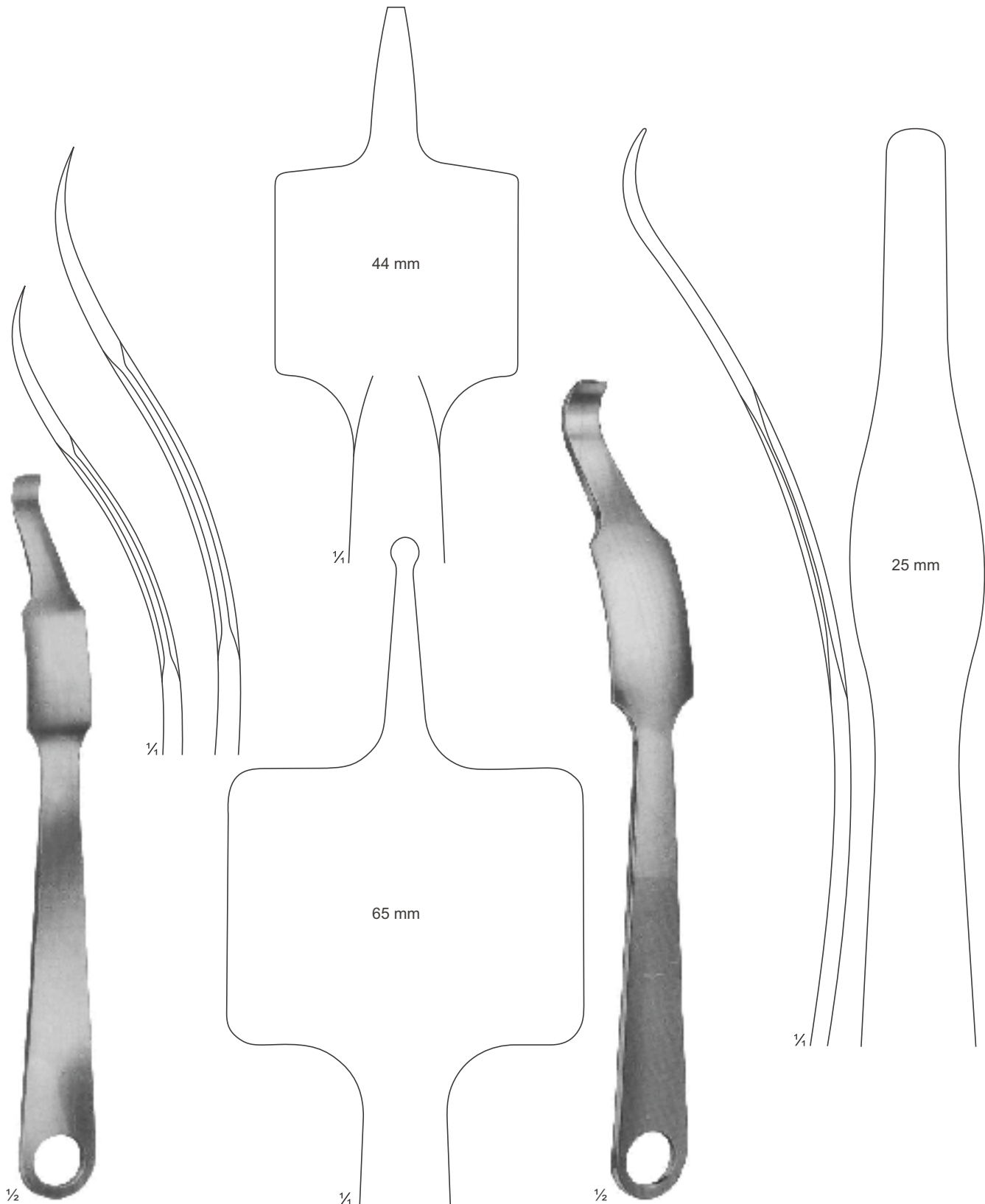

20-125 - 126
VERBRUGGE-MULLER
20-125 240 mm
20-126 255 mm

20-127
260 mm

Bone Levers

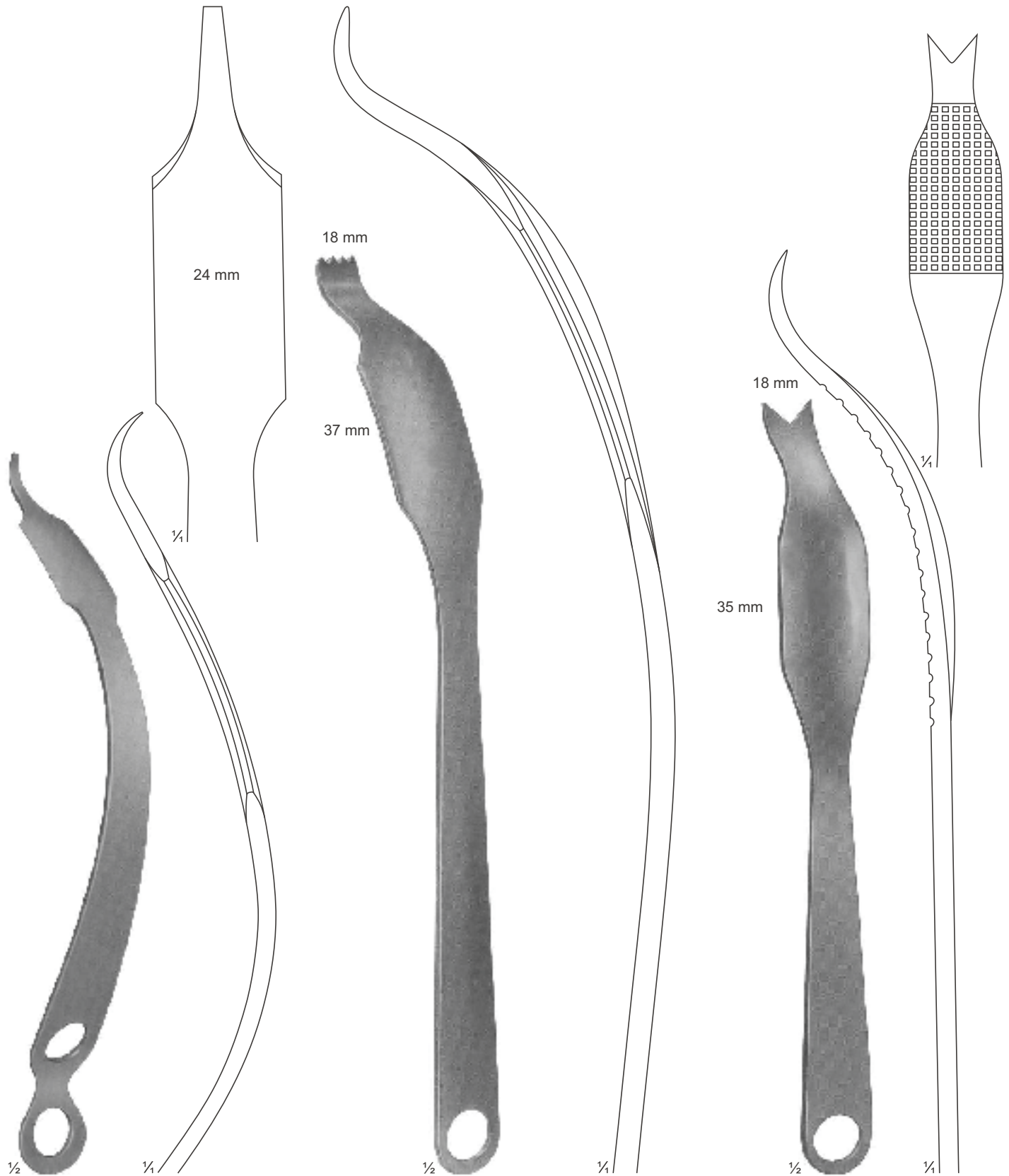

20-128
HOHMANN-ALDINGER
270 mm

20-129
SCHUMACHER mod. WAGNER
345 mm

20-130
SCHUMACHER
290 mm

Special Bone Levers

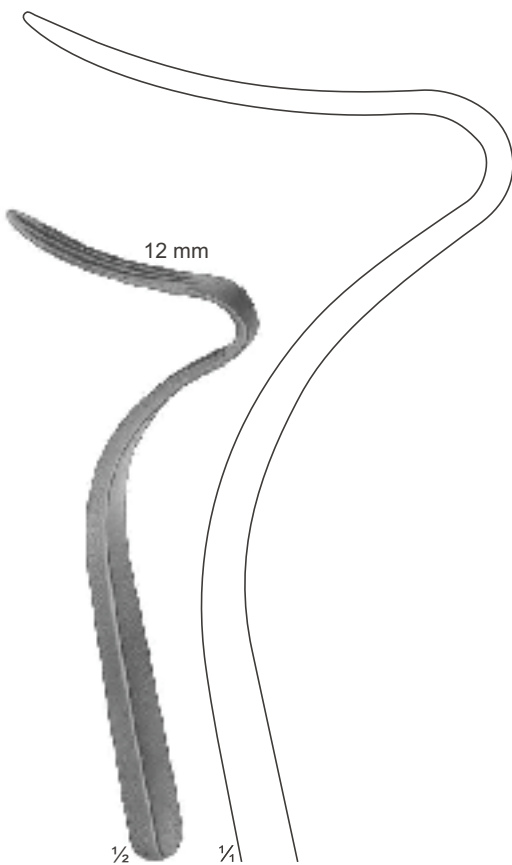

20-131
TAGER
Bone lever for
angle joint operations
175 mm

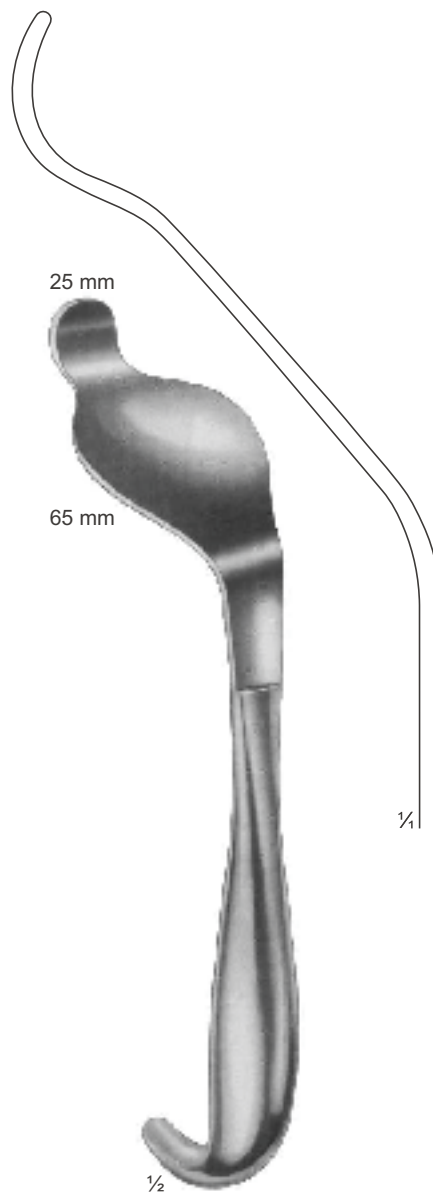

20-132
BENNETT
235 mm

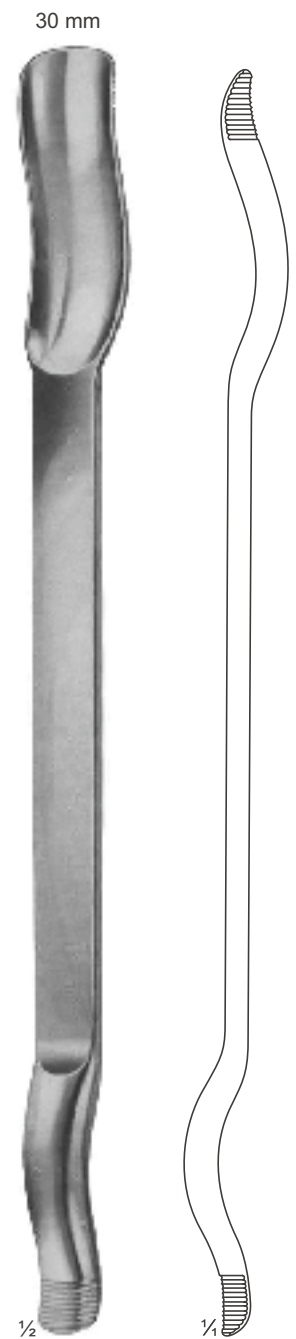

20-133
MURPHY-LANE
Luxation lever
340 mm

Raspatories

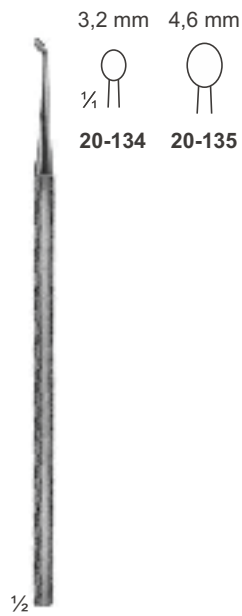

20-134 - 135
PARTSCH
150 mm

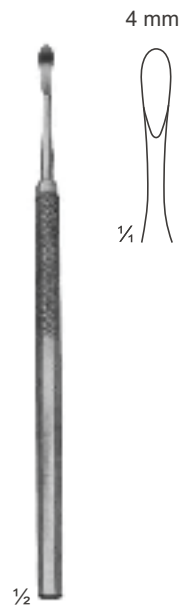

20-136
PARTSCH mod. LANGE
145 mm



20-137
MC KENTY
155 mm

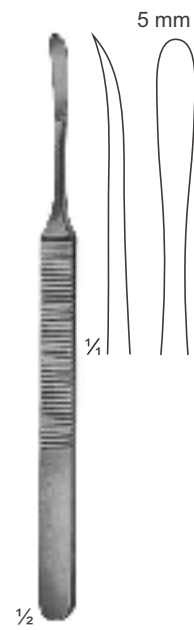

20-138
KONIG
155 mm

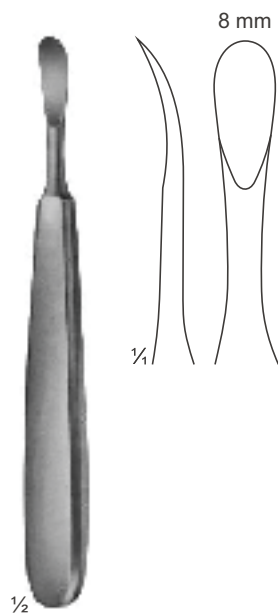

20-139
TRELAT
150 mm

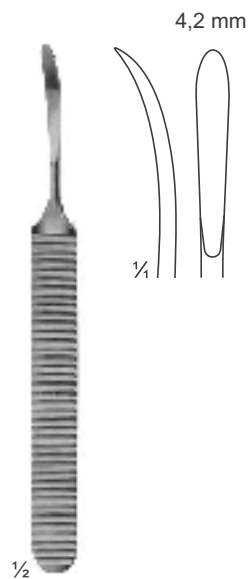

20-140
WILLIGER
140 mm

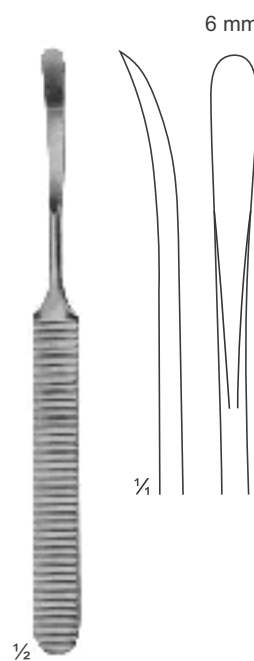

20-141
WILLIGER
160 mm

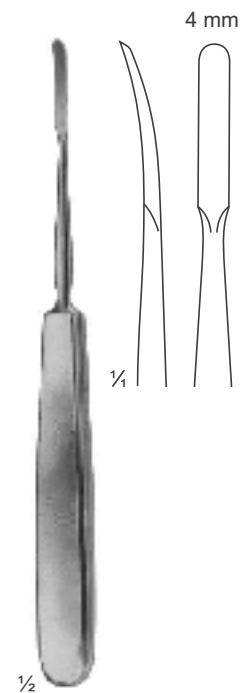

20-142
JOSEPH
170 mm

Raspatories

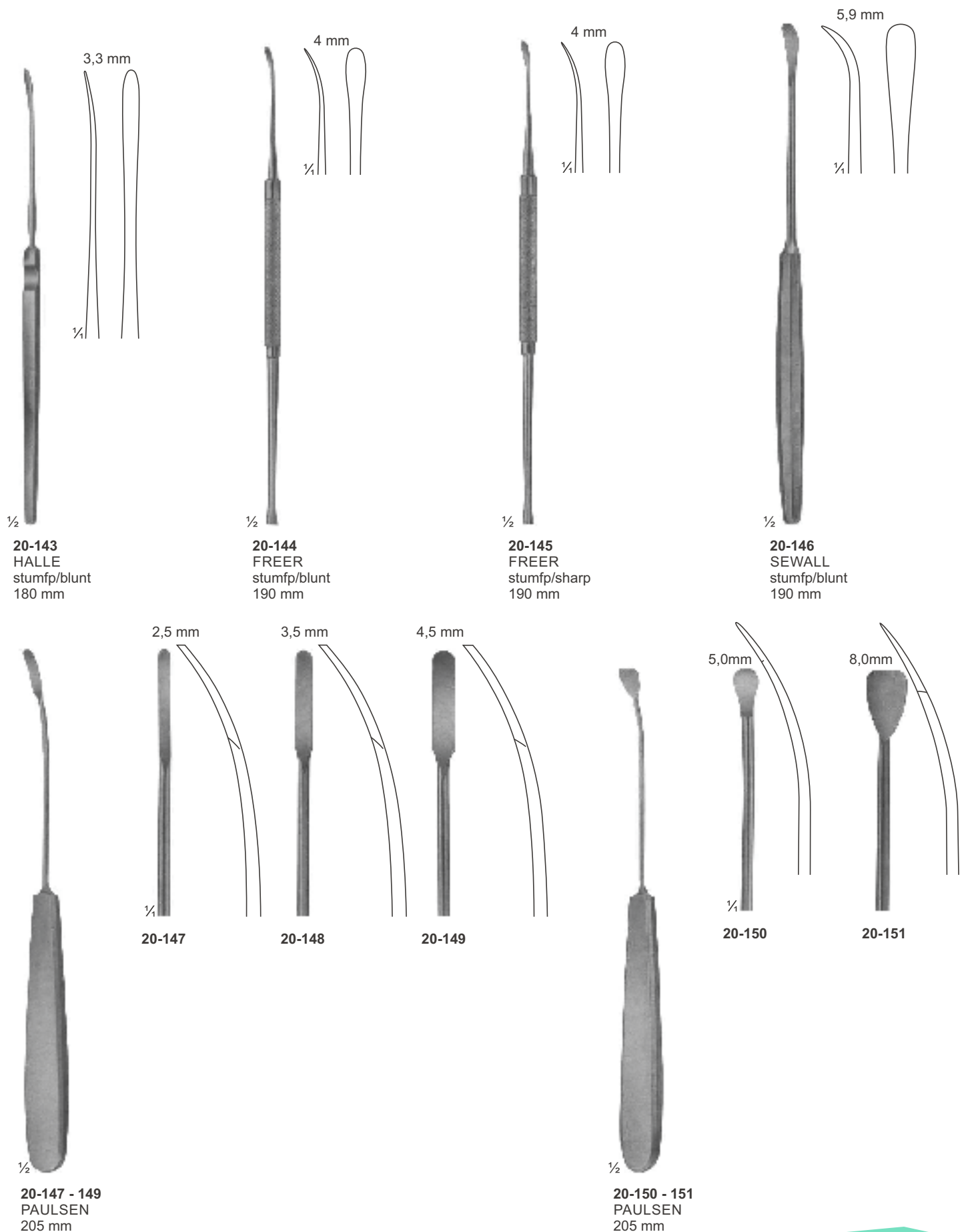

Raspatories

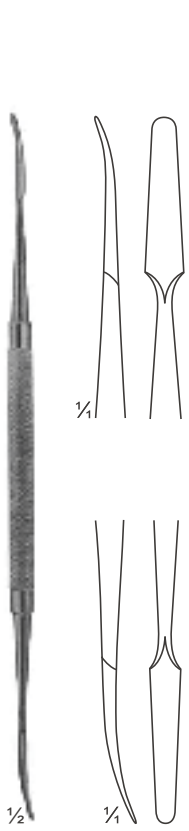

20-152
KILLIAN
sharp/blunt
185 mm

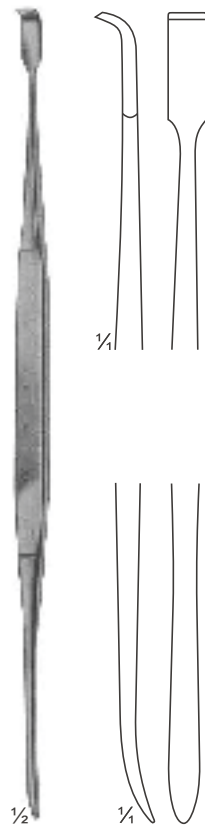

20-153
HOWARTH
sharp/blunt
215 mm

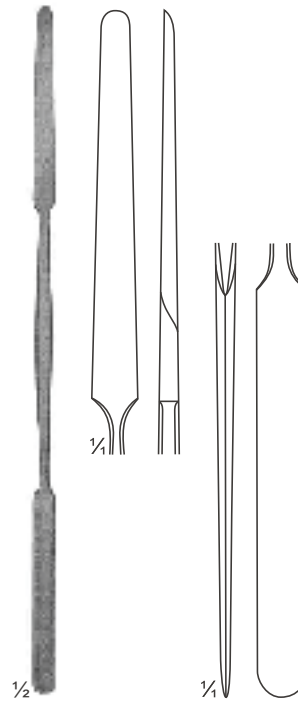

20-154
KILLIAN
sharp/blunt
185 mm

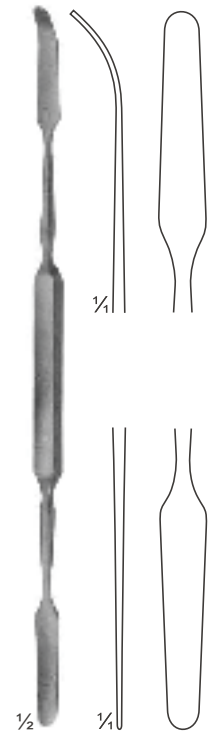

20-155
MAC DONALD
blunt/blunt
185 mm

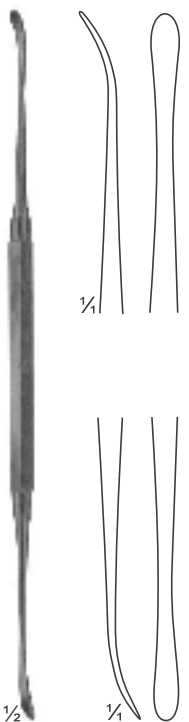

20-156
FREER
sharp/blunt
185 mm

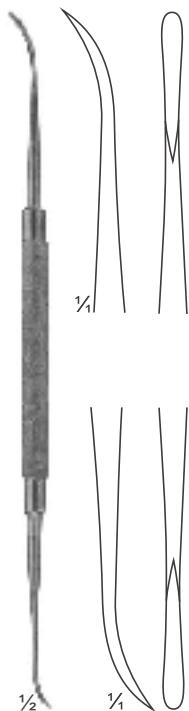

20-157
FREER-YASARGIL
sharp/sharp
185 mm

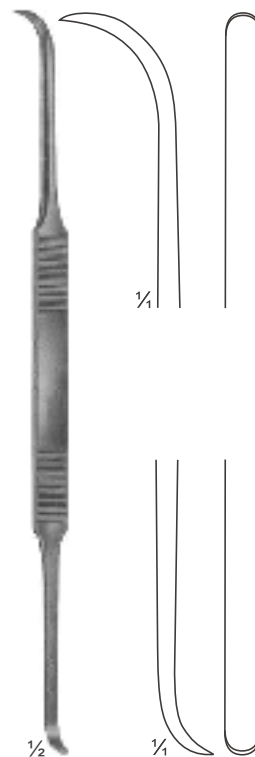

20-158
COTTLE
sharp/sharp
200 mm

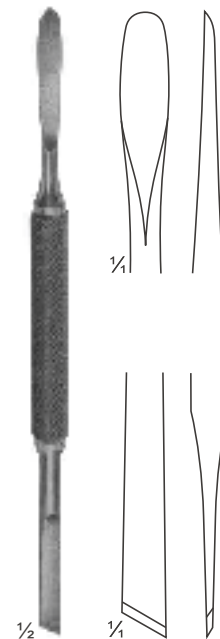

20-159
MEAD
sharp/sharp
165 mm

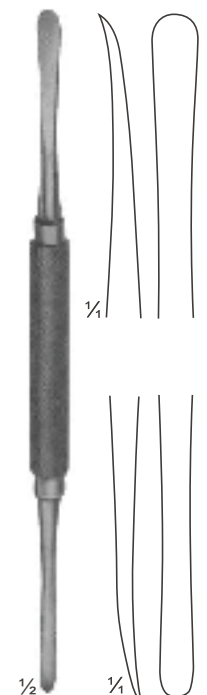

20-160
MOLT
sharp/sharp

Raspatories

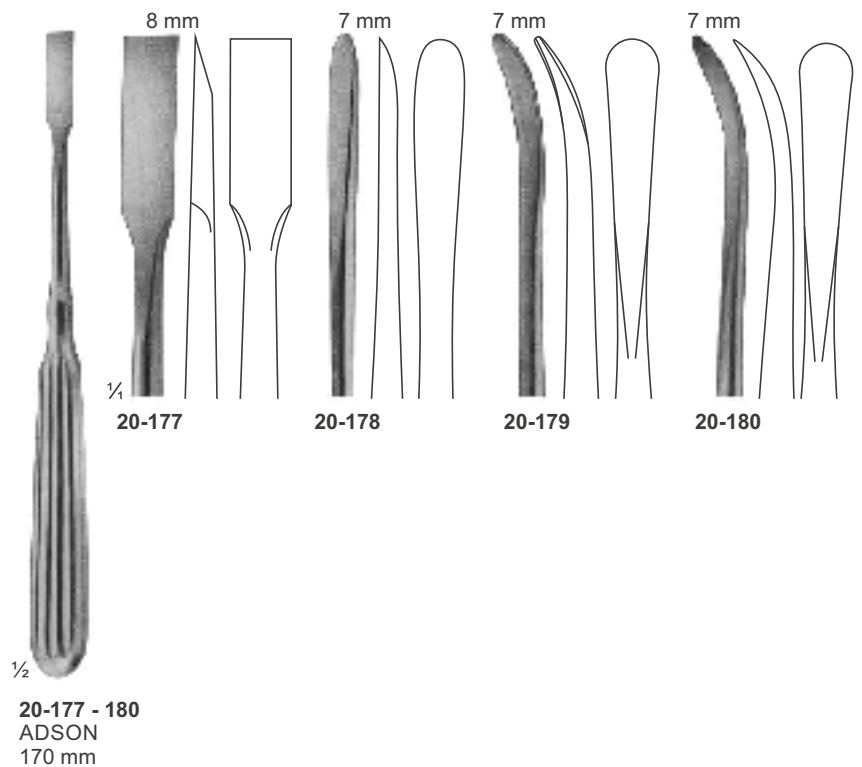
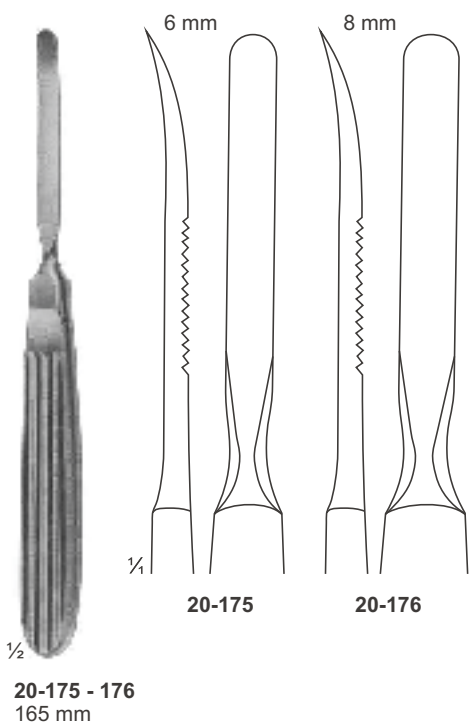
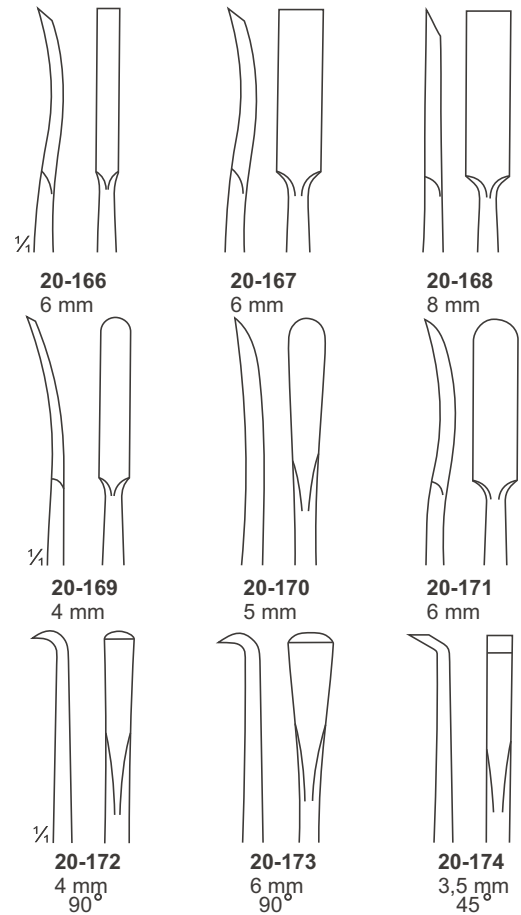
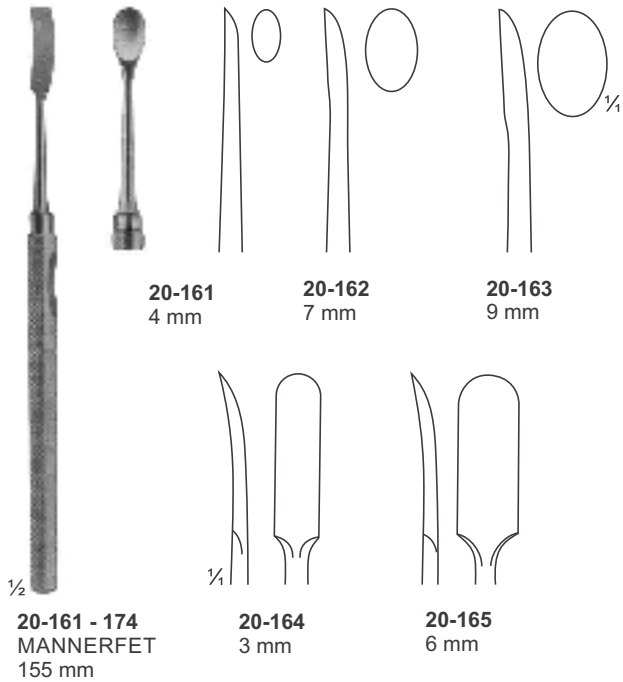

Raspatories

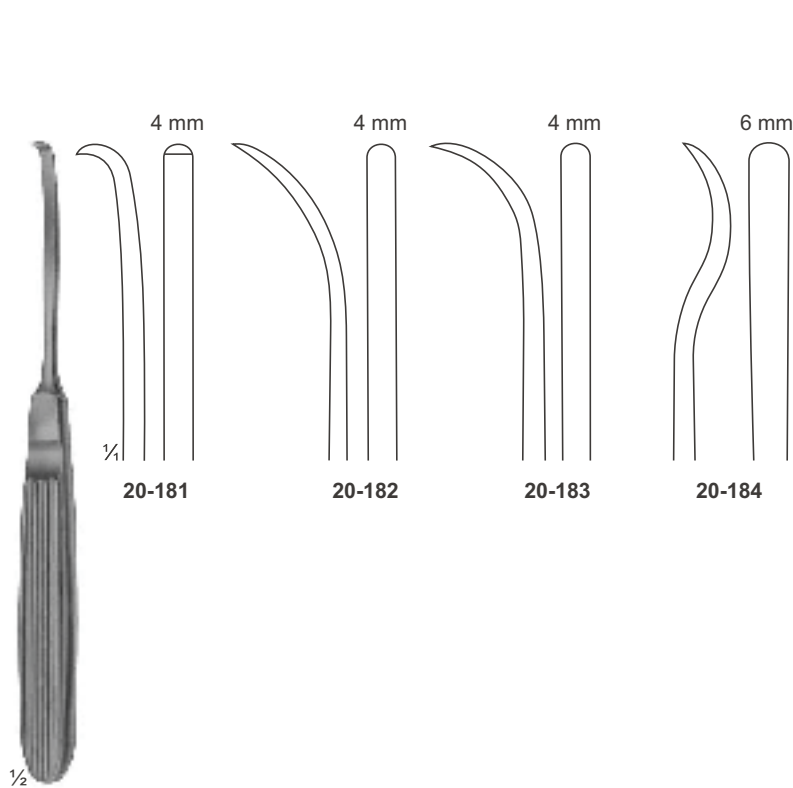

20-181 - 184
MUHLING
170 mm

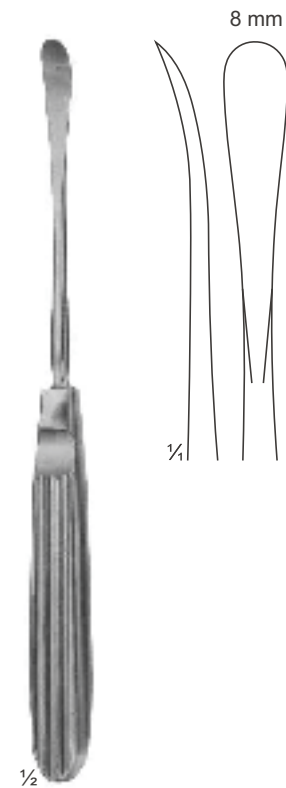

20-185
COTTLE
175 mm

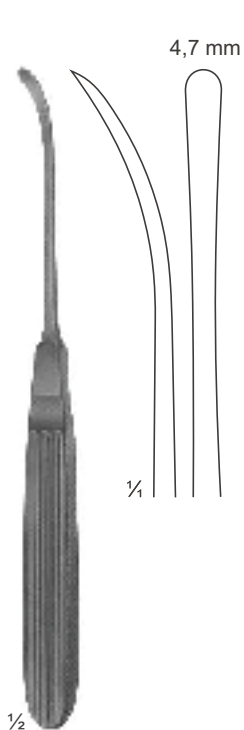

20-186
LANDOT
175 mm

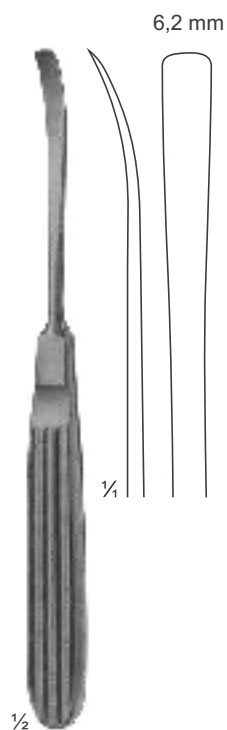

20-187
CASPER
180 mm

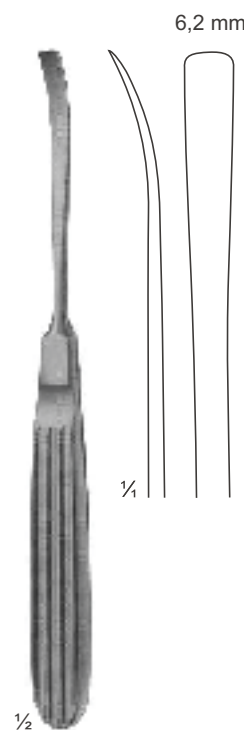

20-188
CASPER
180 mm

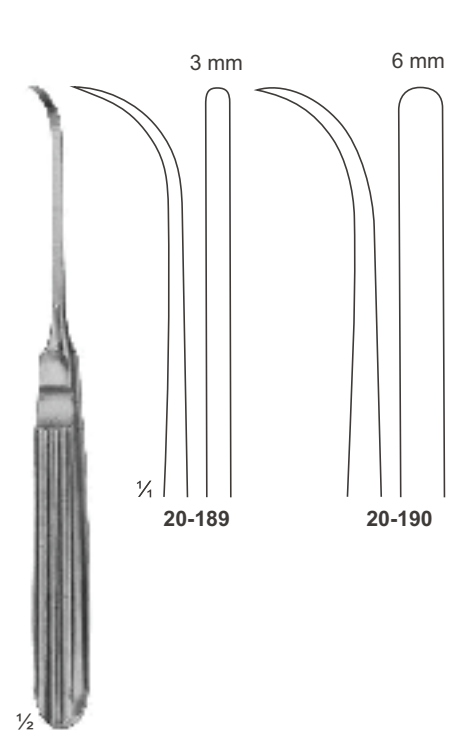

20-189 - 190
170 mm

Raspatories

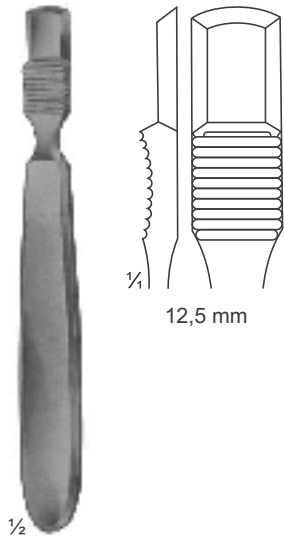

20-191
FARABEU
140 mm

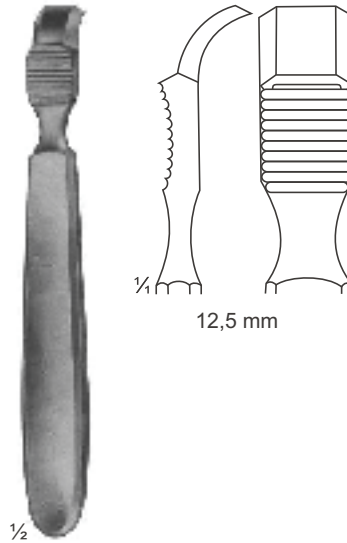

20-192
FARABEU
140 mm

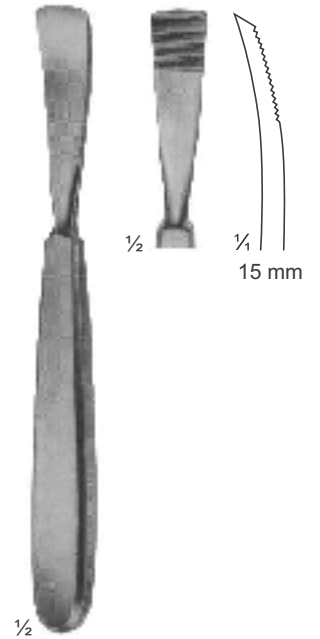

20-193
JANSEN
165 mm

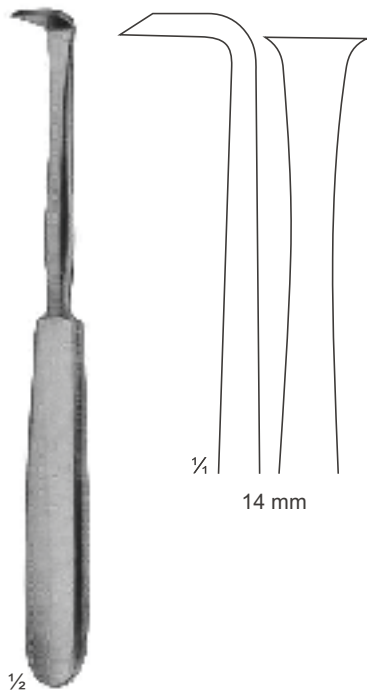

20-194
LANGENBACK
180 mm

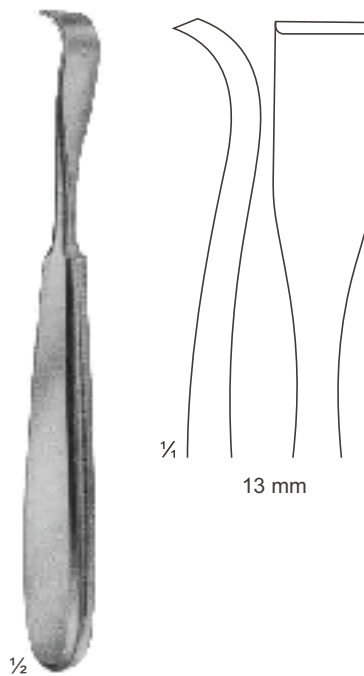

20-195
SCHNEIDER
175 mm

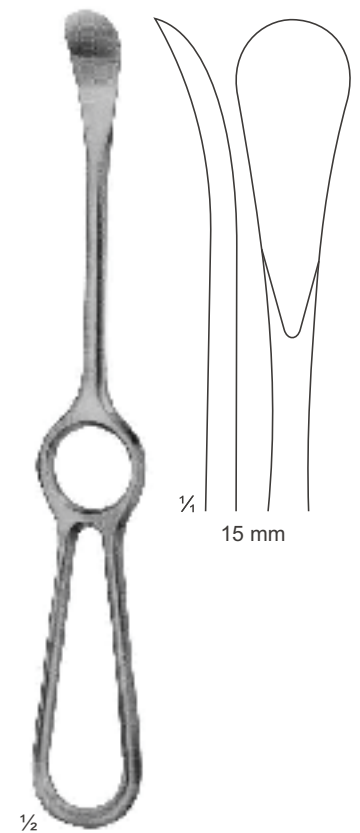

20-196
SEDILLOT
215 mm

Raspatories

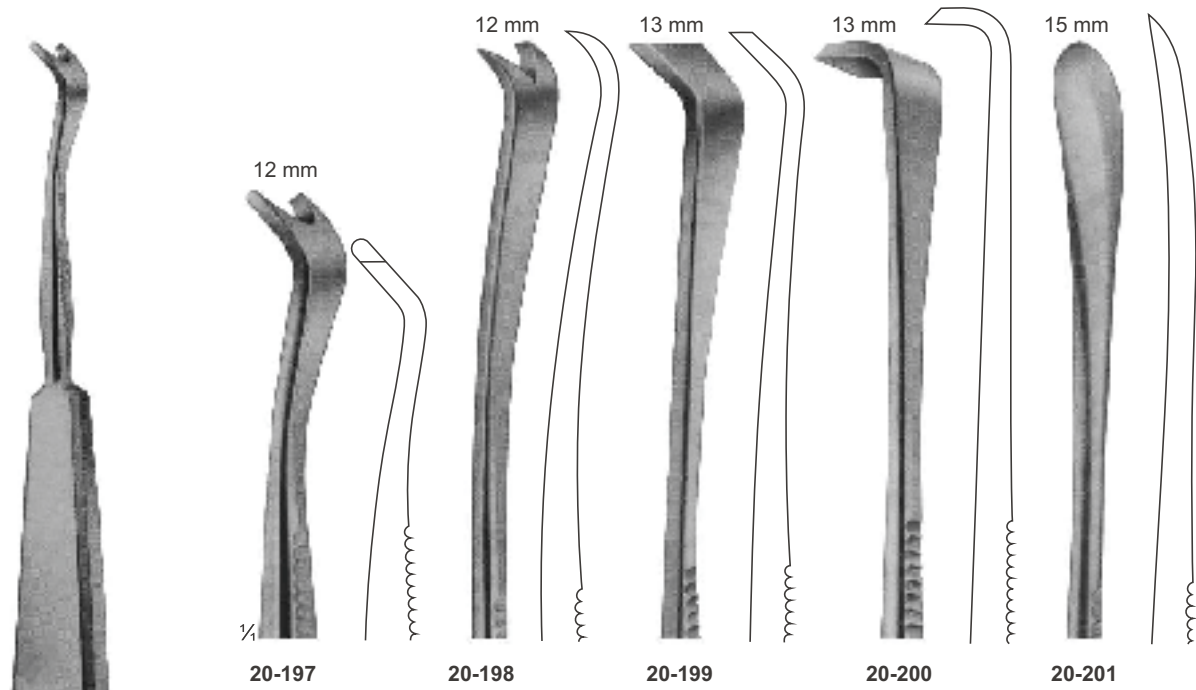

1/2
20-197 - 201
SEMB
230 mm

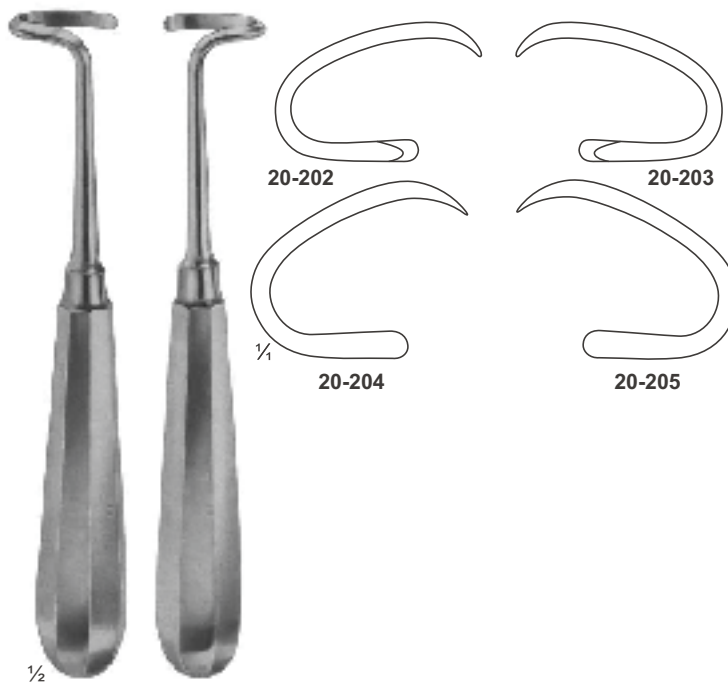

20-202 - 203
DOYEN
for children
20-204 - 205
for adults
175 mm

20-206 - 207
DOYEN
240 mm

Raspatories with HARTPRESS-handle

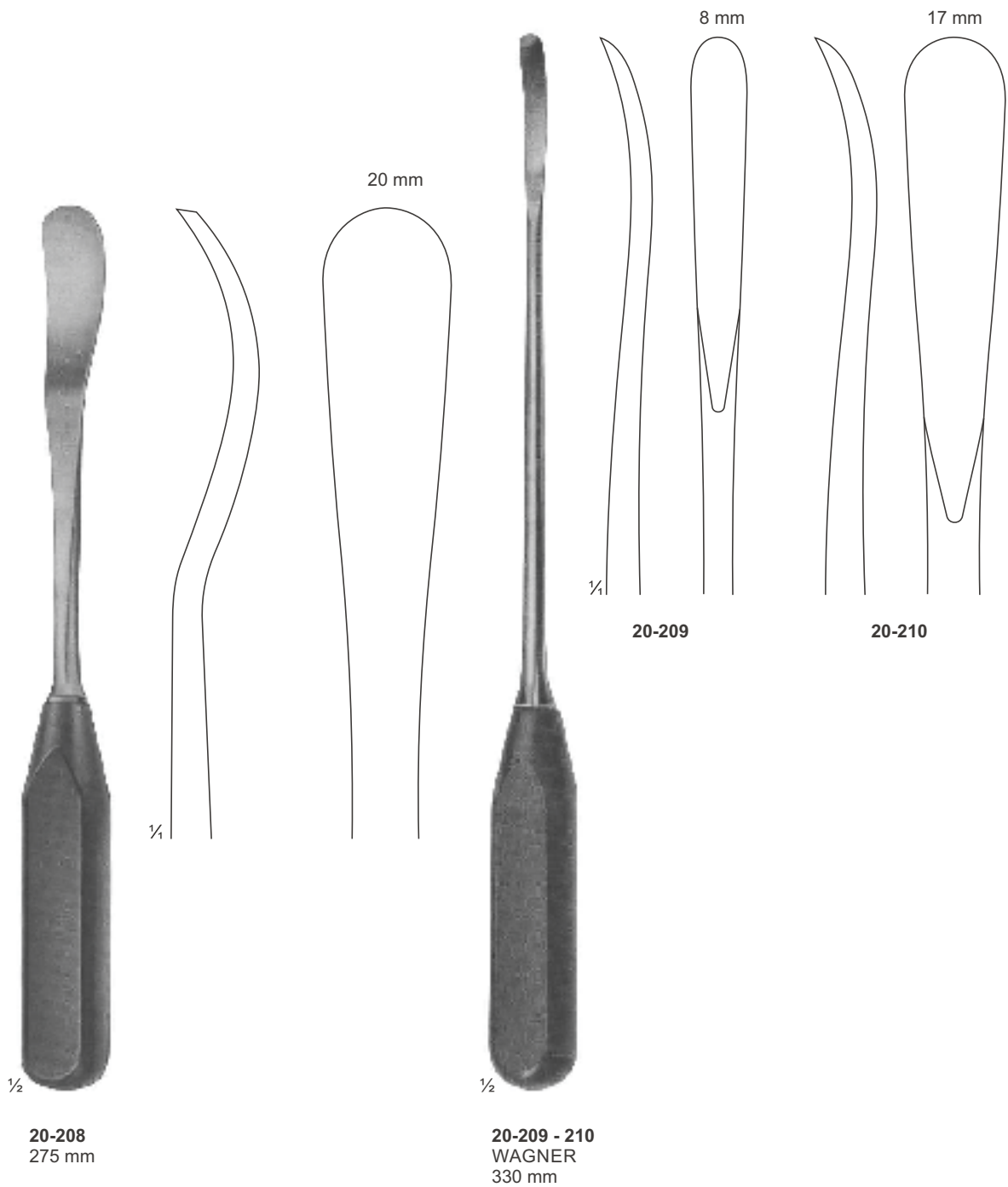

Bone File and Rasps

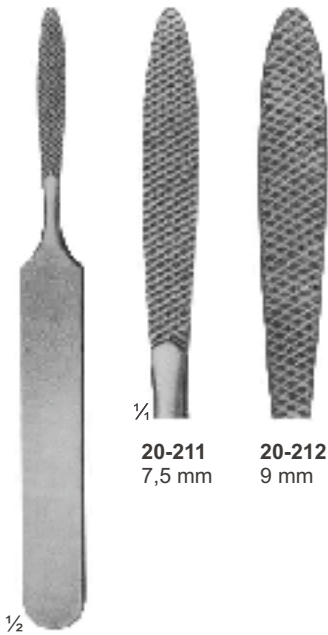

20-211
7,5 mm

20-212
9 mm

1/2

20-211
JOSEPH
fine, chequered

20-212
coarse, chequered
165 mm

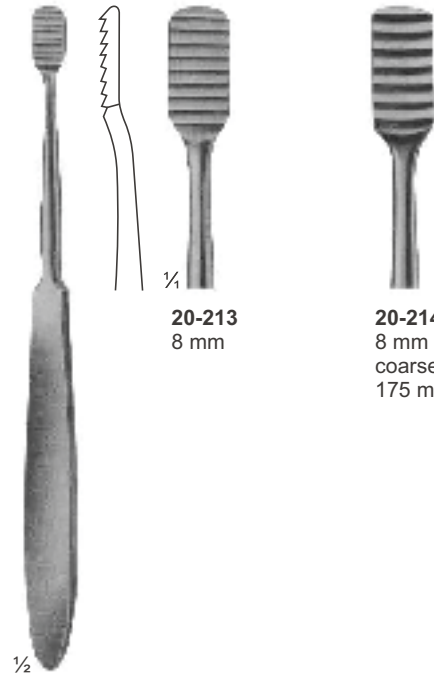

20-213
8 mm

20-214
8 mm
coarse, teeth
175 mm

1/2

20-213
LEWIS
fine, teeth



20-216
9 mm

1/2

20-215
MALTZ
down stroke
180 mm

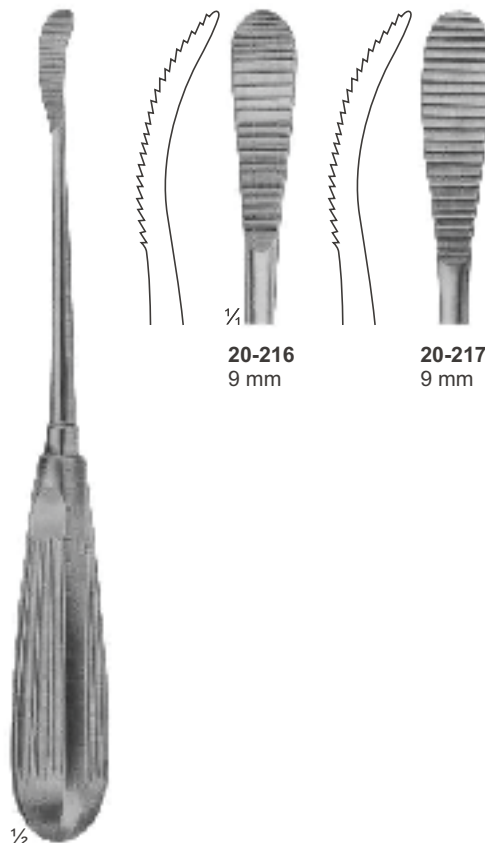

20-216
9 mm

20-217
9 mm

1/2

20-216
AUFRICHT
up stroke
20-217
down stroke
220 mm



20-219
6,5 mm

1/2

20-218
GALLAHER
190 mm

Bone File and Rasps

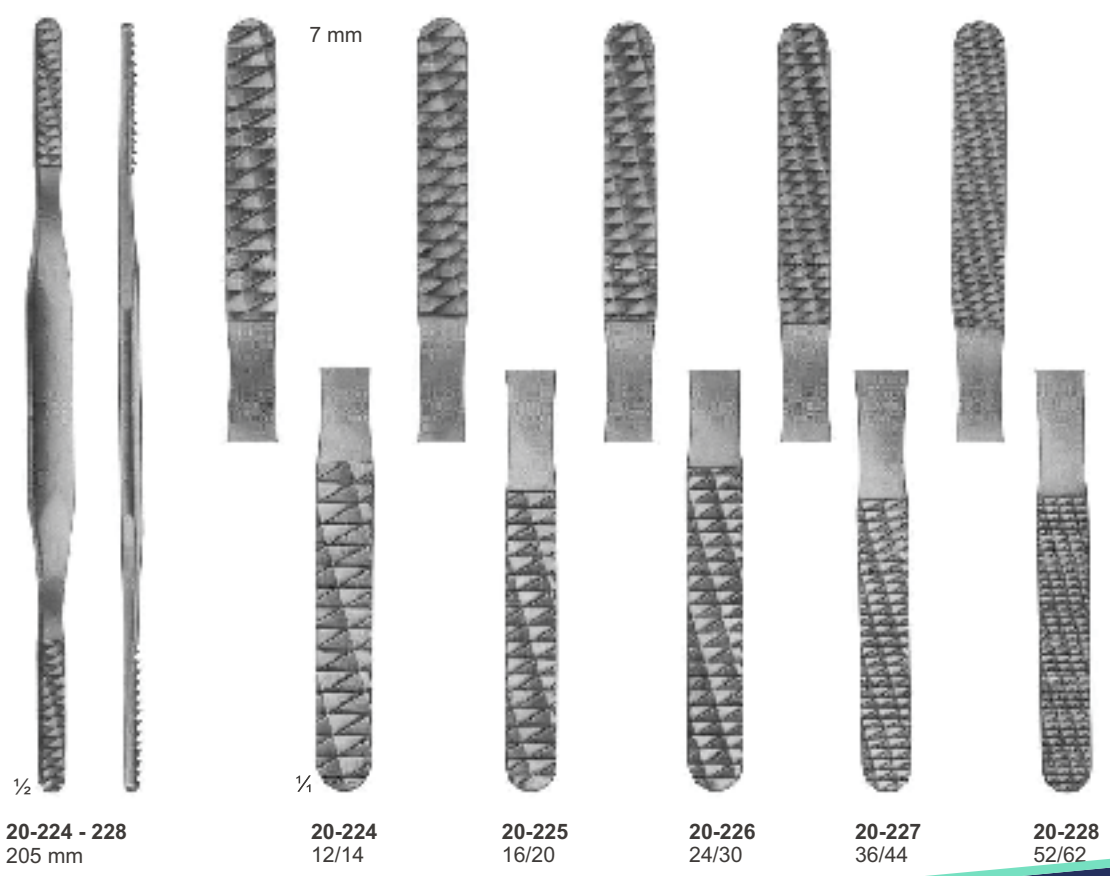
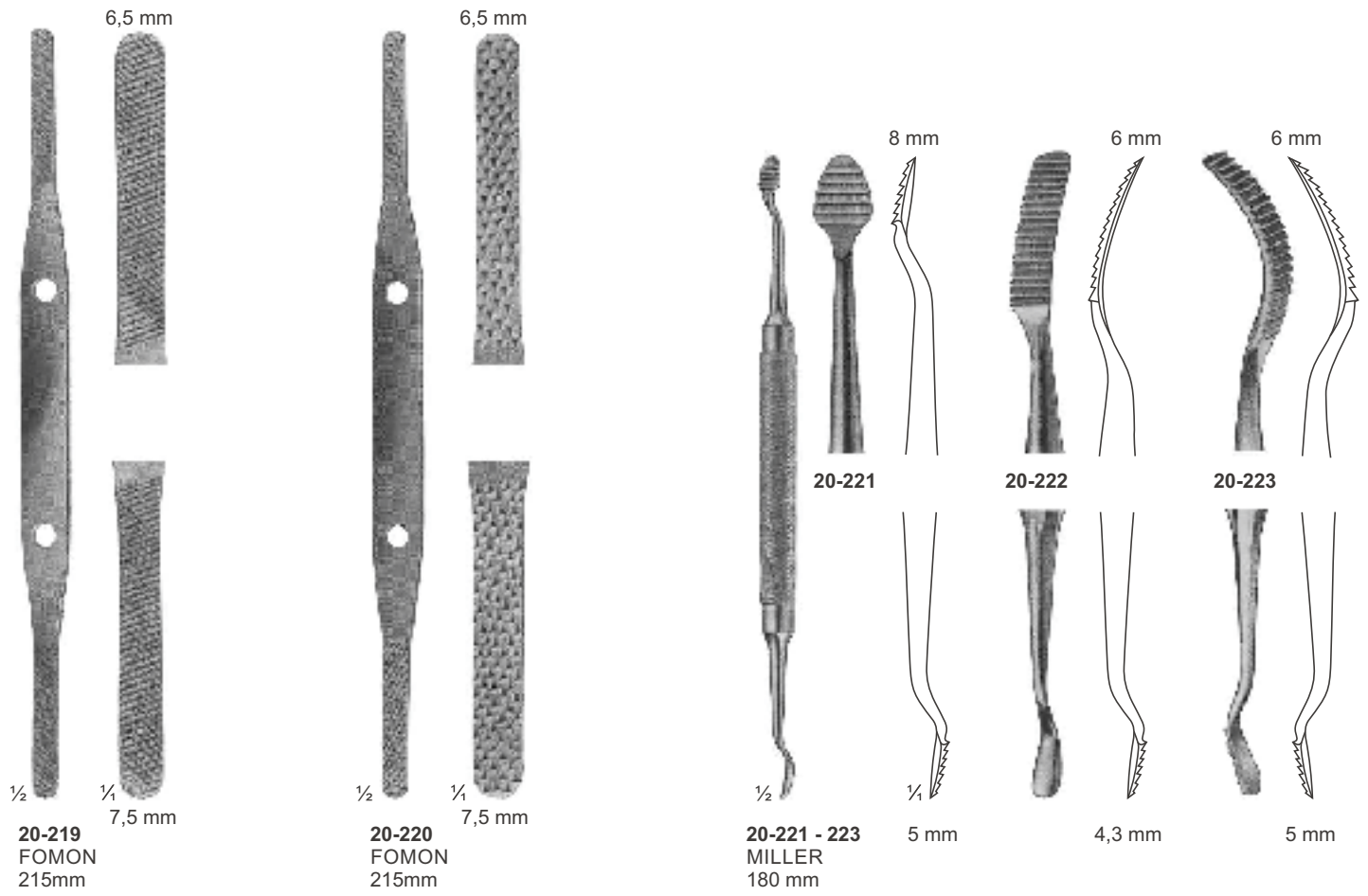

Bone File and Rasps

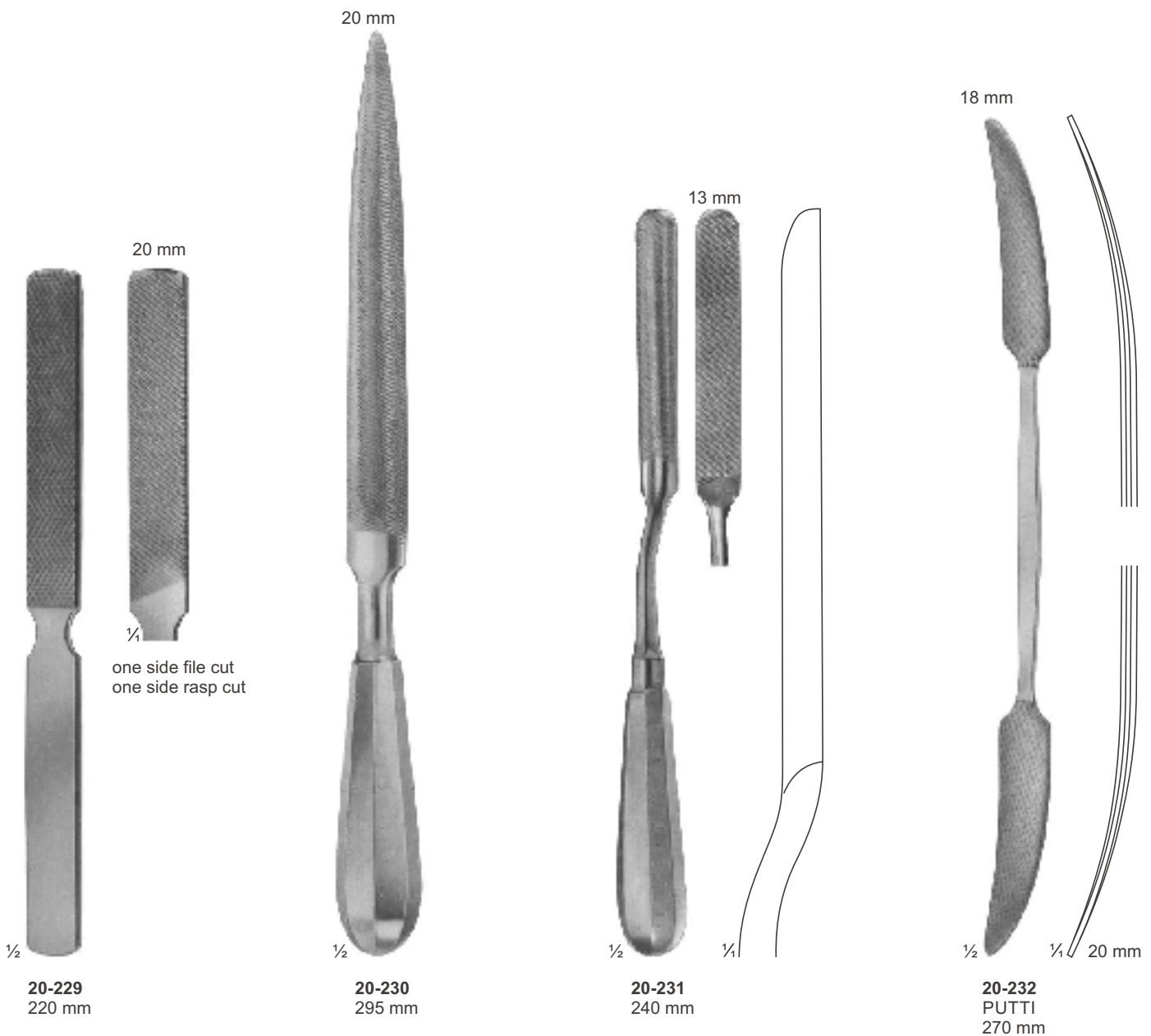

Bone Curettes

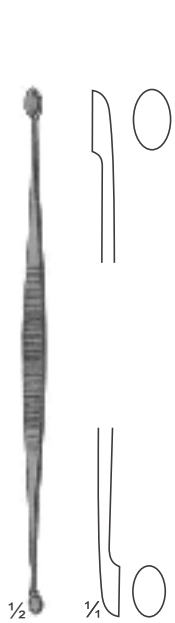

20-233
JACOBSON
140 mm



20-234
MARTINI
140 mm

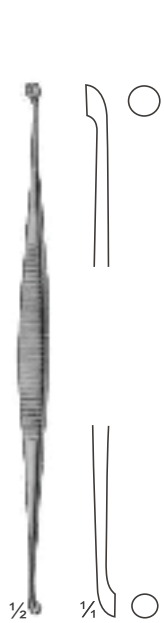

20-235
MARTINI
140 mm



20-236
WILLIGER
145 mm



20-237
JANSEN
160 mm



20-238
BARTH
180 mm

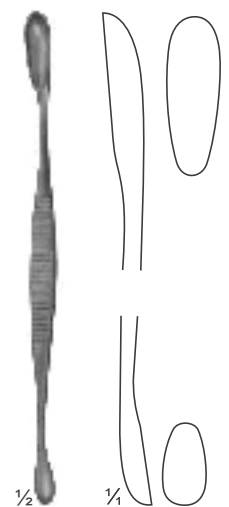

20-239
VOLKMANN
130 mm

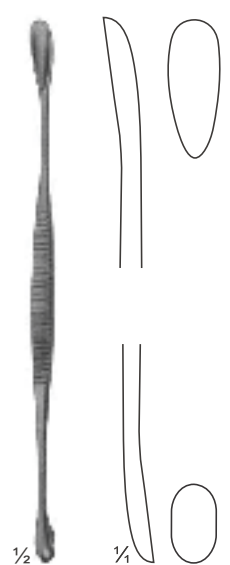

20-240
VOLKMANN
145 mm

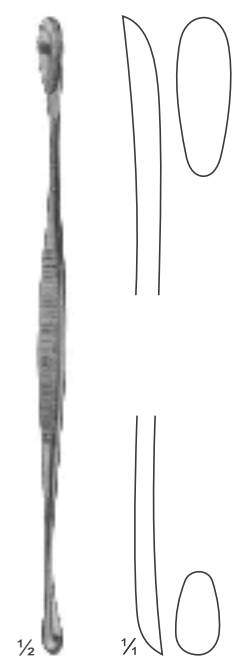

20-241
VOLKMANN
170 mm

Bone Curettes



20-242
JANSEN
160 mm



20-243
HEMINGWAY
170 mm

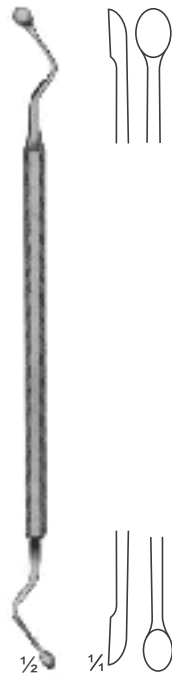

20-244
HEMINGWAY
175 mm



20-245
LUCAS
180 mm



20-246
LUCAS
185 mm

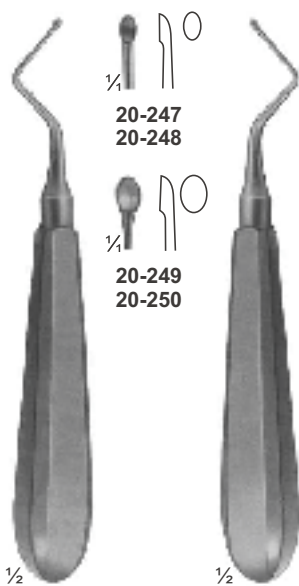

20-247 - 248
KERPEL
145 mm



20-249 - 250
KERPEL
145 mm

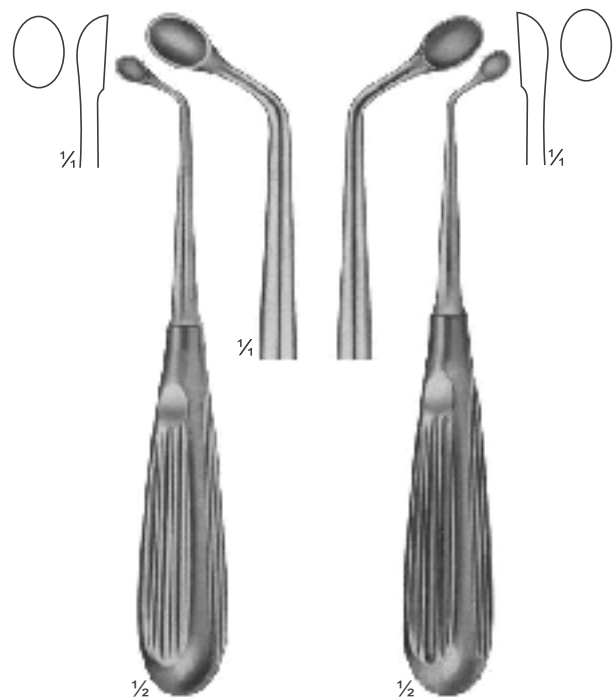

20-251
UFFENDORDE
170 mm

20-252
UFFENDORDE
170 mm

Bone Currettes



1/2

20-253 - 259
BRUNS
165 mm



20-253
3 mm
Fig: 000



20-254
4 mm
00



20-255
5 mm
0



20-256
6 mm
Fig: 1



20-257
8 mm
2



20-258
10 mm
3

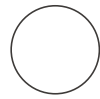

20-259
12 mm
4



1/2

20-260 - 266
SCHEDE
170 mm



20-260
2,5 mm
Fig: 000



20-261
3,4 mm
00



20-262
4,2 mm
0



20-263
5,2 mm
Fig: 1



20-264
6,3 mm
2



20-265
7,4 mm
3



20-266
8 mm
4



1/2

20-267 - 276
VOLKMANN
170 mm



20-267
2,8 mm
Fig: 0000



20-268
3,6 mm
000



20-269
4,4 mm
00



20-270
5,2 mm
0



20-271
6,8 mm
1



20-272
8,5 mm
Fig: 2

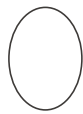

20-273
10 mm
3



20-274
11,5 mm
4



20-275
13 mm
5

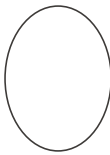

20-276
14,5 mm
6



1/2

20-277 - 278
WILLIGER
170 mm



20-277
3,4 mm
Fig: 00



20-278
5,2 mm
1

Bone Currettes

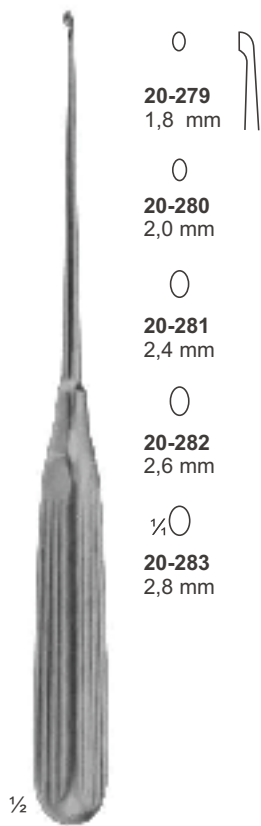

○
20-279
1,8 mm

○
20-280
2,0 mm

○
20-281
2,4 mm

○
20-282
2,6 mm

¼○
20-283
2,8 mm

½

20-279 - 283
LEMPERT
215 mm

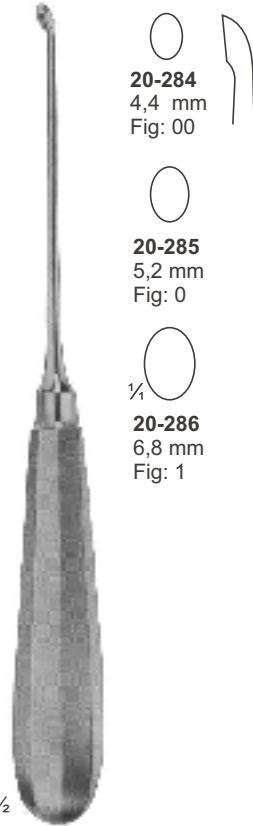

○
20-284
4,4 mm
Fig: 00

○
20-285
5,2 mm
Fig: 0

¼○
20-286
6,8 mm
Fig: 1

½

20-284 - 286
HALLE
215 mm

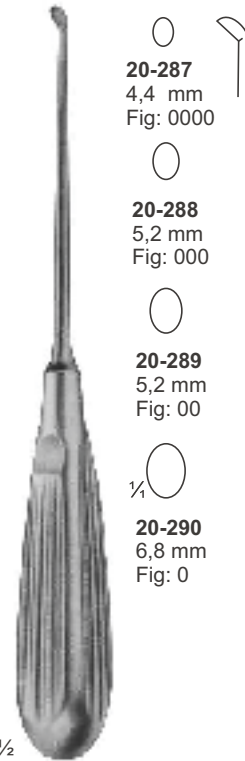

○
20-287
4,4 mm
Fig: 0000

○
20-288
5,2 mm
Fig: 000

○
20-289
5,2 mm
Fig: 00

¼○
20-290
6,8 mm
Fig: 0

½

20-287 - 290
DAUBENSPECK
200 mm



○
20-291
3,6 mm
Fig: 000

○
20-292
4,4 mm
Fig: 00

○
20-293
5,2 mm
Fig: 0

¼○
20-294
6,8 mm
Fig: 1

½

20-291 - 294
250 mm



○
20-295
3,6 mm
Fig: 000

○
20-296
4,4 mm
Fig: 00

○
20-297
5,2 mm
Fig: 0

¼○
20-298
6,8 mm
Fig: 1

½

20-295 - 298
250 mm



○
20-299
3 mm

○
20-300
4 mm

¼○
20-301
5 mm

½

20-299 - 301
BUSHE
250 mm

Bone Currettes

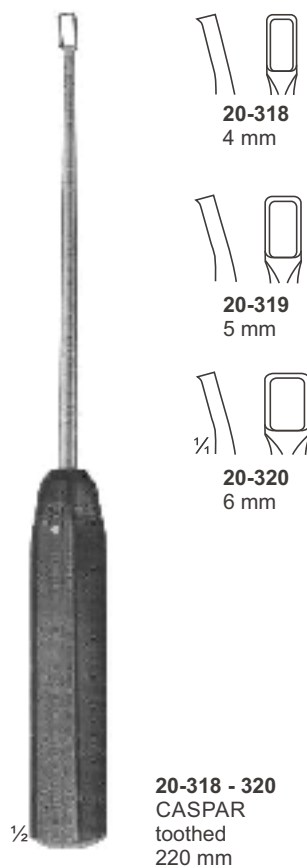
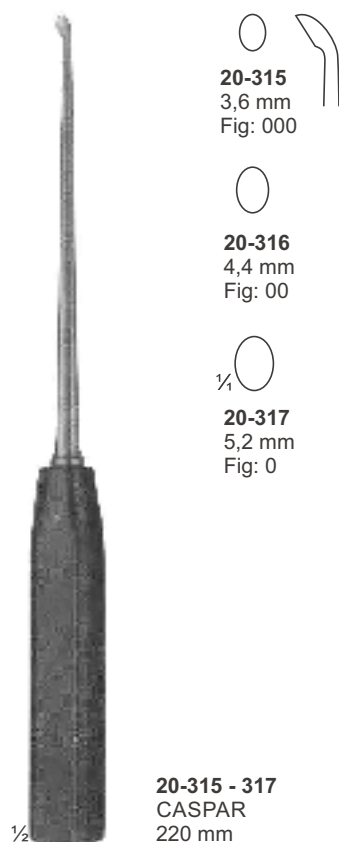
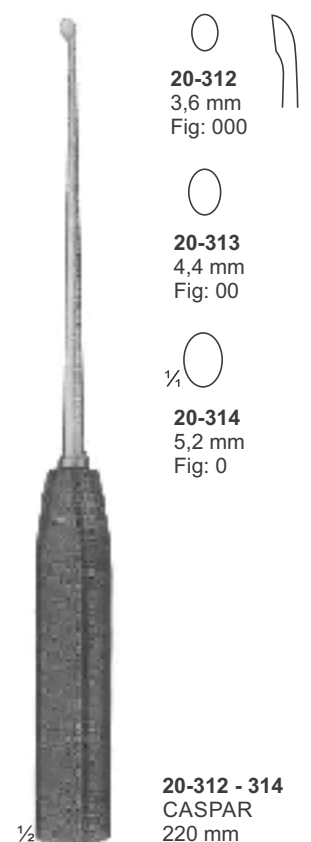
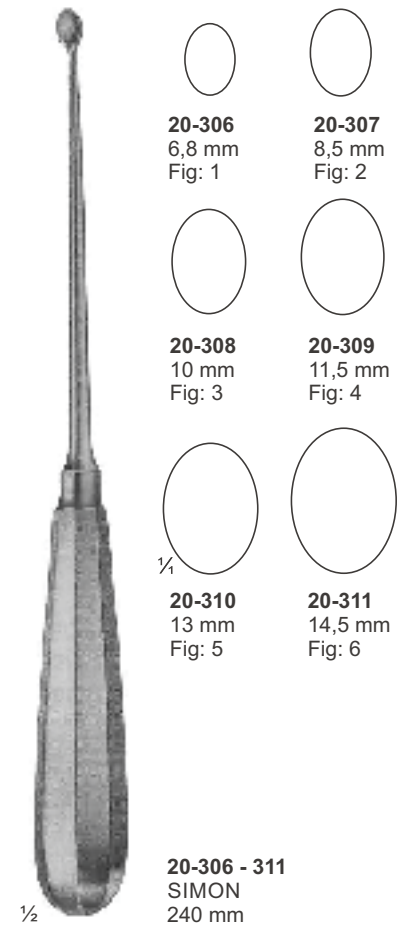

Bone Curettes

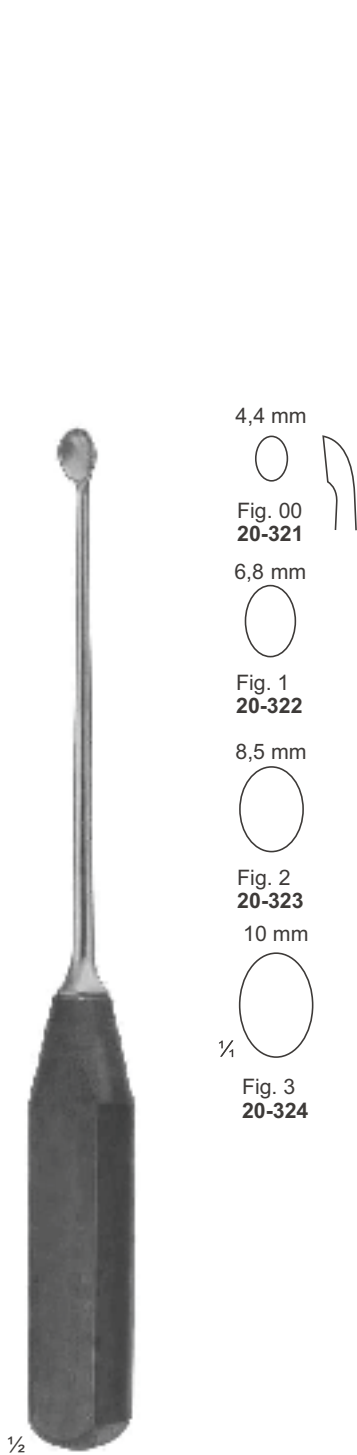

20-321 - 324
270 mm

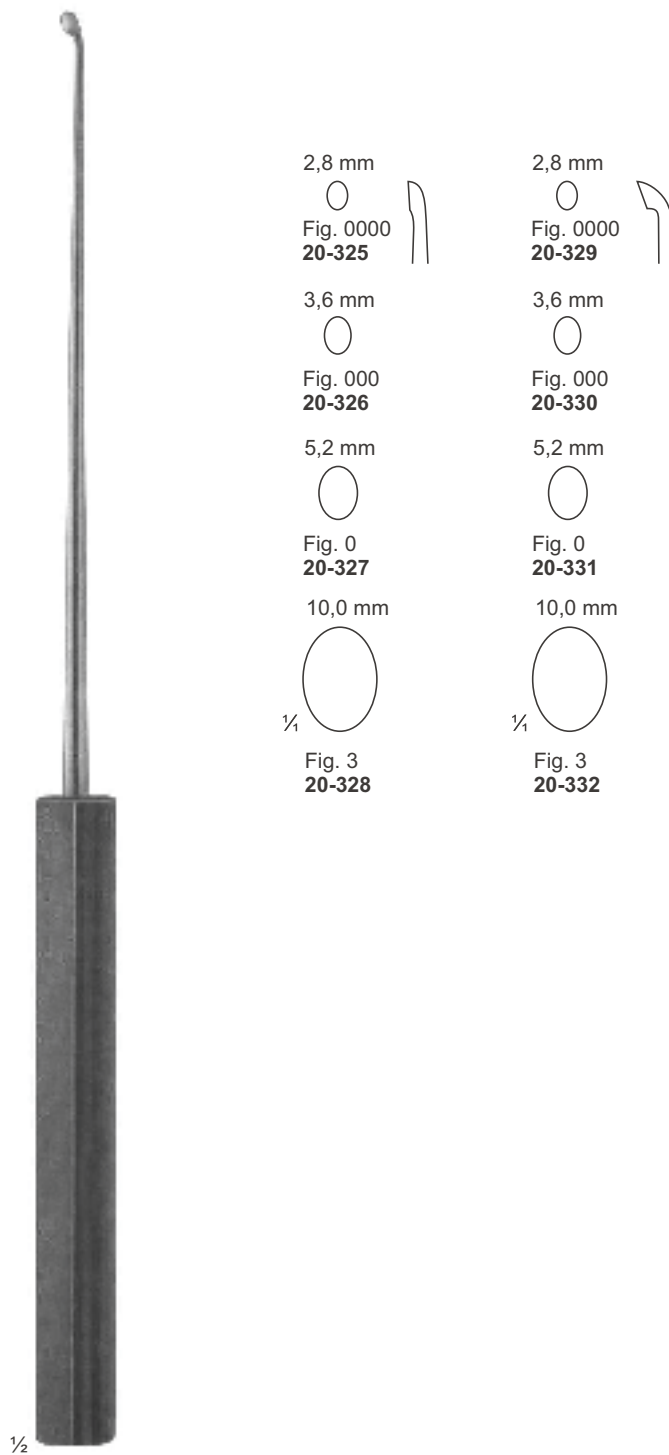

20-325 - 332
SYPERT
380 mm

Mallets



∅ 20 mm

½

21-101
MEAD
185 g
with interchangeable
plastic disks
190 mm
21-102
pair of spare disks



½

21-103
140 g
with interchangeable
plastic disks
185 mm
21-104
pair of spare disks



∅ 25 mm

½

21-105
COTTLE
140 g
1 Seite convex
1 Side convex
185 mm



∅ 22 mm

½

21-106
165 g
lead filled head
190 mm

Mallets



21-107
HAJEK
140 g
215 mm



21-108
215 g
with interchangeable
plastic disks
245 mm
21-109
pair of spare disks

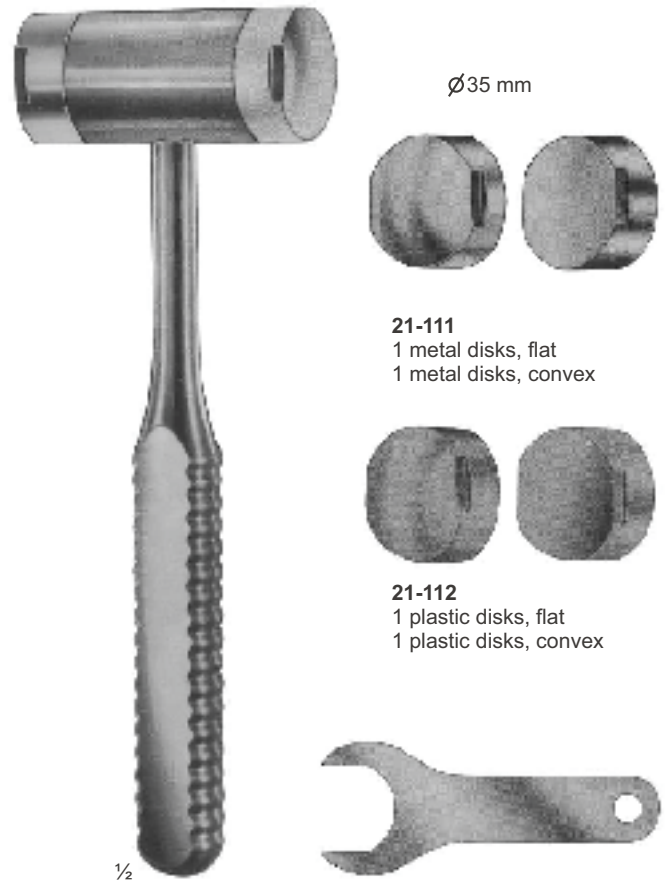

21-110 - 113
WAGNER
complete with:
1 pair of metal disks and
1 pair of plastic disks and
1 wrench 566
235 mm

21-111
1 metal disks, flat
1 metal disks, convex

21-112
1 plastic disks, flat
1 plastic disks, convex

21-113
Wrench

Mallet without disks 130 g

Mallets



21-114
BERGMANN
245 mm



21-115
BERGMANN
235 mm



21-116
OMBREDANNE
240 mm

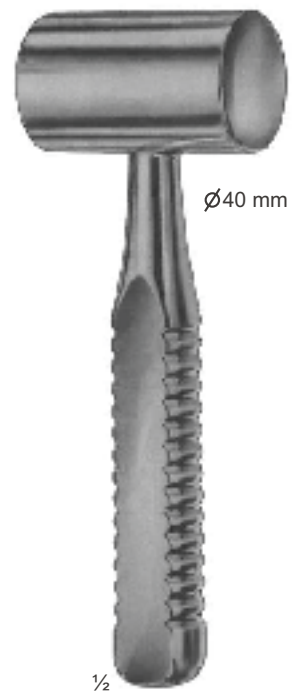

21-117
HEATH
copper filled head
700 g
185 mm

Tampers - Osteotomes, Chisels and Gouges

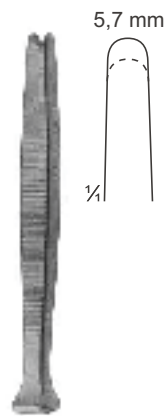

21-118
Haase
100 mm

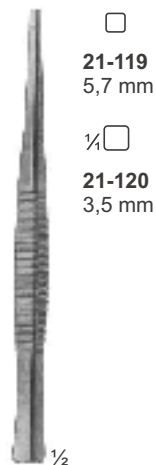

21-119 - 120
PASSOW
120 mm



21-121 - 123
CASPER
200 mm



21-124 - 126
200 mm

- 21-121
ø3 mm
- 21-122
ø5 mm
- 1/4 21-123
ø8 mm

- 21-124
ø12 mm
- 21-125
ø14 mm
- 1/4 21-126
ø16 mm

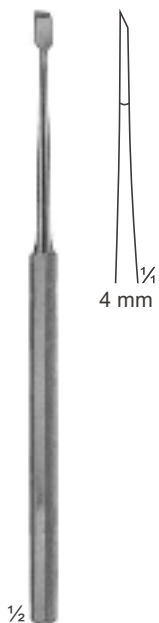

21-127
FREER
Chisel
160 mm

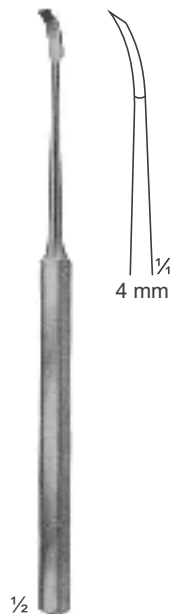

21-128
FREER
Chisel, curved
160 mm

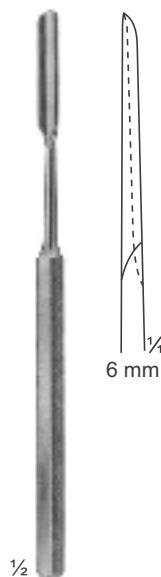

21-129
FREER
Gouge
150 mm

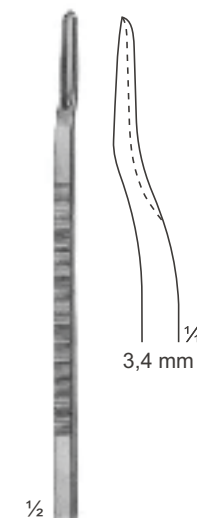

21-130
Scaphoid gouge,
downwards curved
135 mm

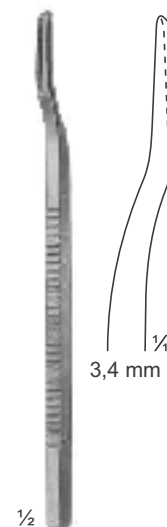

21-131
Scaphoid gouge,
upwards curved
135 mm

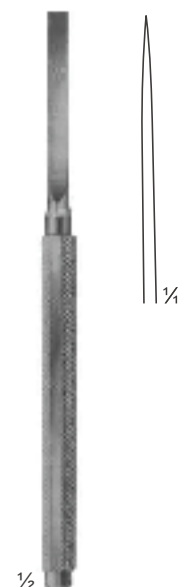

21-131A - 133
Mannerfelt
21-131A 4 mm
21-132 6 mm

Osteotomes Chisels and Gouges

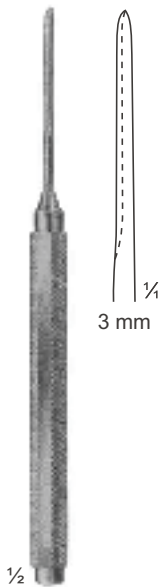

21-134
Mannerfelt
155 mm

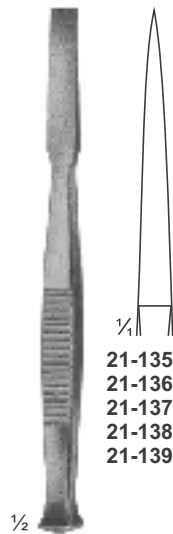

21-135 - 139
Osteotome
140 mm

21-135 4 mm
21-136 6 mm
21-137 8 mm
21-138 10 mm
21-139 12 mm

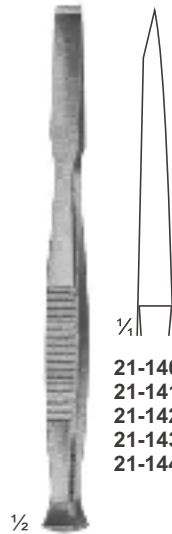

21-140 - 144
Chisels
140 mm

21-140 4 mm
21-141 6 mm
21-142 8 mm
21-143 10 mm
21-144 12 mm

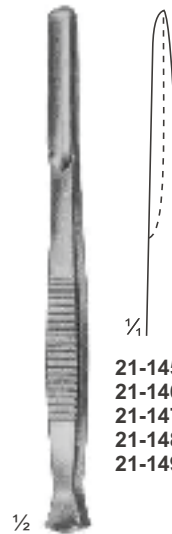

21-145 - 149
Gouges
140 mm

21-145 4 mm
21-146 6 mm
21-147 8 mm
21-148 10 mm
21-149 12 mm

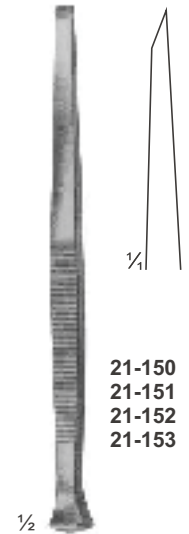

PARTSCH
21-150 - 153
Chisels
140 mm

21-150 3 mm
21-151 4 mm
21-152 5 mm
21-153 6 mm

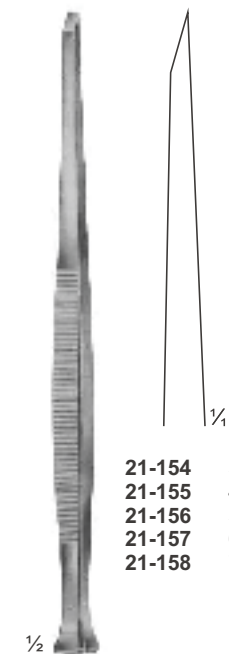

PARTSCH
21-154 - 158
Chisels
170 mm

21-154 3 mm
21-155 4 mm
21-156 5 mm
21-157 6 mm
21-158 7 mm

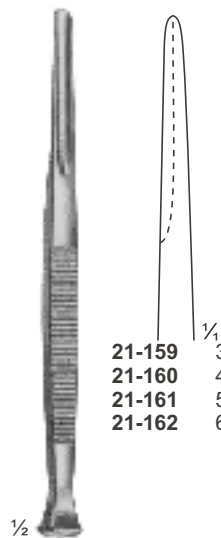

PARTSCH
21-159 - 162
Gouges
140 mm

21-159 3 mm
21-160 4 mm
21-161 5 mm
21-162 6 mm

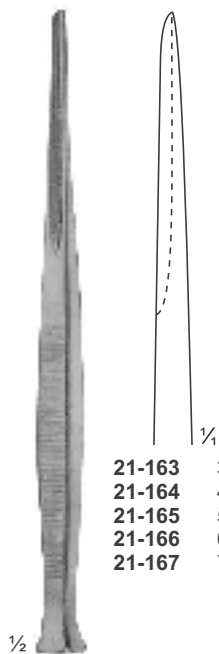

PARTSCH
21-163 - 167
Gouges
170 mm

21-163 3 mm
21-164 4 mm
21-165 5 mm
21-166 6 mm
21-167 7 mm

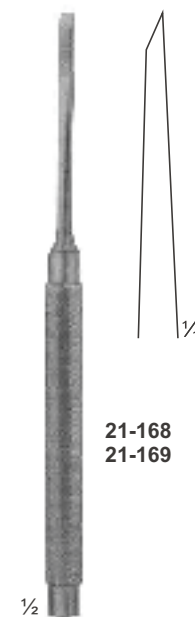

LUCAS
21-168 - 169
Chisels
160 mm

21-168 4 mm
21-169 6 mm

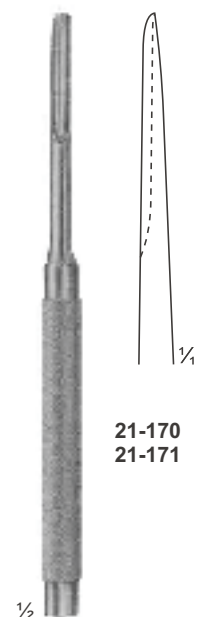

LUCAS
21-170 - 171
Gouges
160 mm

21-170 3 mm
21-171 5 mm

Osteotomes Chisels and Gouges

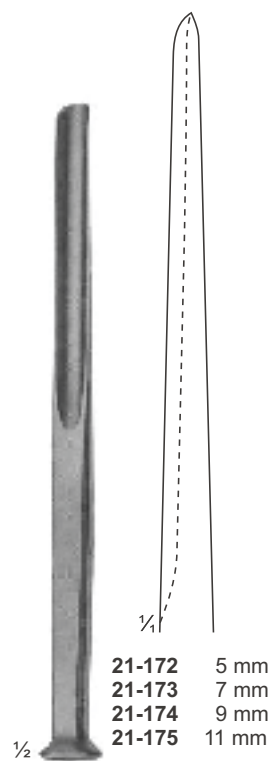

ALEXANDER
21-172 - 175
Gouges
170 mm

21-172 5 mm
21-173 7 mm
21-174 9 mm
21-175 11 mm



LAMBOTTE
21-176 - 181
Osteotome
125 mm

21-176 4 mm
21-177 6 mm
21-178 8 mm
21-179 10 mm
21-180 12 mm
21-181 15 mm

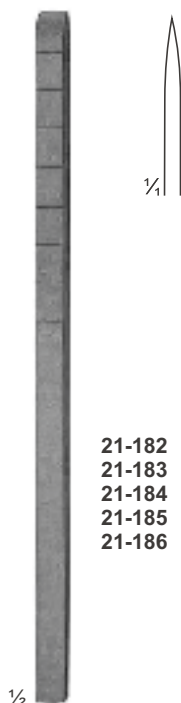

COTTLE
21-182 - 186
Osteotome with depth
markings
180 mm

21-182 4 mm
21-183 6 mm
21-184 8 mm
21-185 10 mm
21-186 12 mm

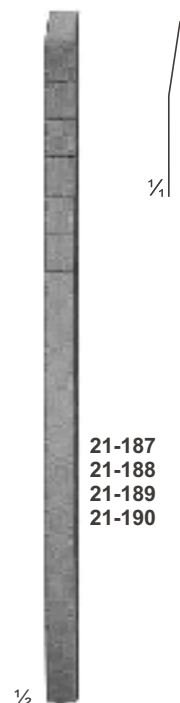

COTTLE
21-187 - 190
Chisel-Osteotomes
with depth markings
180 mm

21-187 4 mm
21-188 7 mm
21-189 9 mm
21-190 12 mm



COTTLE
21-191
Fishtail Chisel,
with protected ends
180 mm

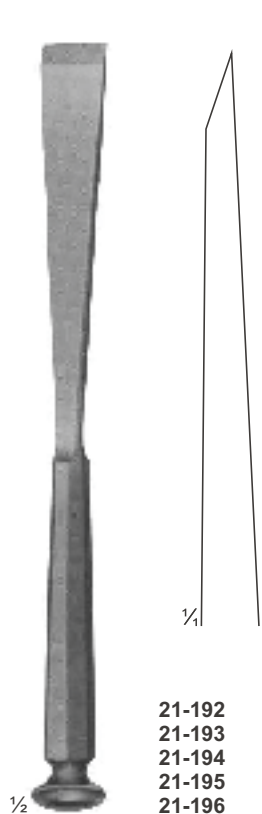

STILLE
21-192 - 196
Chisels
205 mm

21-192 10 mm
21-193 12 mm
21-194 15 mm
21-195 20 mm
21-196 25 mm

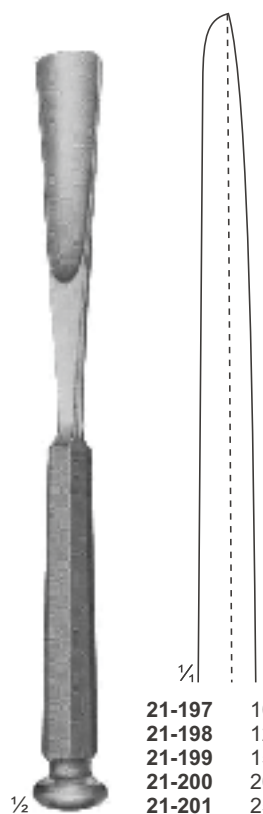

STILLE
21-197 - 201
Gouges
205 mm

21-197 10 mm
21-198 12 mm
21-199 15 mm
21-200 20 mm
21-201 25 mm

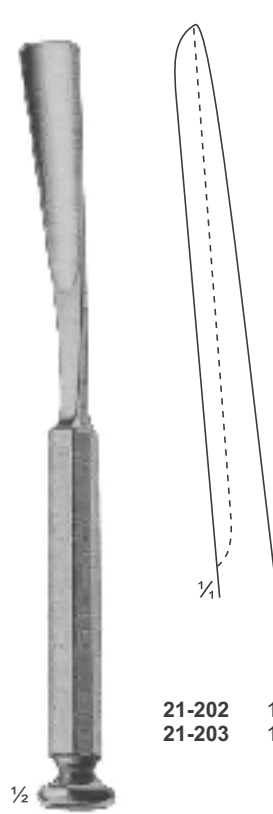

WALTER
21-202 - 203
Osteotomes
gouges for taking
grafts from the rib
205 mm

21-202 10 mm
21-203 15 mm

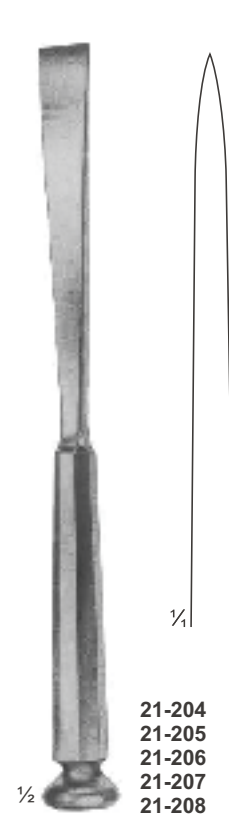

STILLE
21-204 - 208
Osteotomes
205 mm

21-204 8 mm
21-205 12 mm
21-206 15 mm
21-207 20 mm
21-208 25 mm

Osteotomes

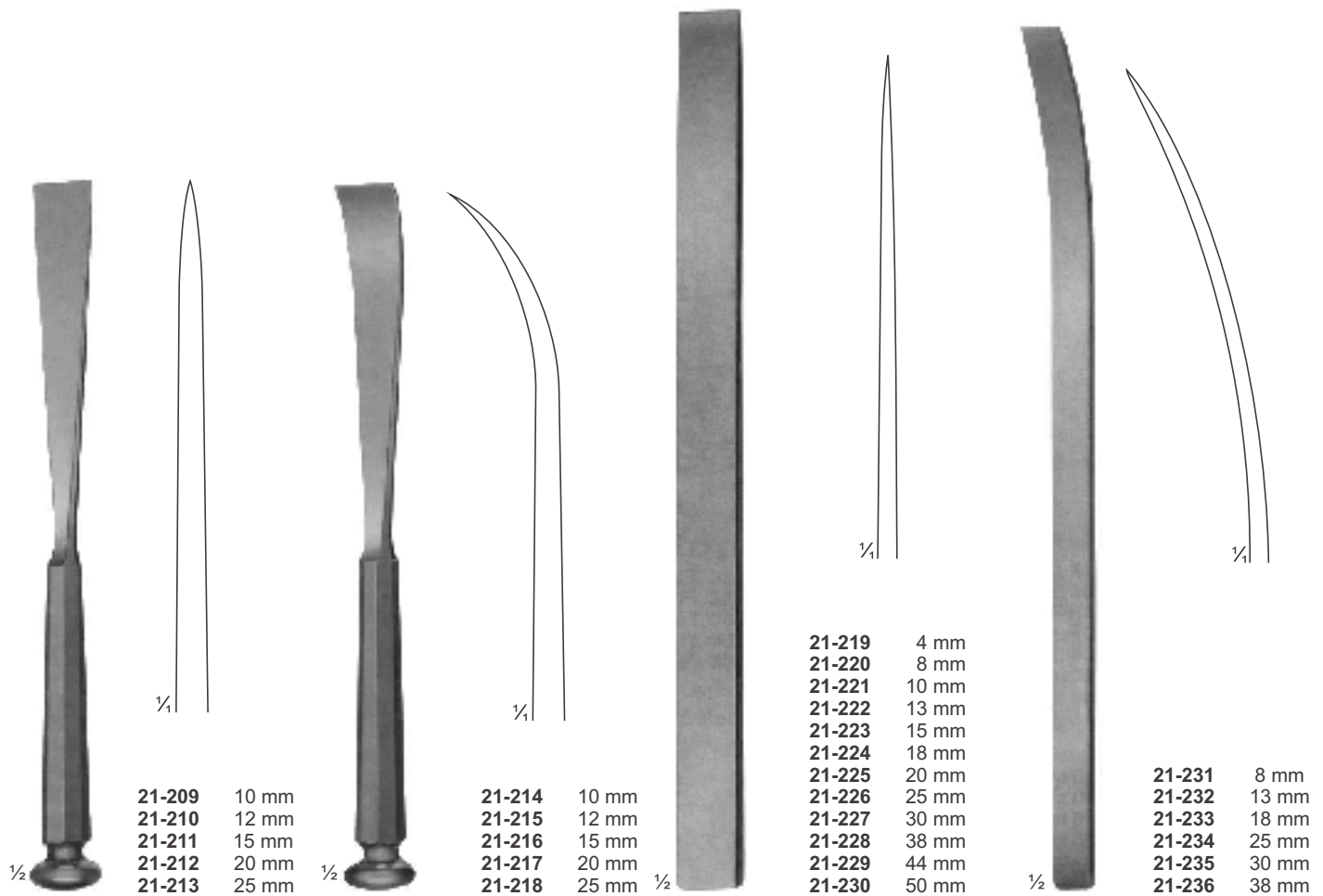







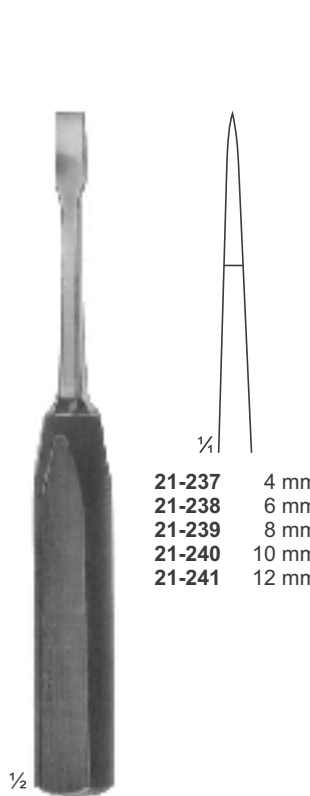

STILLE
21-209 - 213
 Osteotomes
 205 mm

STILLE
21-214 - 218
 Osteotomes, curved
 205 mm

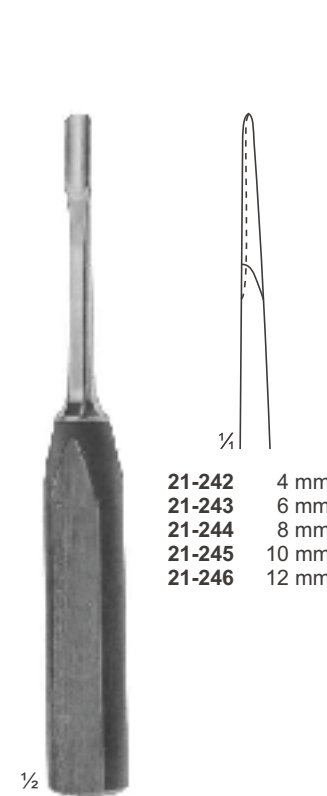
LAMBOTTE
21-219 - 230
 Osteotomes
 245 mm

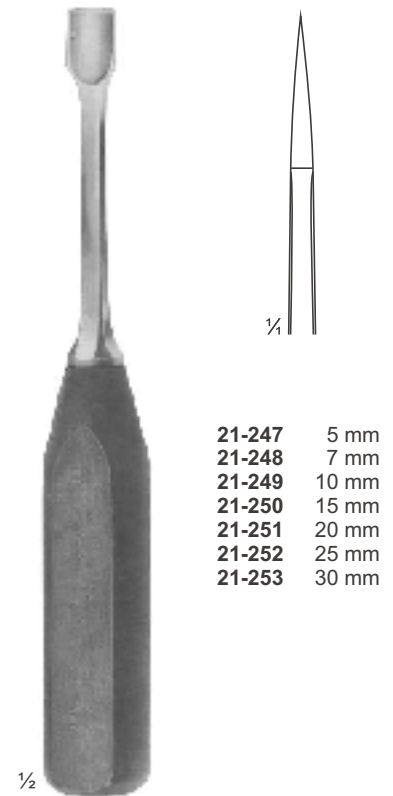
LAMBOTTE
21-231 - 236
 Osteotomes, curved
 245 mm

Osteotomes, Chisels and Gouges with HARTPRESS -handle

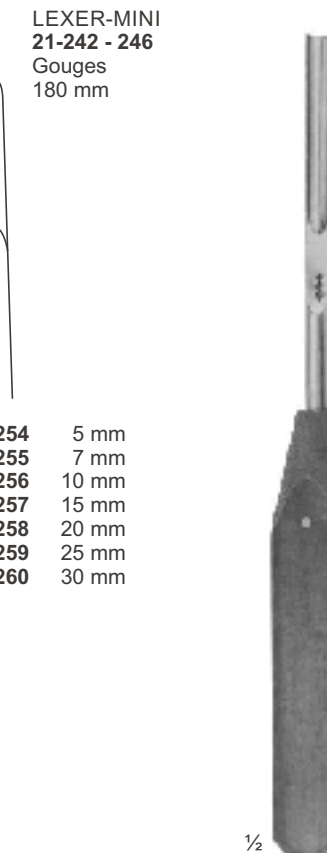
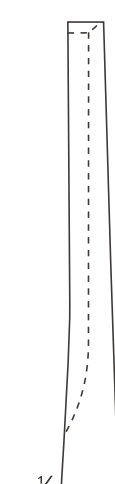
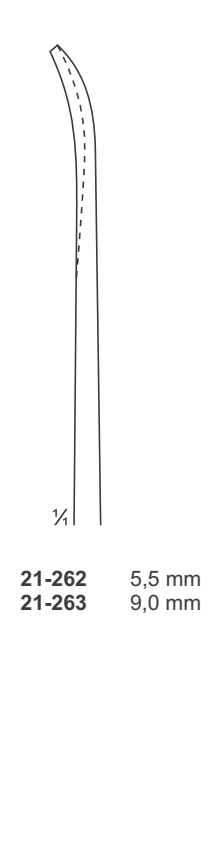
| | | | | | |
|---|---|--|--|---|---|
|  <p>1/2</p> |  <p>1/4</p> <ul style="list-style-type: none"> 21-237 4 mm 21-238 6 mm 21-239 8 mm 21-240 10 mm 21-241 12 mm |  <p>1/2</p> |  <p>1/4</p> <ul style="list-style-type: none"> 21-242 4 mm 21-243 6 mm 21-244 8 mm 21-245 10 mm 21-246 12 mm |  <p>1/2</p> |  <p>1/4</p> <ul style="list-style-type: none"> 21-247 5 mm 21-248 7 mm 21-249 10 mm 21-250 15 mm 21-251 20 mm 21-252 25 mm 21-253 30 mm |
| <p>LEXER-MINI 21-237 - 241 Osteotomes 180 mm</p>  <p>1/2</p> |  <p>1/4</p> <ul style="list-style-type: none"> 21-254 5 mm 21-255 7 mm 21-256 10 mm 21-257 15 mm 21-258 20 mm 21-259 25 mm 21-260 30 mm | <p>LEXER-MINI 21-242 - 246 Gouges 180 mm</p>  <p>1/2</p> | <p>LEXER 21-247 - 253 Osteotomes 220 mm</p>  <p>1/4</p> |  <p>1/4</p> <ul style="list-style-type: none"> 21-262 5,5 mm 21-263 9,0 mm | |
| <p>LEXER 21-254 - 260 Gouges 220 mm</p> | <p>LEXER 21-261 Gouge for removing broken screws 220 mm</p> | <p>ZIELKE 21-262 - 263 Gouge for scoliose-operations 230 mm</p> | | | |

Osteotomes, Chisels and Gouges with HARTPRESS -handle

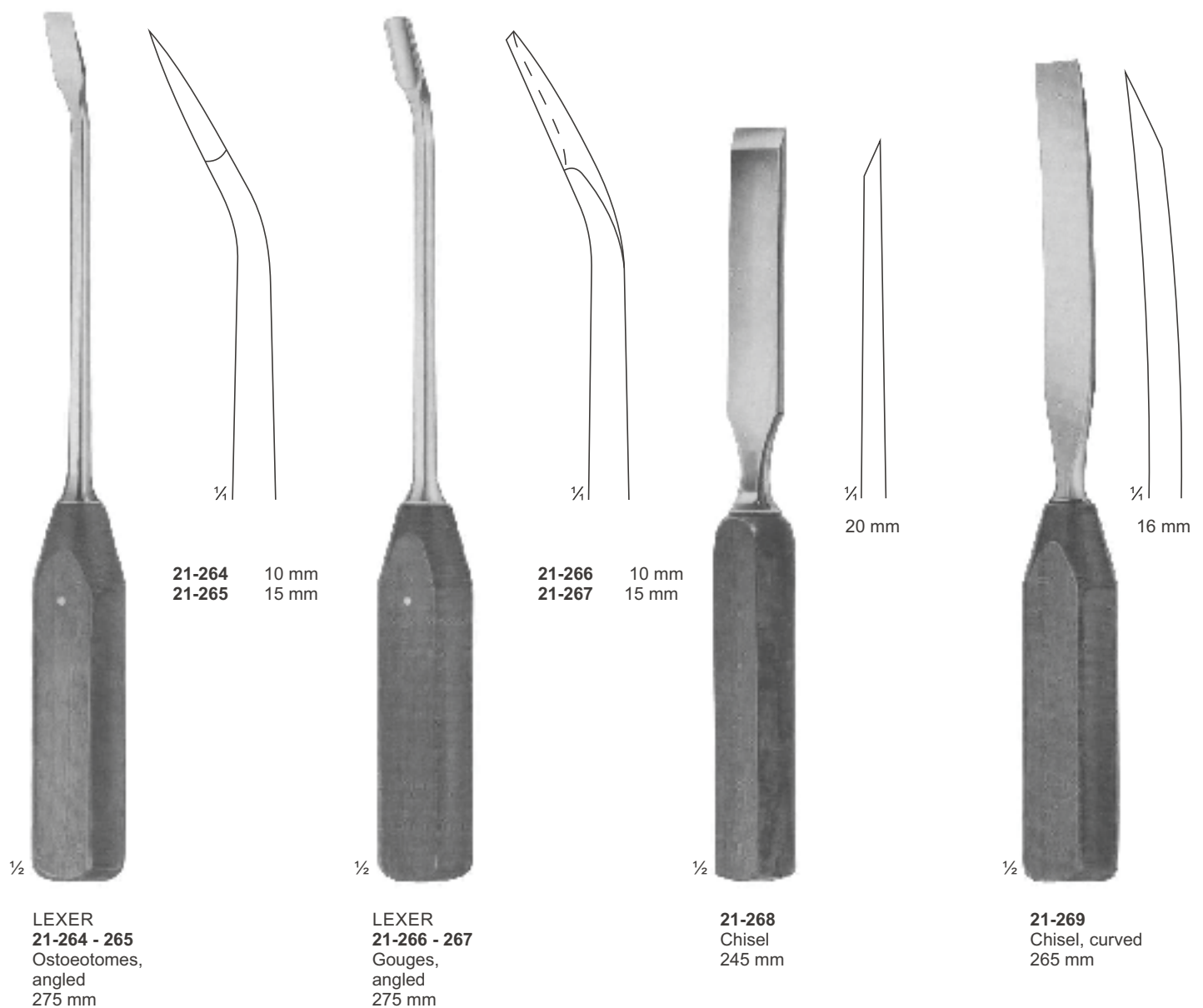

Reposition Forceps

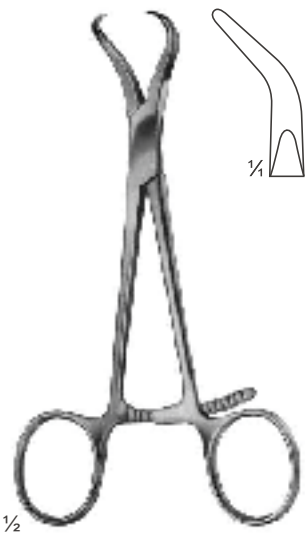

22-101
Reposition forceps,
for small fragments
135 mm

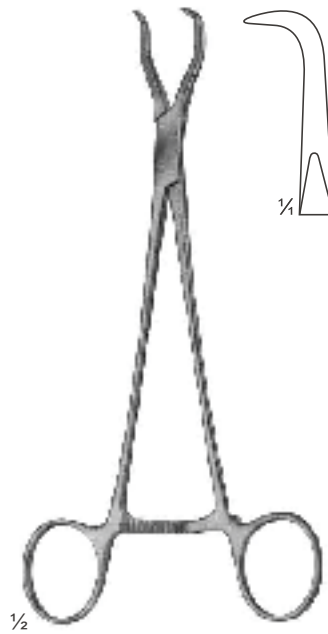

HAASE
22-102
Reposition forceps,
for mandibular
fractures
165 mm

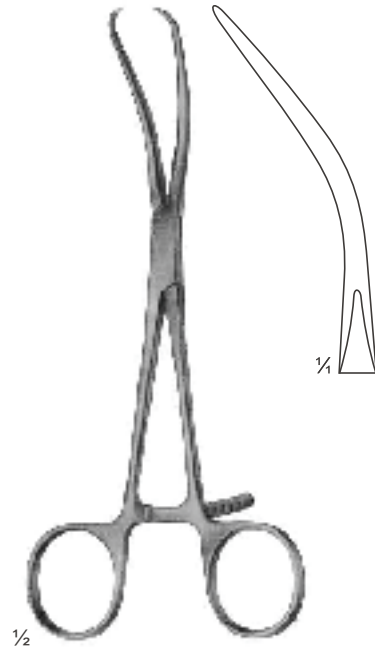

REILL
22-103
Reposition forceps,
170 mm



22-104
Reposition forceps
205 mm

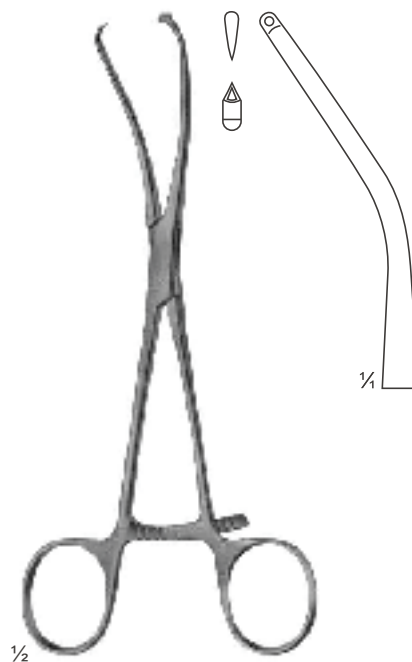

MEYER
22-105
Reposition forceps
for fingers, with drill
guide for KIRSCHNER
wires up to daim.1.0 mm
170 mm

Reposition Forceps, Bone Holding Forceps



22-106
Patella forceps
185 mm



22-107
Forceps with
ratchet fixation
140 mm



22-108
Forceps with
thread fixation
170 mm



22-109
Forceps with
thread fixation
235 mm

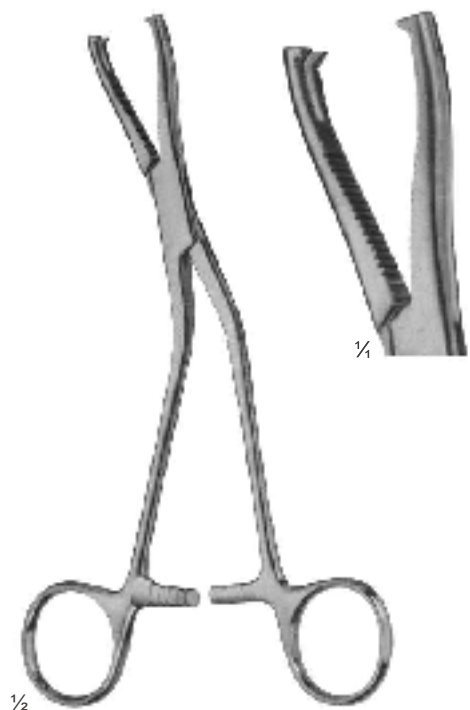

22-110
DINGMANN
185 mm

Bone Holding Forceps



22-111
Sequestrum
forceps
200 mm



22-112
VAN BUREN
Sequestrum
forceps
225 mm



22-113
LANGENBECK
Sequestrum
forceps
205 mm



22-114
FERGUSON
205 mm

Bone Holding Forceps

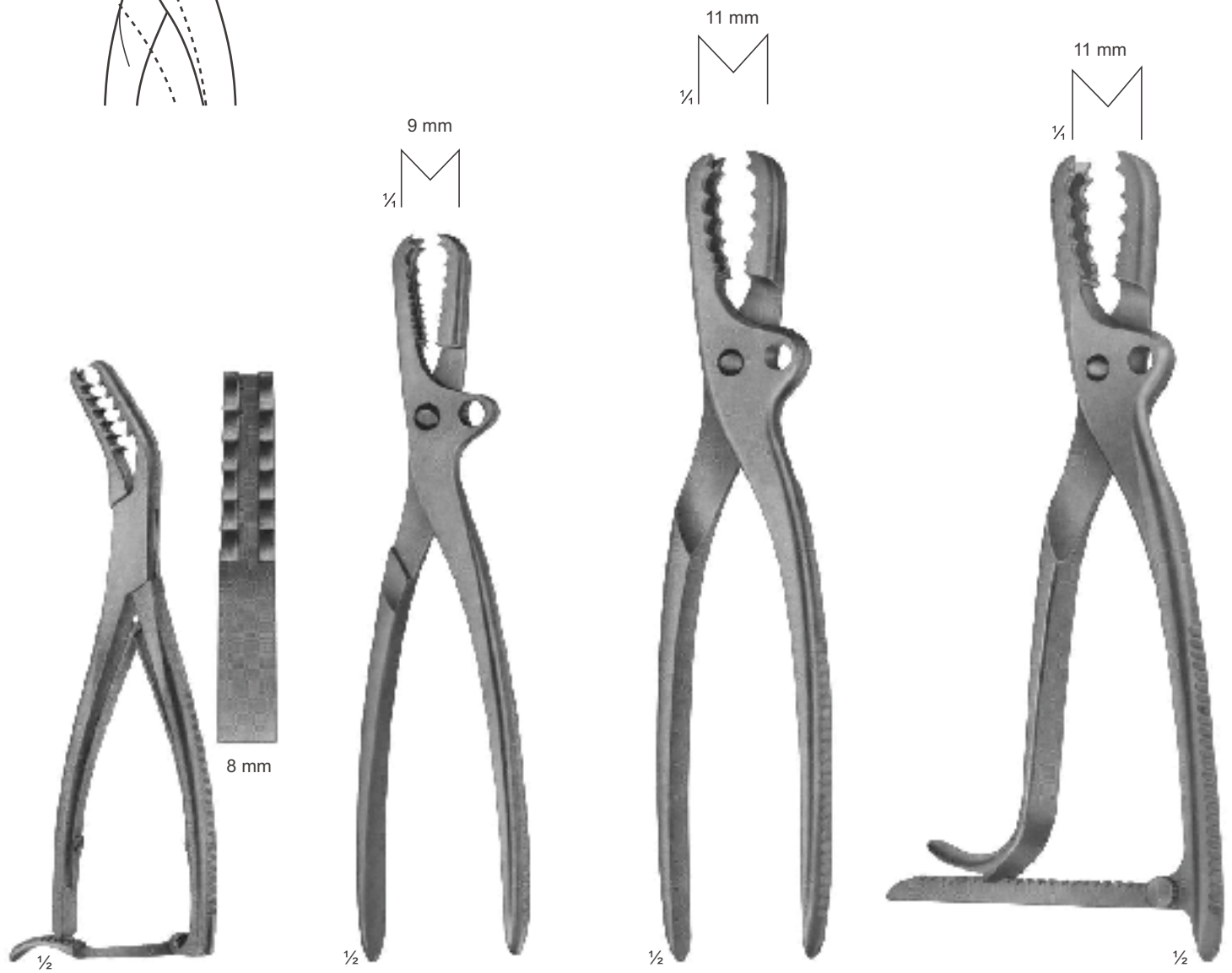
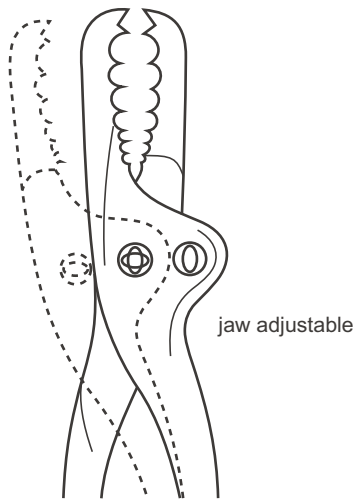

22-115
SEMB
190 mm

22-116
FARABEU
230 mm

22-117
FARABEU
255 mm

22-118
FARABEU-LAMBOTTE
255 mm

Bone Holding Forceps

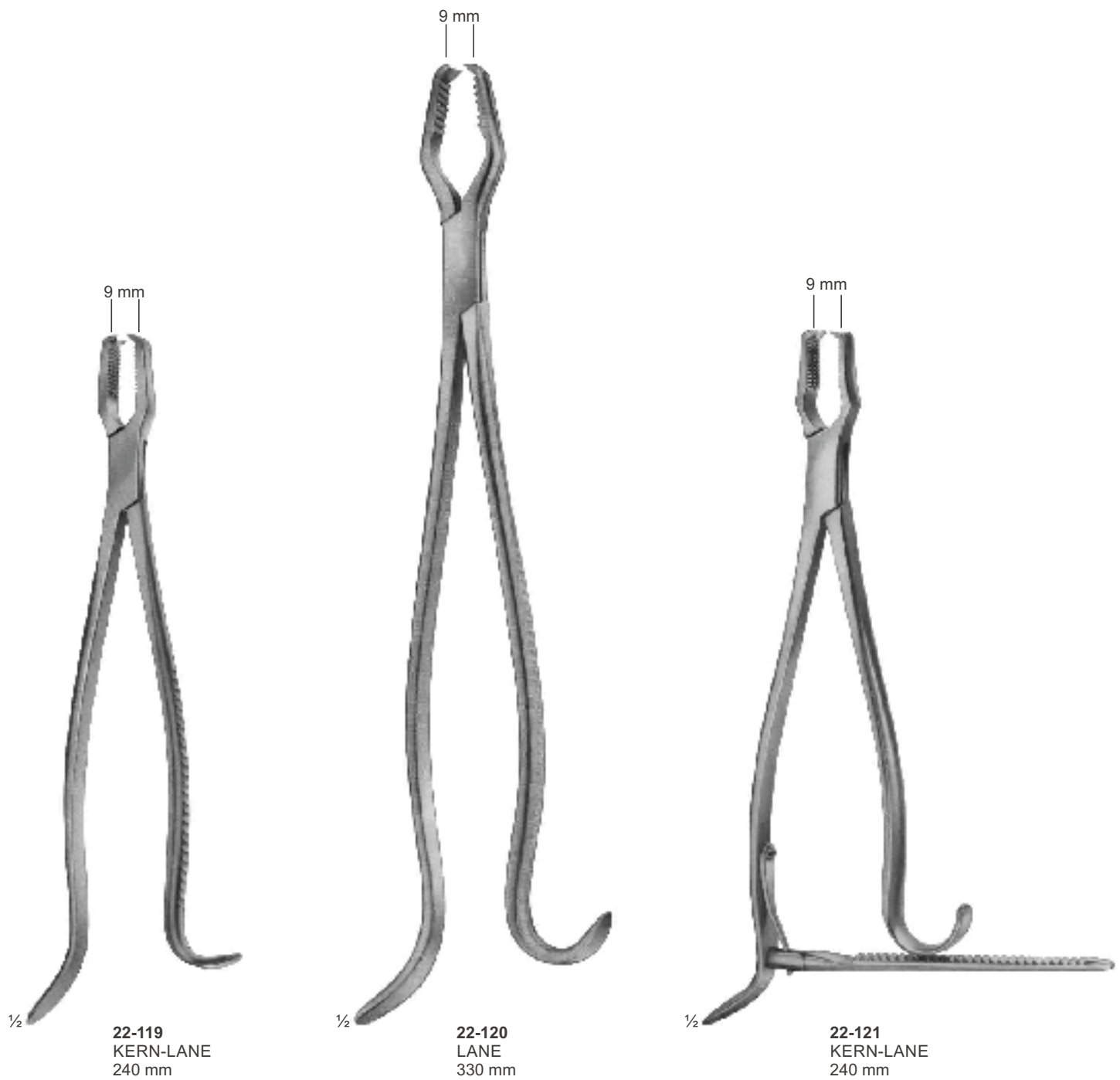

Bone Holding Forceps

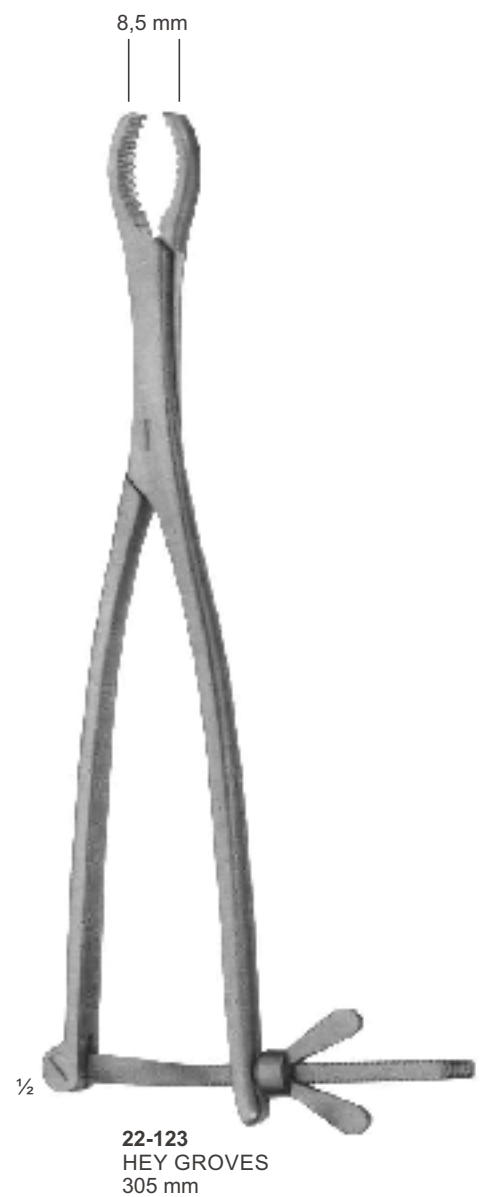

Bone Holding Forceps



22-124 - 128

- 22-124 145 mm
- 22-125 190 mm
- 22-126 240 mm
- 22-127 260 mm
- 22-128 280 mm

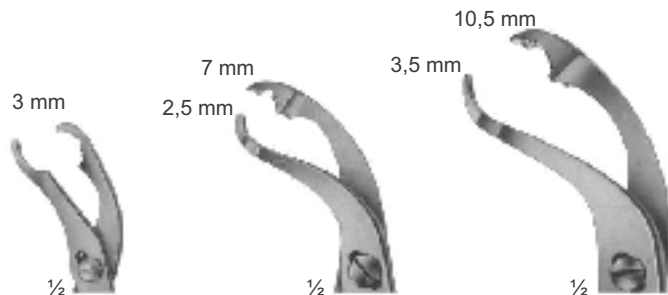

22-124
for small
fragments

22-125
Fig: 0

22-126
Fig: 1

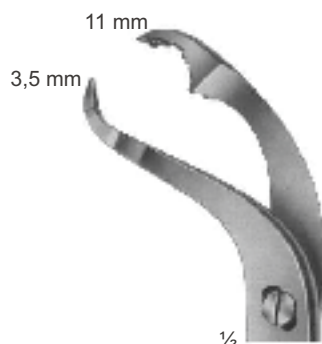

22-127
Fig: 2

22-128
Fig: 3

Self-centering forceps
with thread fixation



22-129 - 131
VERBRUGGE
with lio joint

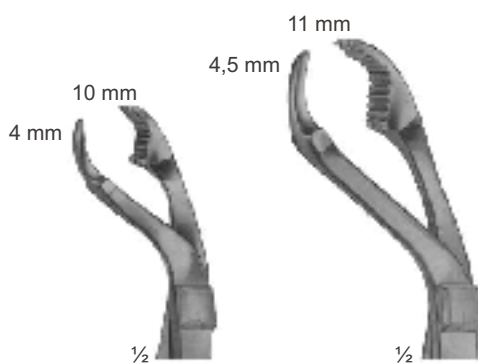

22-129
Fig: 1

22-130
Fig: 2

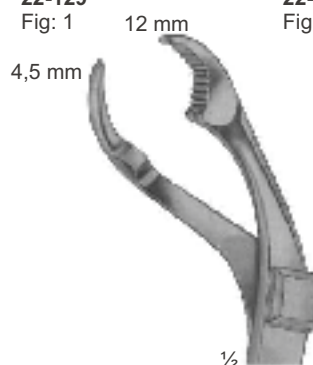

22-131
Fig: 3



22-132
LAMBOTTE
265 mm

Bone Clamps



½

22-133 - 134
LOWMAN
22-133 170 mm
22-134 205 mm



½

22-135
LOWMAN-GERSTER
210 mm



½

22-136
LOWMAN-HOGLUND
175 mm

Synovectomy-Rongeurs, Bone Rongeurs



22-137 - 138
Synovcetomy rongeur
width of jaws 1.2 mm
130 mm

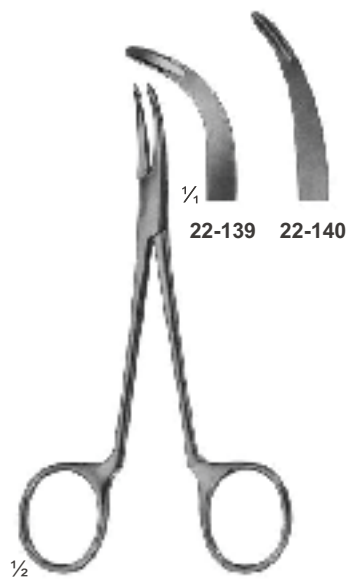

22-139 - 140
Synovcetomy rongeur
width of jaws 2.0 mm
130 mm

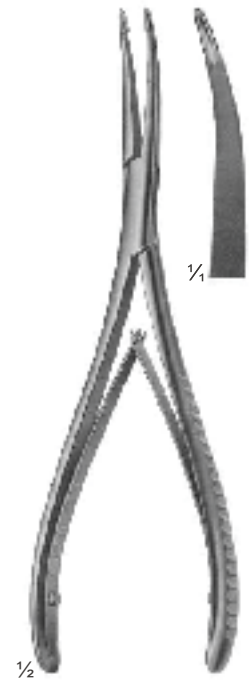

22-141
STELLBRINK
Synovectomy rongeur
175 mm

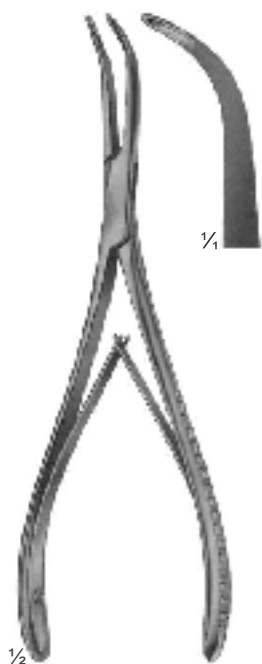

22-142
STELLBRINK
Synovectomy rongeur
170 mm

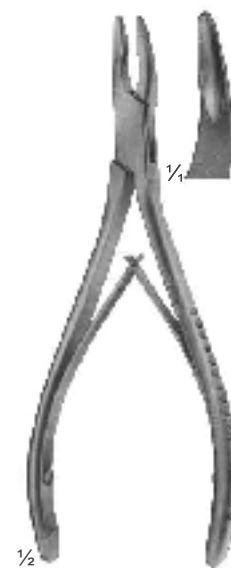

22-143
LURE-FRIEDMANN
145 mm

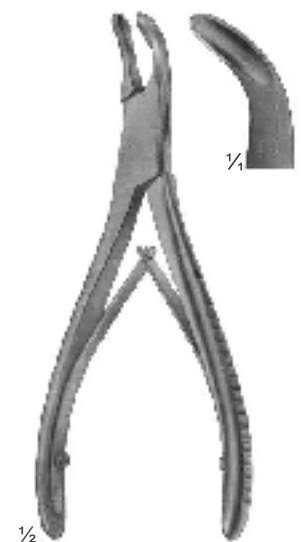

22-144
140 mm

Bone Rongeurs



22-145
LURE
150 mm

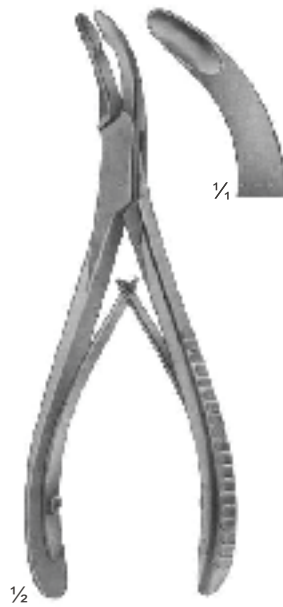

22-146
LURE
155 mm

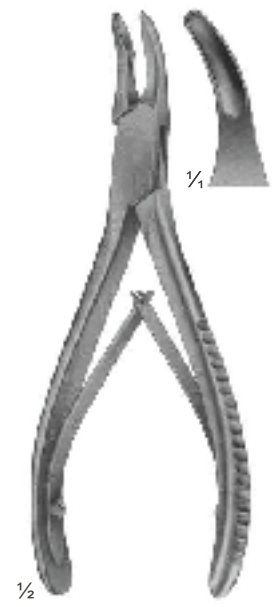

22-147
BLUMENTHAL
155 mm



22-148
BLUMENTHAL
150 mm

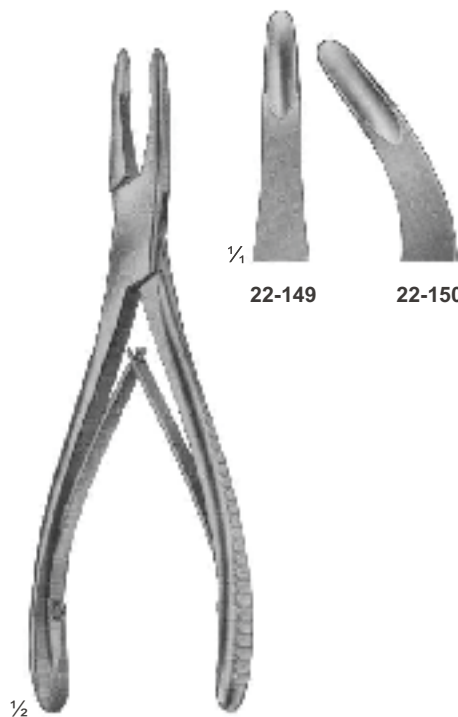

22-149 - 150
JANSEN
175 mm

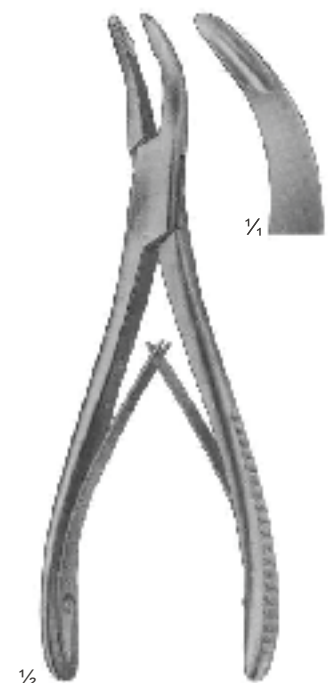

22-151
BANE-HARTMANN
175 mm

Bone Rongeurs

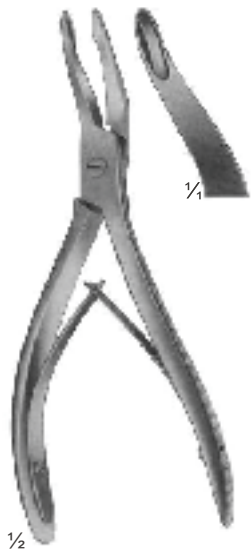

22-152
ALEXANDER
140 mm

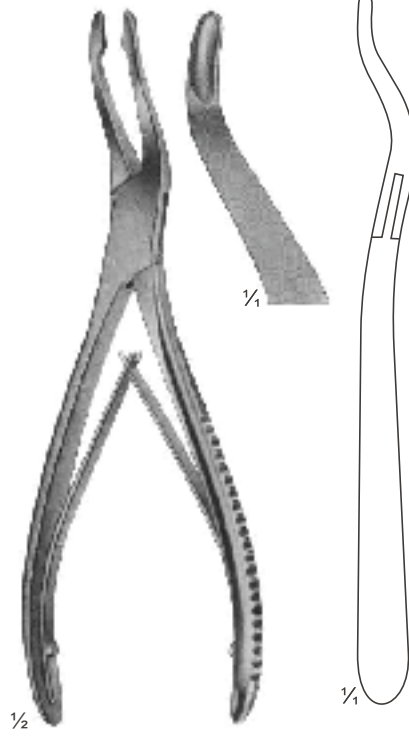

22-153
JANSEN
190 mm

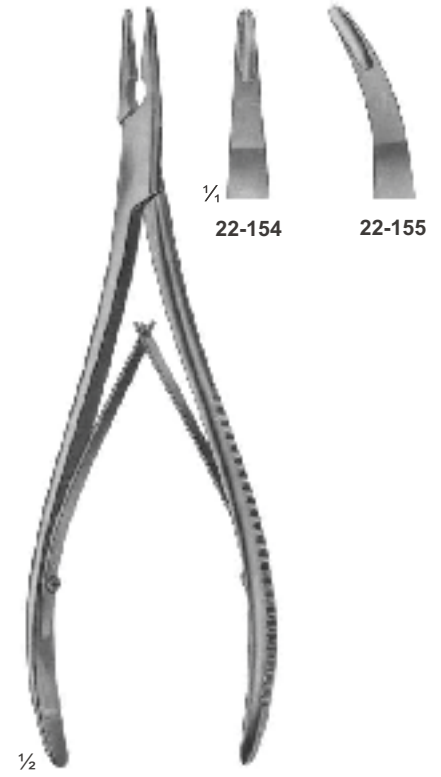

22-154 - 155
LEMPERT
200 mm

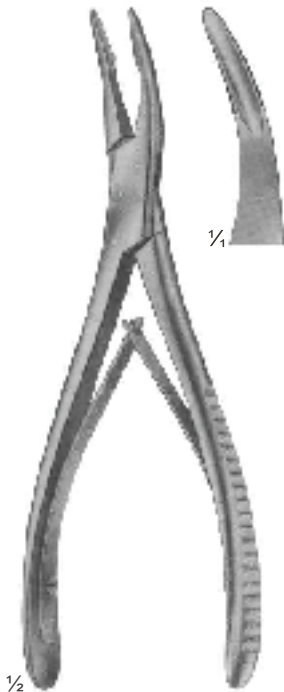

22-156
BEYER
180 mm

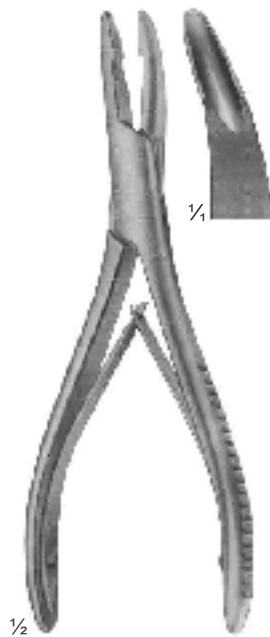

22-157
MEAD
165 mm

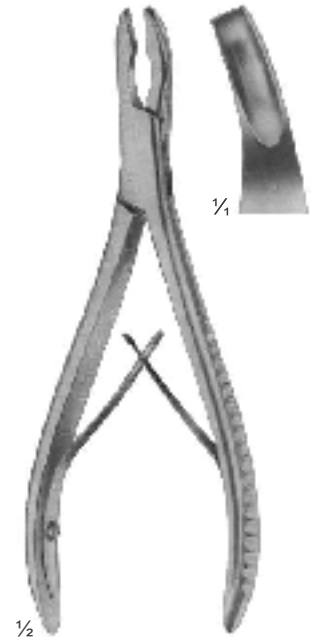

22-158
MEAD
165 mm

Bone Rongeurs

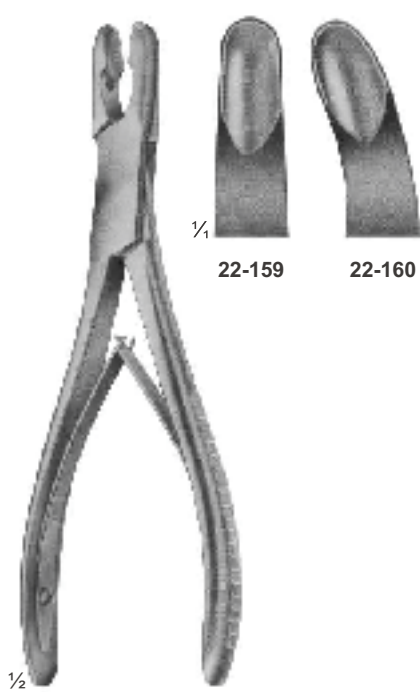

22-159 22-160

22-159 - 160
LURE
175 mm

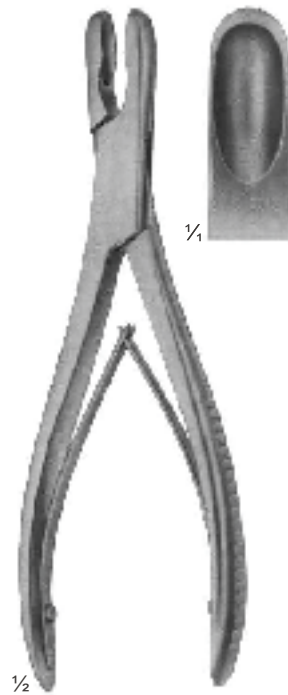

22-161
LURE
180 mm

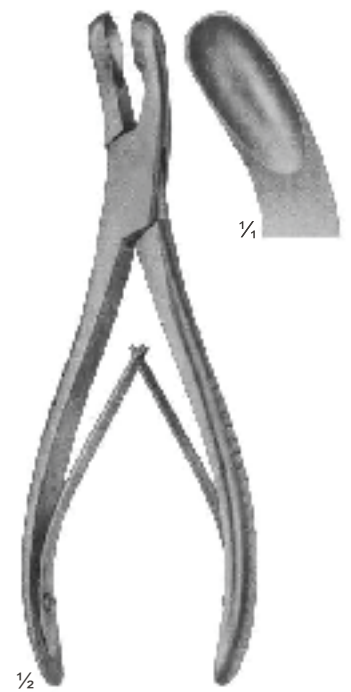

22-162
LURE
180 mm

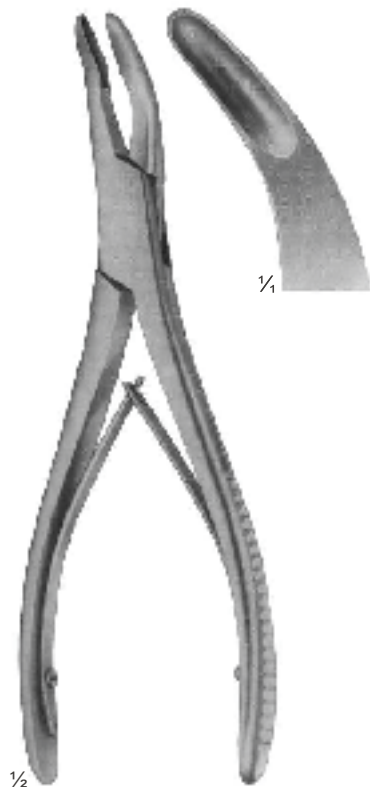

22-163
OLIVECRONA
205 mm



22-164 - 165
BOHLER
155 mm

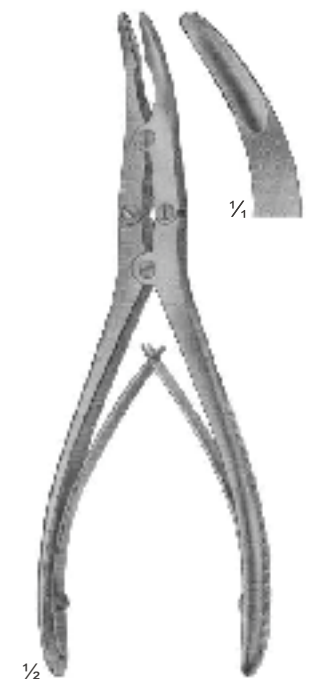

22-166
MARQUARTD
200 mm

Bone Rongeurs

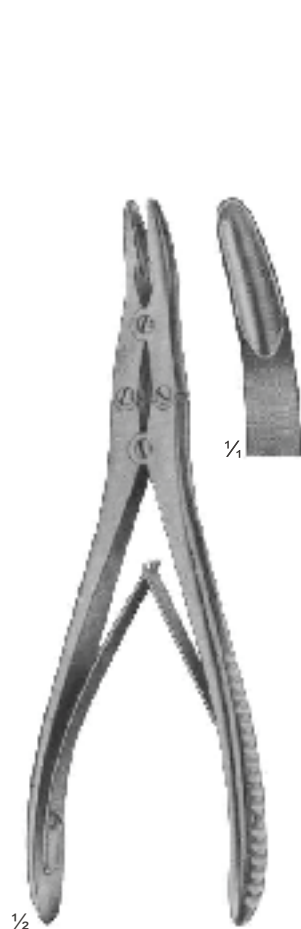

22-167
RUSKIN
190 mm



22-168
ROTTGEN-RUSKIN
240 mm

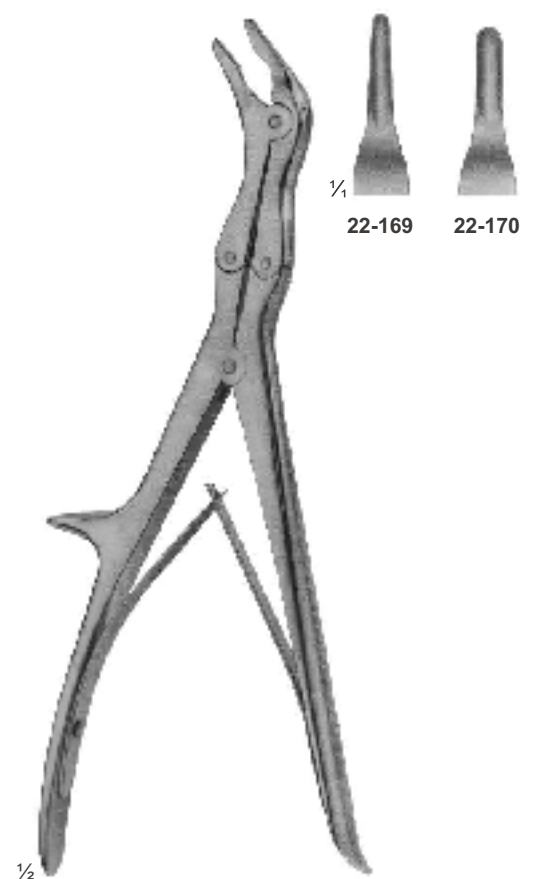

22-169 - 170
ECHLIN
230 mm

Bone Rongeurs

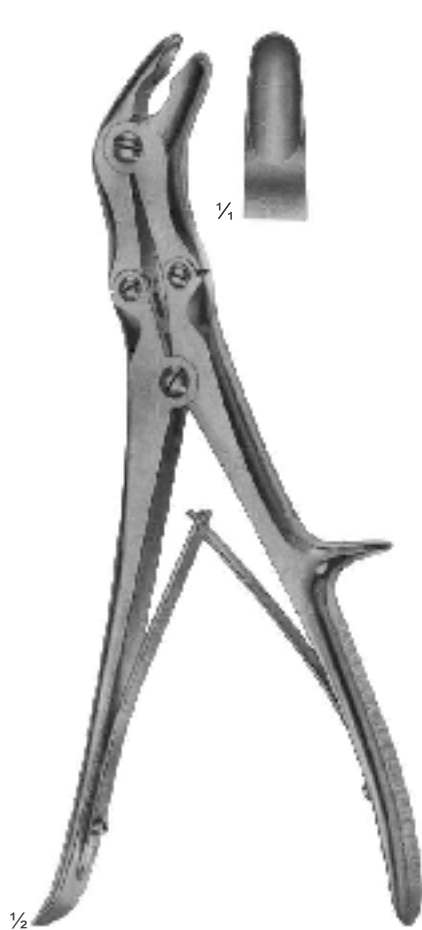

22-171
STILLE
235 mm



22-172
LEKSELL-STILLE
240mm



22-173
STILLE-RUSKIN
240mm

Bone Rongeurs



22-174
LURE-STILLE
225 mm



22-175
LURE-STILLE
225 mm

Vena-Cava Clamps



17-233 - 235
DE BAKEY
205 mm, 225 mm, 240 mm



$\frac{1}{4}$
17-233 41 mm
17-234 65 mm
17-235 80 mm



17-236 - 238
DE BAKEY
200 mm, 225 mm, 240 mm



$\frac{1}{4}$
17-236 41 mm
17-237 65 mm
17-238 80 mm

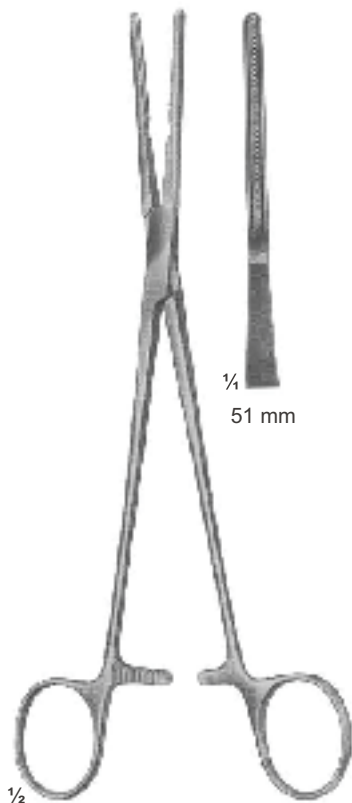

17-239
DE BAKEY
210 mm



$\frac{1}{4}$
51 mm



17-240
DE BAKEY
210 mm

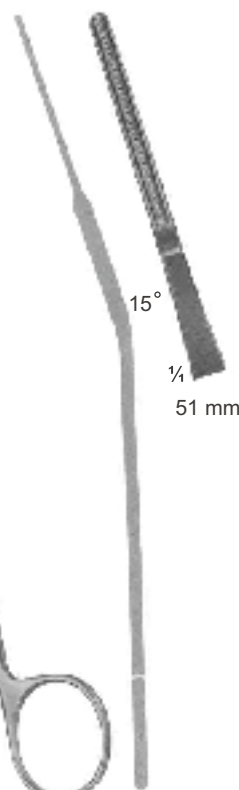

15°
 $\frac{1}{4}$
51 mm



17-241
DE BAKEY
160 mm



$\frac{1}{4}$
56 mm

Bone Cutting Forceps

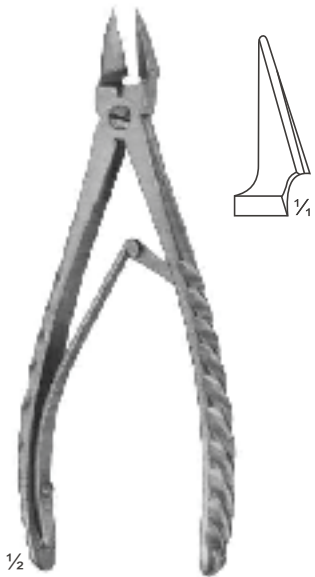

22-178
STAMM
150 mm

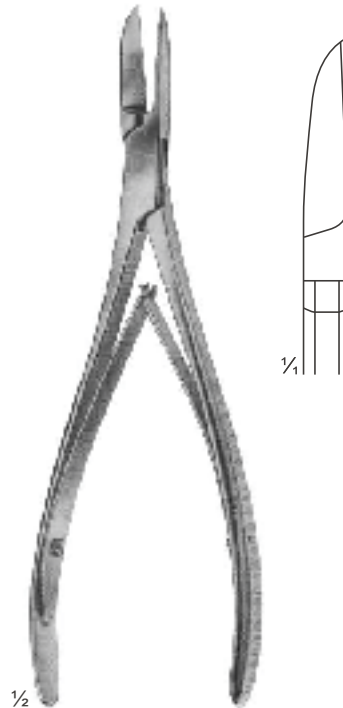

22-179
KAZANJIAN
185 mm

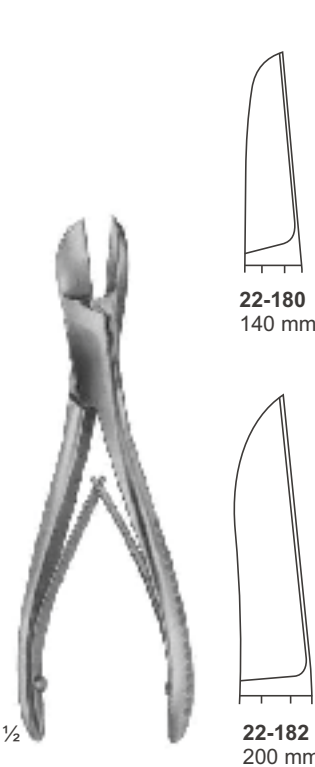

22-180 - 183
LISTON

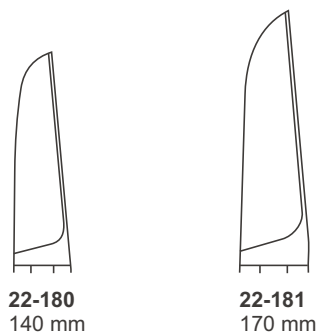

22-180
140 mm

22-181
170 mm

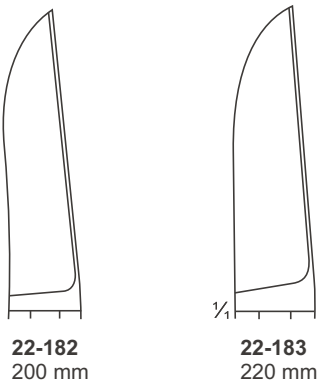

22-182
200 mm

22-183
220 mm

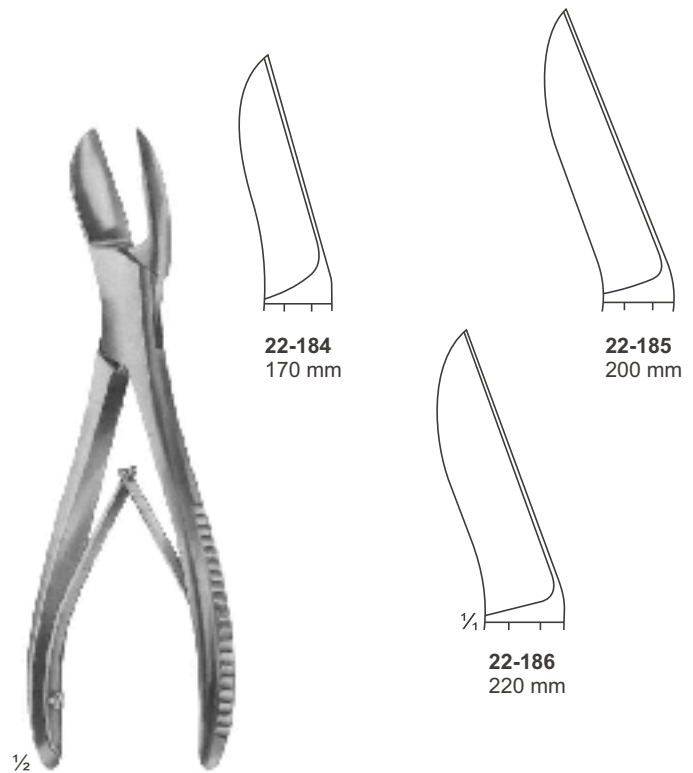

22-184 - 186
LISTON

22-184
170 mm

22-185
200 mm

22-186
220 mm

Bone Cutting Forceps

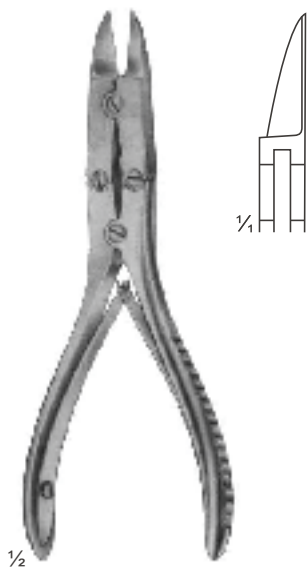

22-187
BOHLER
145 mm

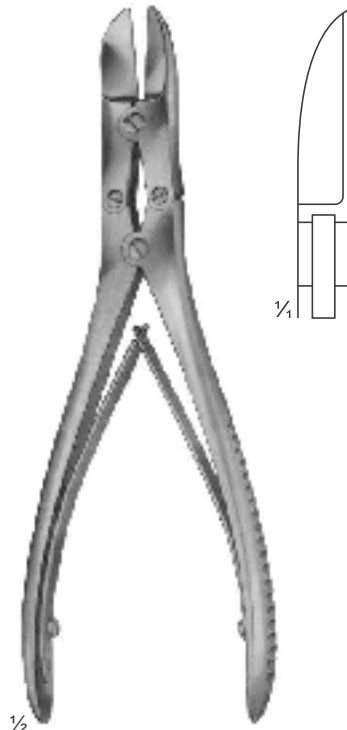

22-188
RUSKIN-LISTON
190 mm

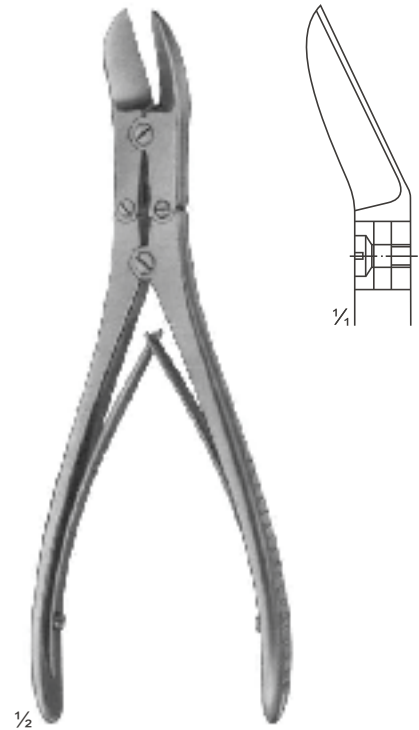

22-189
RUSKIN-LISTON
190 mm

Bone Cutting Forceps

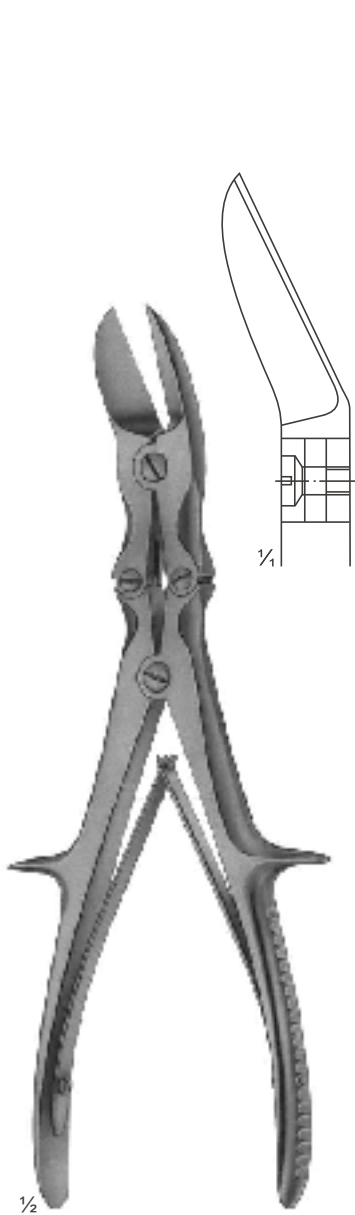

22-190
LISTON
curved on flat
240 mm

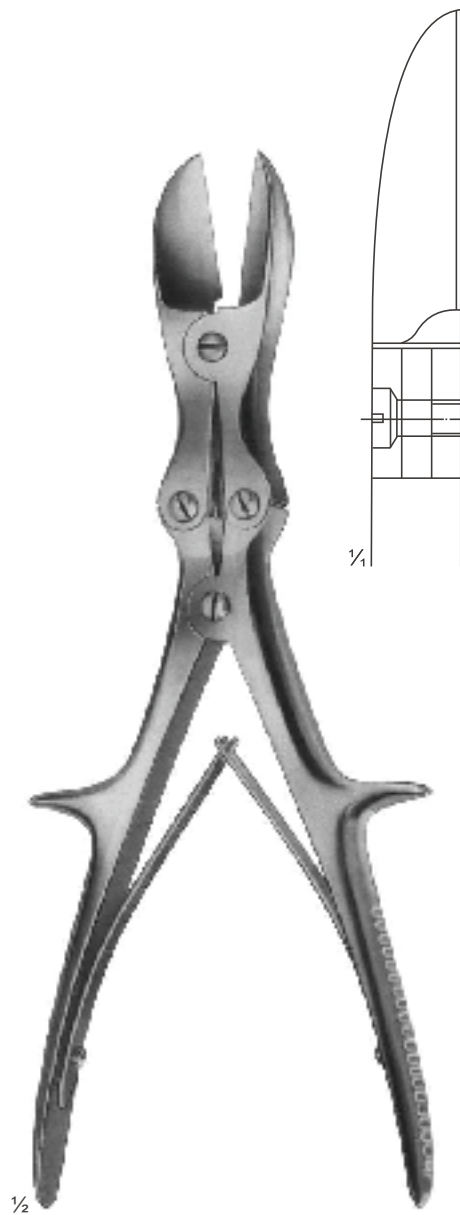

22-191
LISTON
straight
280 mm

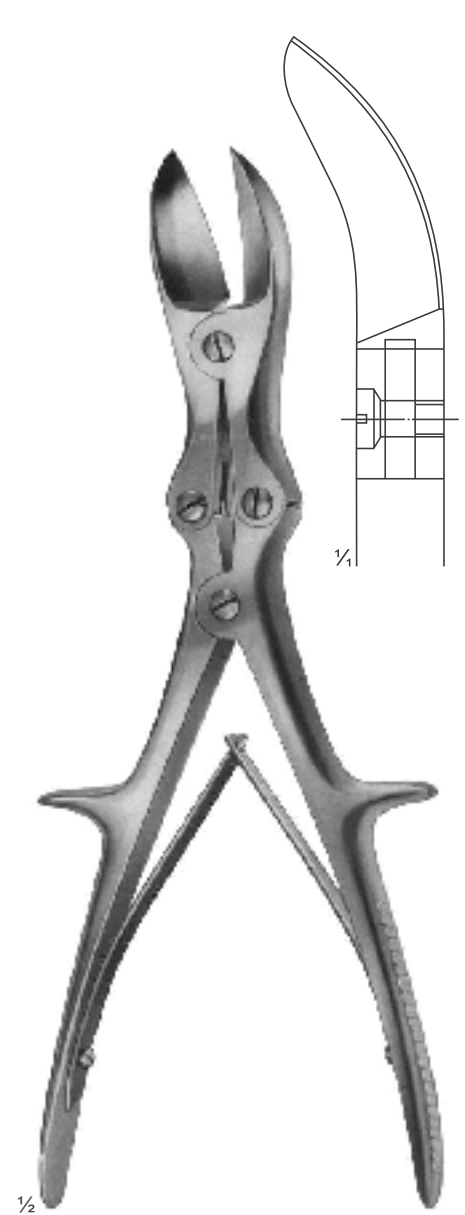

22-192
LISTON
curved on flat
280 mm

Bone Cutting Forceps

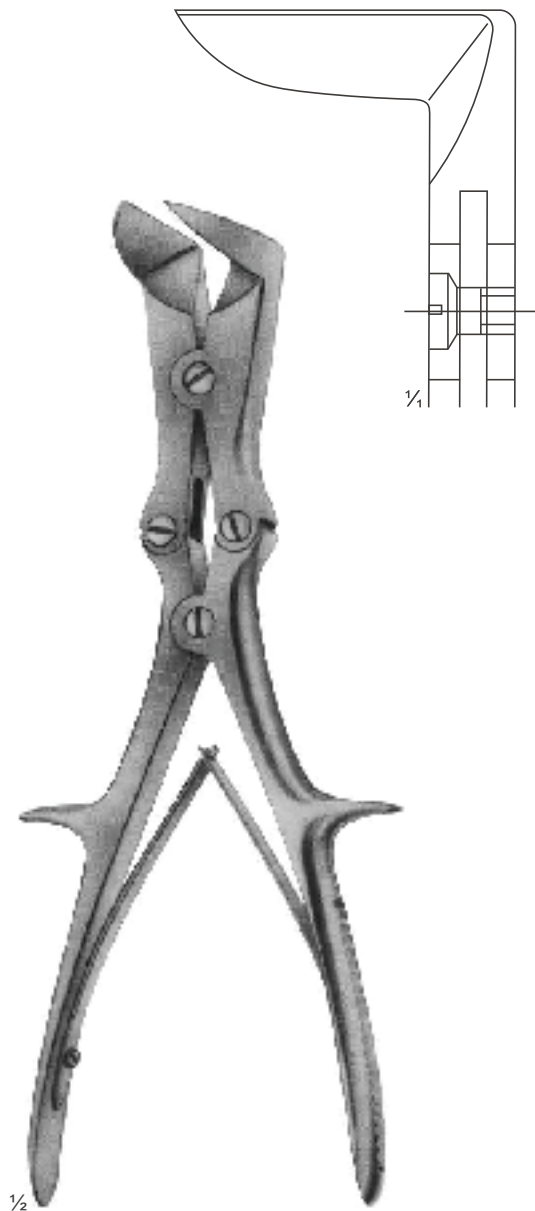

22-193
LISTON-STILLE
265 mm

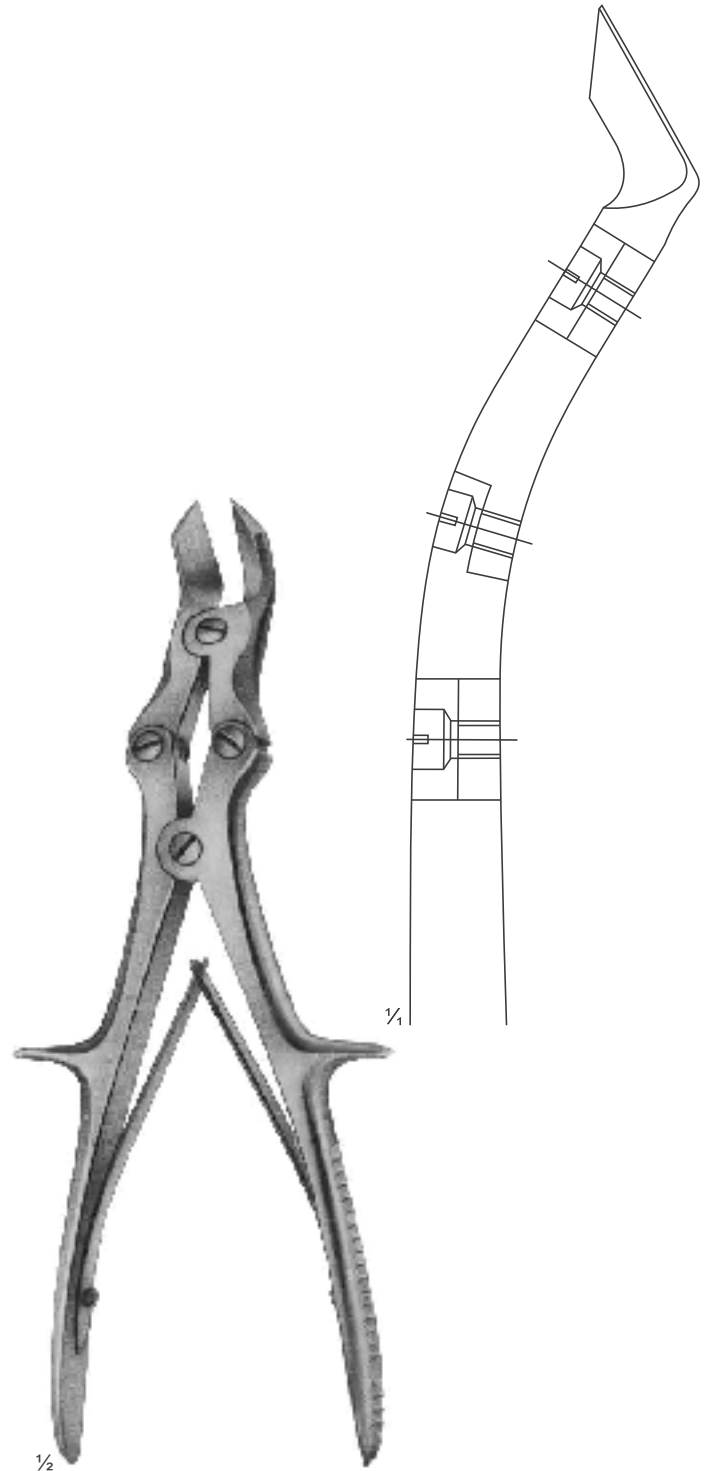

22-194
LISTON-KEY-HORSLEY
(TUDOR EDWARDS)
255 mm

Meniscus-and Cartilage Forceps



22-195
BIRCHER
200 mm

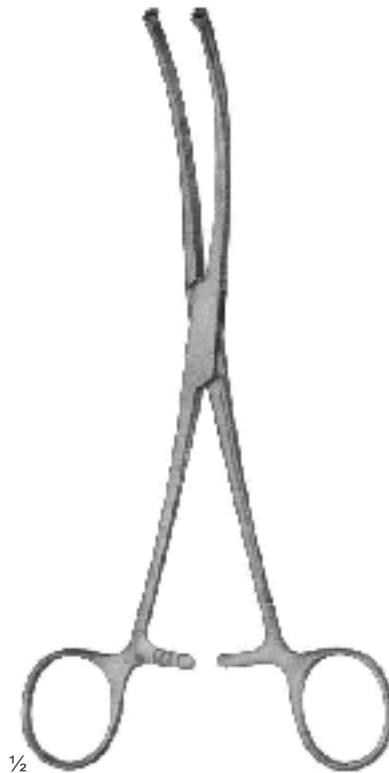

22-196
BIRCHER
200 mm

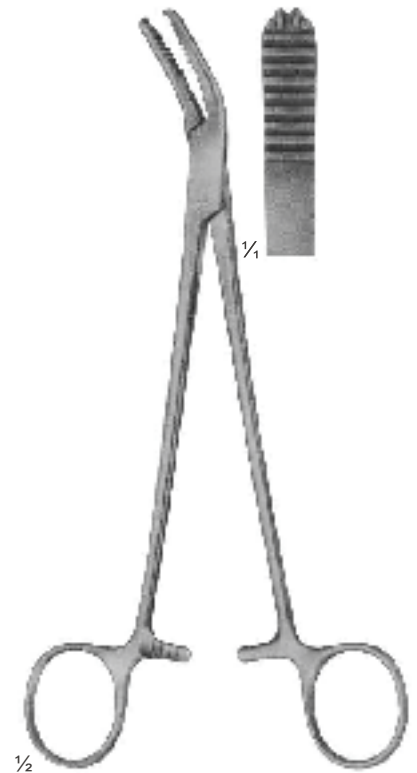

22-197
WELLER
200 mm

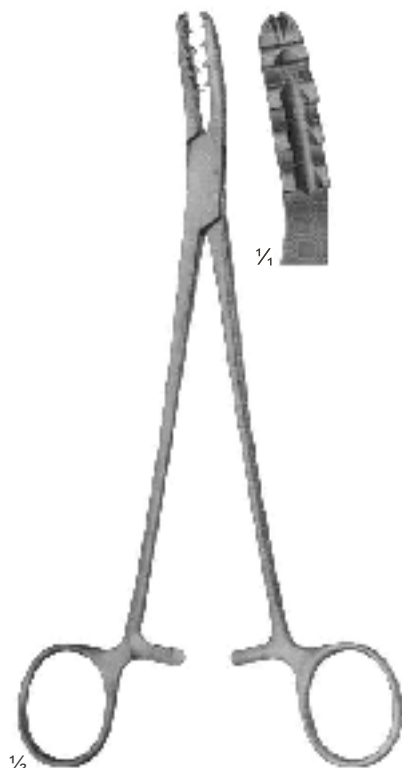

22-198
BIRCHER-GANSKE
200 mm

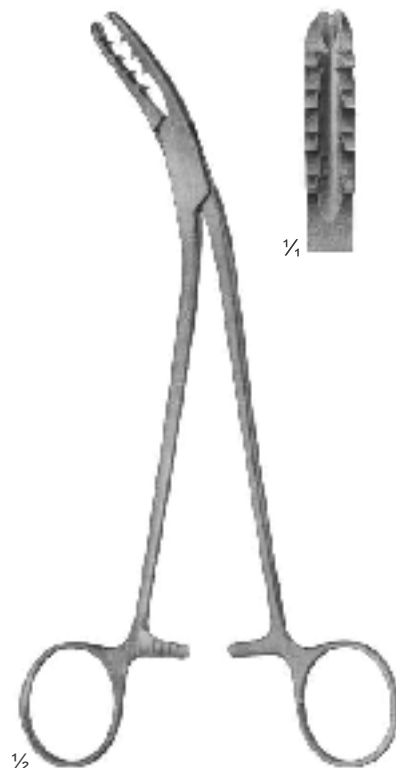

22-199
BIRCHER-GANSKE
200 mm



22-200
MARTIN
205 mm

Meniscus Knives

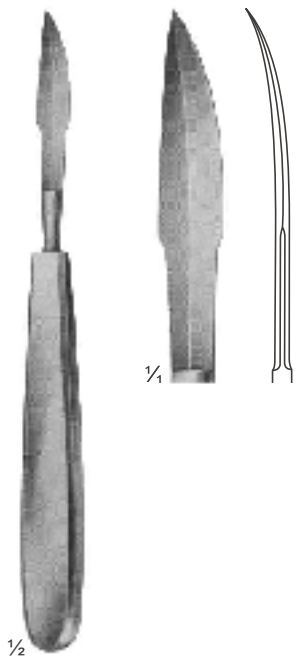

22-201
170 mm

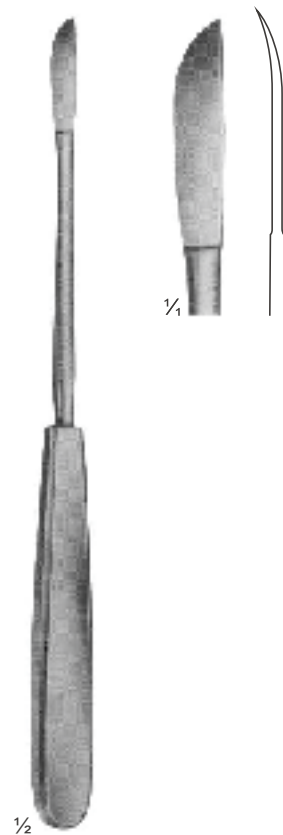

22-202
NEFF
215 mm



22-203
NEFF
215 mm

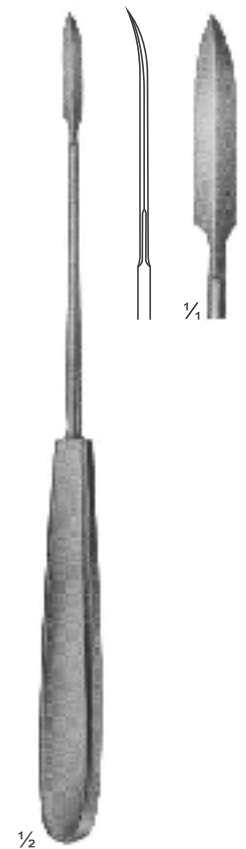

22-204
WAGNER
215 mm

Meniscus Knives

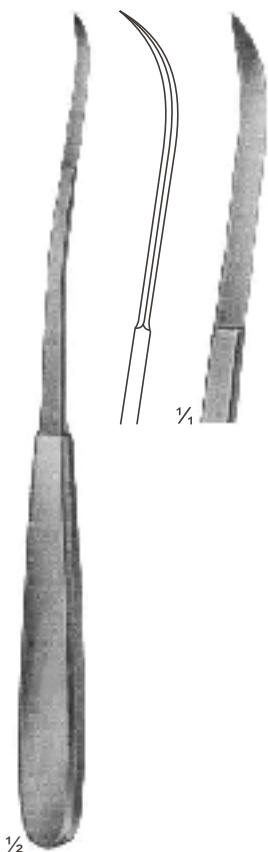

22-205
SALENIUS
220 mm

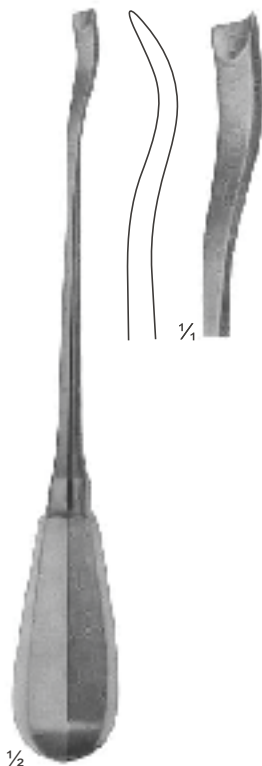

22-206
CHNAD.MODELL
200 mm

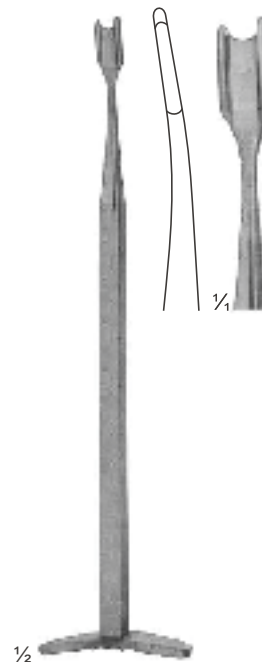

22-207
SMILLIE
170 mm

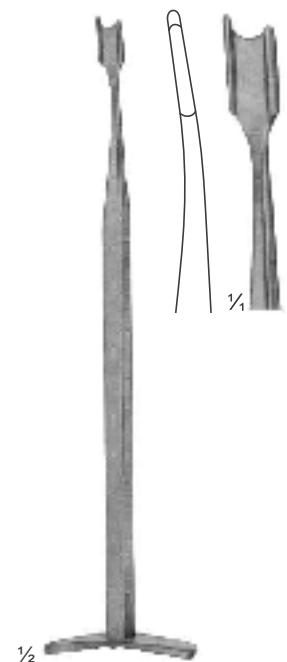

22-208
SMILLIE
170 mm

Wire Extension

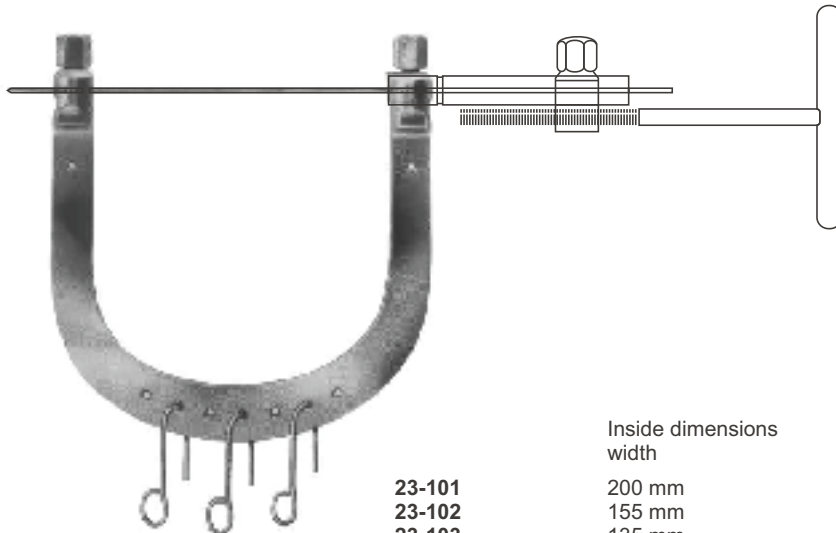

23-101 - 107
KIRSCHNER
Wire traction bows,
to be used with
KIRSCHNER-wires
up to 2.5 mm diam.,
With 3 hooks,
stainless steel

23-101
23-102
23-103
23-104
23-105
23-106
23-107

Inside dimensions
width

200 mm
155 mm
135 mm
120 mm
105 mm
95 mm
95 mm

depth

155 mm
155 mm
130 mm
120 mm
100 mm
110 mm
70 mm



23-108
Wrench, double - ended,
for wire traction bows

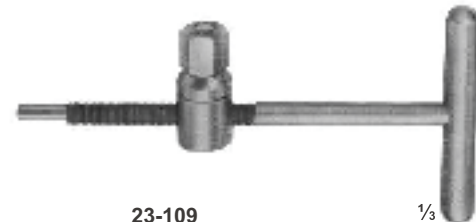

23-109
Wire tightener, with
clamping jaws

1/3



1/3

23-110
Traction hook only,
large size



1/3

23-111
Traction hook only,
small size



1/3

23-112
Fixation clamp, to secure clamping
jaws of stainless steel

Wire Extension

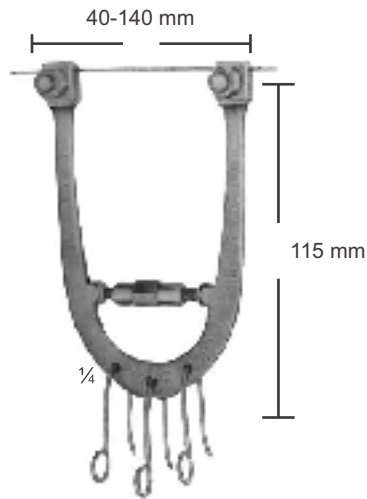

23-113
Wire traction bow, adjustable,
with 3 hooks, small size

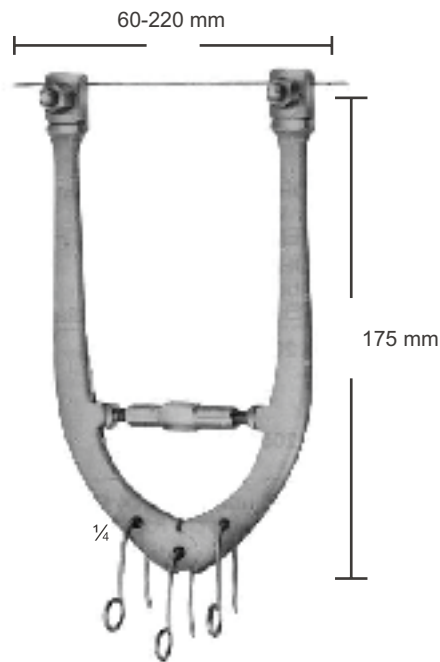

23-114
Wire traction bow, adjustable,
with 3 hooks, large size

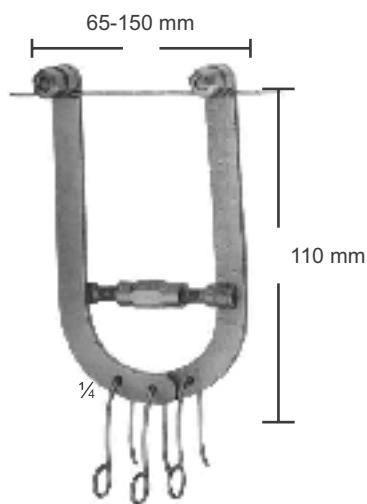

23-115
Wire traction bow, adjustable,
with 3 hooks, large size for
elbow and calcaneus, for
adolescents

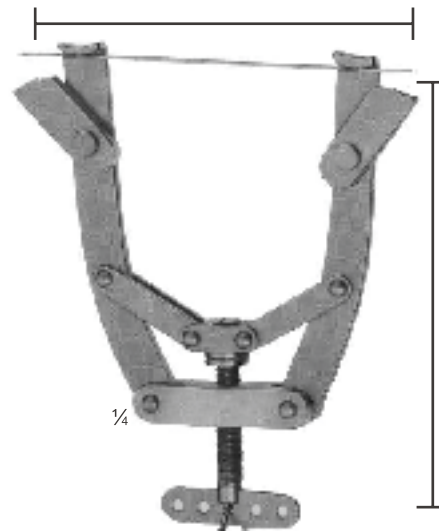

23-116 105 mm
23-117 160 mm
23-118 200 mm

23-116 1,6 mm
23-117 2,0 mm
23-118 2,5 mm

23-116 - 118
KIRSCHNER
Wire traction bow, modified
adjustable in with width, holds wire
securely, with 1 hook

23-119 ½
Fixation disc, slotted

23-121 ½
Fixation disc, slotted

23-120 ½
idem, aluminum, transparent
to X-rays



23-122
Screw driver, for above
fixations discs

Traction Bows, Distractor



23-123 - 130
Screw driver, for above
fixations discs

| Steinmann pins, 4 mm daim. | | Steinmann pins, 5 mm daim. | |
|----------------------------|-------------|----------------------------|-------------|
| 23-123 | with pin | | 16x9cm Arm |
| 23-124 | without pin | 23-129 | without |
| 23-125 | with pin | | 21x11cm Arm |
| 23-126 | without pin | 23-130 | without |
| 23-127 | with pin | | 21x15cm Arm |
| 23-128 | without pin | | |



23-131
SCHWARZ
Traction bow for fingers,
to be used with KIRSCHNER-
wire up to 1.6 mm diam.

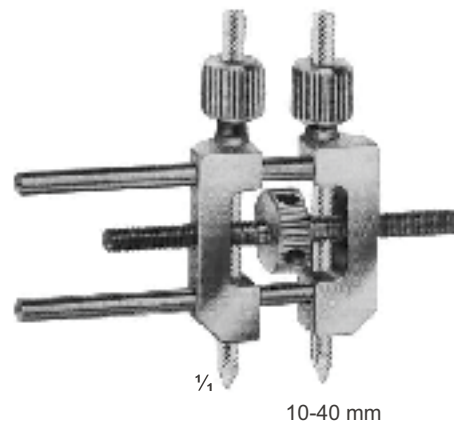

23-132
Small distractor
as a repositioning device for
distraction and compression of small bones,
for wires with 3.0 mm diam.

STEINMANN Pins



23-133 - 147
STEINMANN
triangular shaft ended and trocar point

| Length | 4,0 mm | 5,0 mm |
|--------|---------------|---------------|
| 80 mm | 23-133 | |
| 100 mm | 23-134 | |
| 120 mm | 23-135 | |
| 140 mm | 23-136 | |
| 150 mm | 23-137 | 23-143 |
| 160 mm | 23-138 | |
| 180 mm | 23-139 | 23-144 |
| 200 mm | 23-140 | 23-145 |
| 210 mm | 23-141 | |
| 250 mm | 23-142 | 23-146 |
| 300 mm | | 23-147 |



1/4

23-148
Protection cap
for 4,0 mm STEINMANN Pins



1/4

23-149
Protection cap
for 5,0 mm STEINMANN Pins

Drilling Chucks



1/2

23-150
REILL
Drilling chuck,
cannulated,
for shanks from
2.0 - 2.5 mm diam
115 mm



1/2

23-151
Drilling chuck,
cannulated,
for shanks from
0.8 - 2.0 mm diam
150 mm



1/2

23-152
Drilling chuck,
cannulated,
for shanks up to
4.5 mm diam
with key
140 mm



1/2

23-153
LOUTE
Wire tightener, improved pattern,
with movable tip,
for wires up to 1.0 mm diam.
220 mm

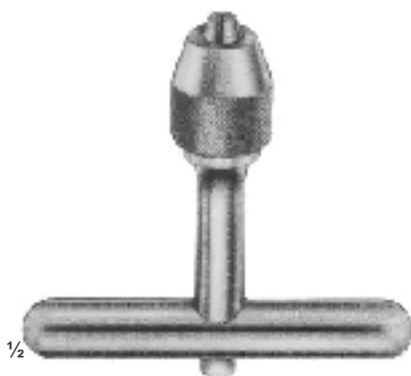

1/2

23-154
Drilling chuck, cannulated,
for shanks up to 6.35 mm diam.,
To be tightened by hand
100 mm

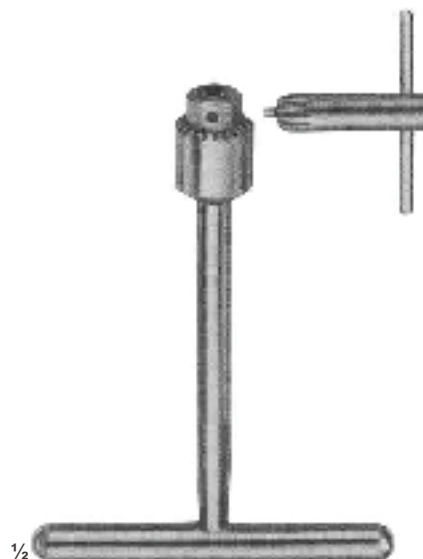

1/2

23-155
Drilling chuck, cannulated,
for shanks up to 4.5 mm diam.,
And for triangular shaft width
across flats 4.7 mm



1/2

23-156
Drilling chuck, cannulated,
for shanks up to 6.35 mm diam.,
With key
160 mm

Cerclage Instruments

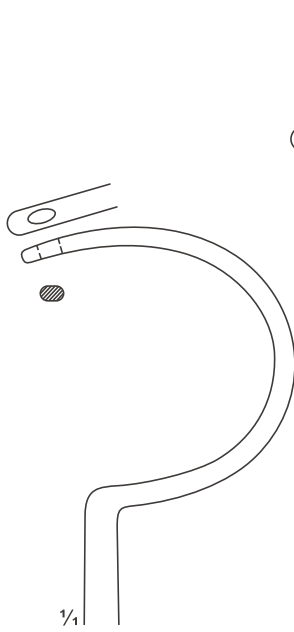

23-157
275 mm

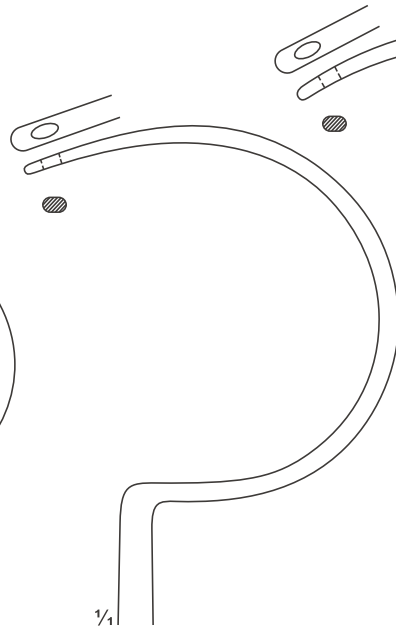

23-158
285 mm

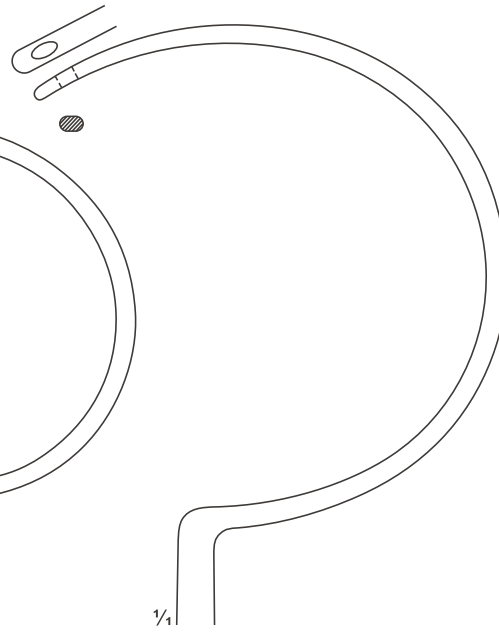

23-159
305 mm



23-157 - 159
DEMEL
Wire guides

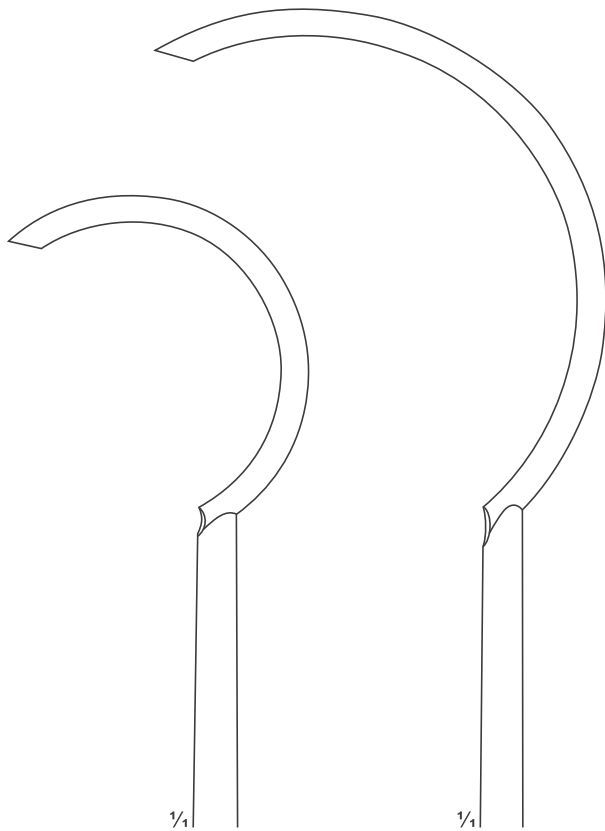

23-160
240 mm



23-161
270 mm

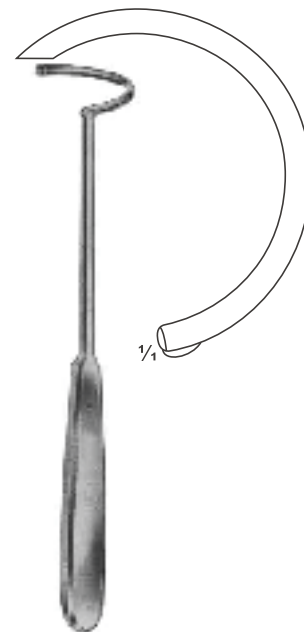

23-162
225 mm

JORDAN instruments for subcutaneous Tibia Cerclage



23-163
JORDAN
Wire tightener



1/2

23-164
JORDAN
Wire twister
170 mm



1/2

23-165
JORDAN
Wire catcher
180 mm



1/2

23-166
JORDAN
Probe, cannulated
170 mm

Wire Holding forceps, Wire Tightening Pliers, Flat-nosed Pliers



23-167
DUROGRIP
Holding forceps for cerclage
wire, with lateral jaws to avoid
wire slipping off
170 mm



23-168
DUROGRIP
Wire, tightening pliers,
Ligature pliers
150 mm



23-169
DUROGRIP
Wire, tightening pliers,
Ligature pliers
150 mm

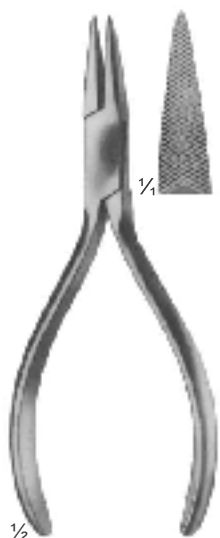

23-170
with serrated jaws
140 mm

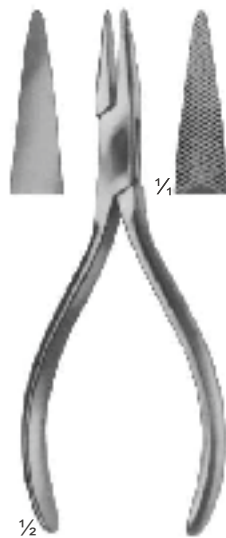

23-171
one jaws smooth,
one jaws serrated
140 mm



23-172
with serrated jaws
23-173
with longitudinal and
transversal grooves
170 mm



23-174
190 mm

Wire Holding forceps, Flat-nosed Pliers, for bending and cutting wires

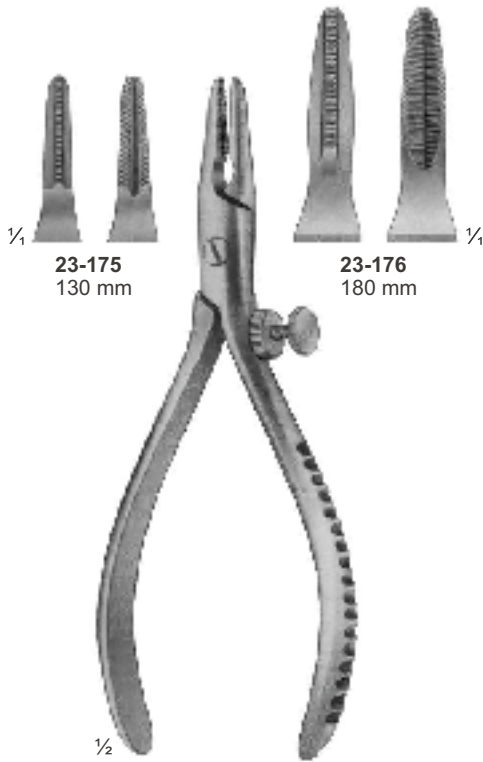

23-175
130 mm

23-176
180 mm

23-175 - 176
Extraction pliers
for boring wires

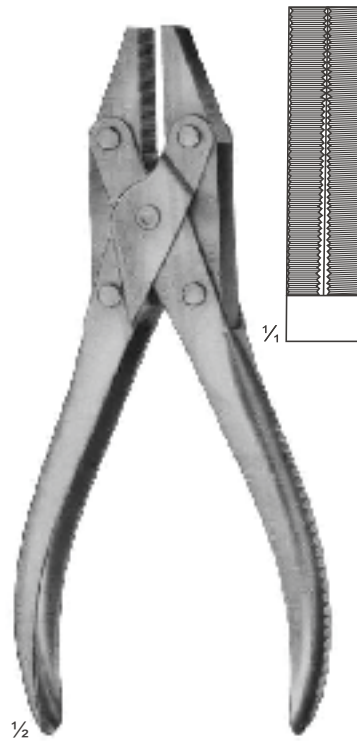

23-177
Flat-nosed pliers,
parallel
185 mm

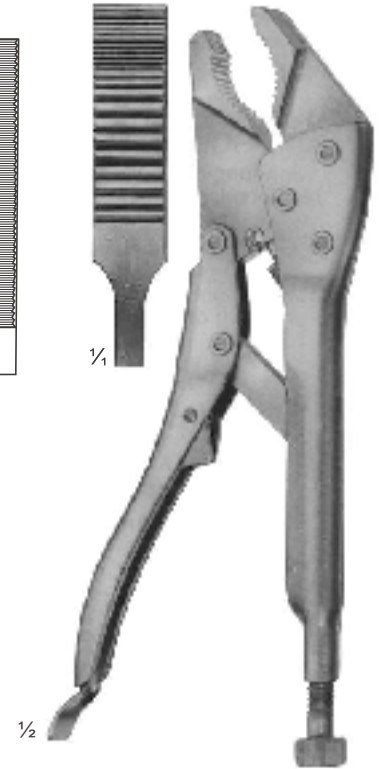

23-178
Vise grip
200 mm

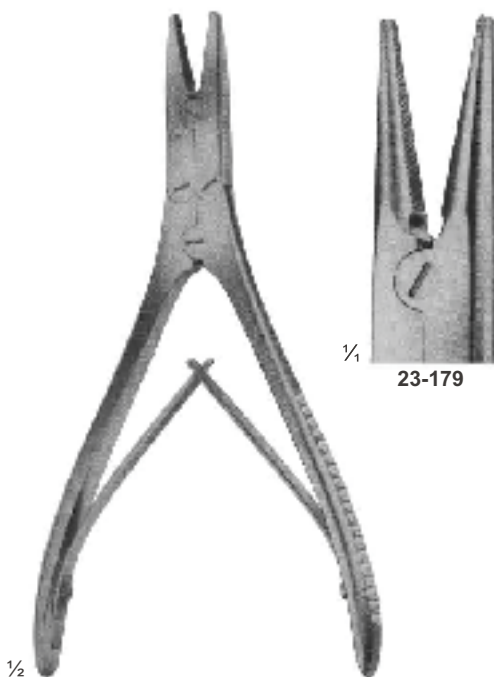

23-179 - 183
Round pliers
180 mm

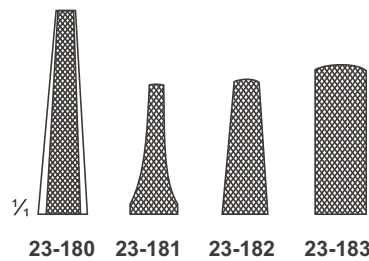

23-180
23-181 145 mm
23-182 180 mm
23-183 180 mm
Extraction pliers for wires

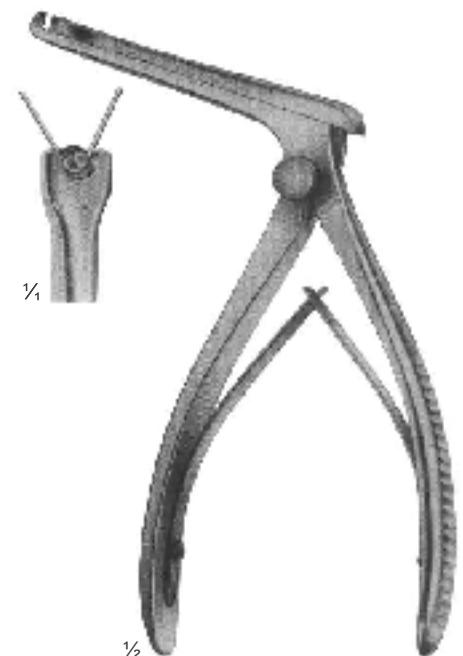

23-184
Bending pliers
for wires up to
1.8 mm diam.

Wire Cutters and wire Cutting Scissors

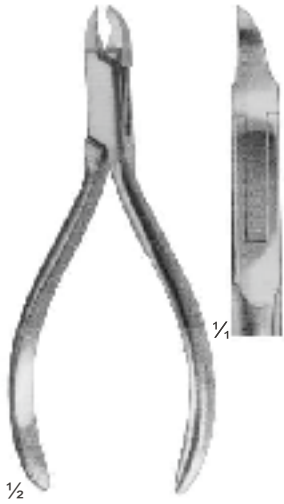

23-185
ANGLE
130 mm

for soft wire
up to diam.
for hard wire
up to diam.



23-186
DUROTIP
ANGLE
130 mm

0,5 mm 0,6 mm
0,3 mm 0,4 mm

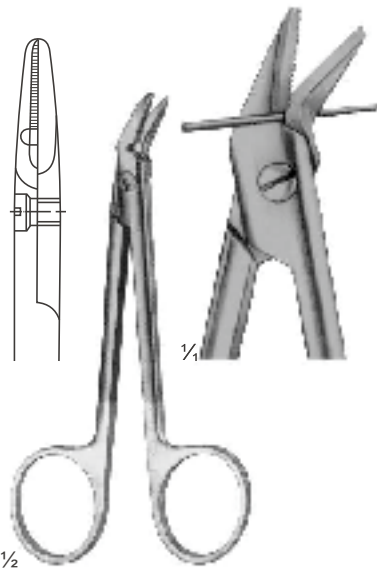

23-187
120 mm

for soft wire
up to diam.
for hard wire
up to diam.

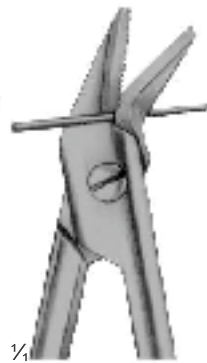

23-188
DUROTIP
120 mm

1,2 mm 1,2 mm
0,8 mm 0,8 mm

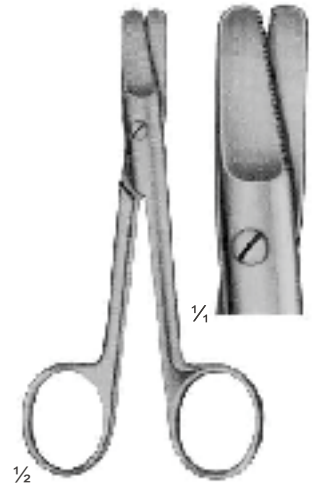

23-189
HARVEY
125 mm

0,4 mm
0,3 mm

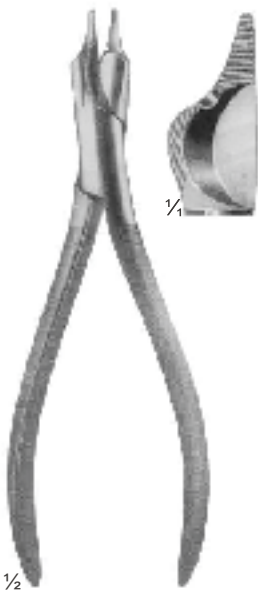

23-190
150 mm

for soft wire
up to diam
for hard wire
up to diam



1,5 mm
1,0 mm



23-191
160 mm

1,5 mm
1,2 mm



23-192
140 mm

1,5 mm
1,0 mm



Wire Cutting Pliers, Lateral Cutting Action

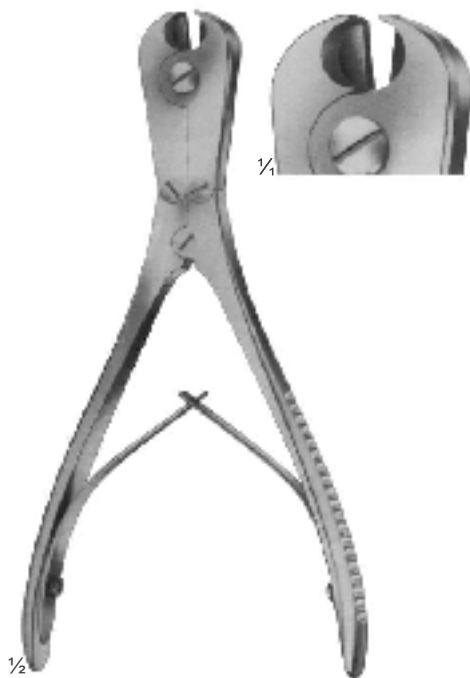

23-193
180 mm

for soft wire
up to diam. 2,0 mm
For hard wire 1,5 mm
up to diam
specially hardened
cutting edges, front
and lateral cutting
action



23-194
REILL
175 mm

for soft wire
up to diam. 2,0 mm
For hard wire 1,6 mm
up to diam
specially hardened
cutting edges, for
cutting off wires close
to the bone



23-195
235 mm

for soft wire
up to diam. 3,0 mm
For hard wire 2,2 mm
up to diam

Wire Cutting Pliers, Lateral and Front Cutting Action

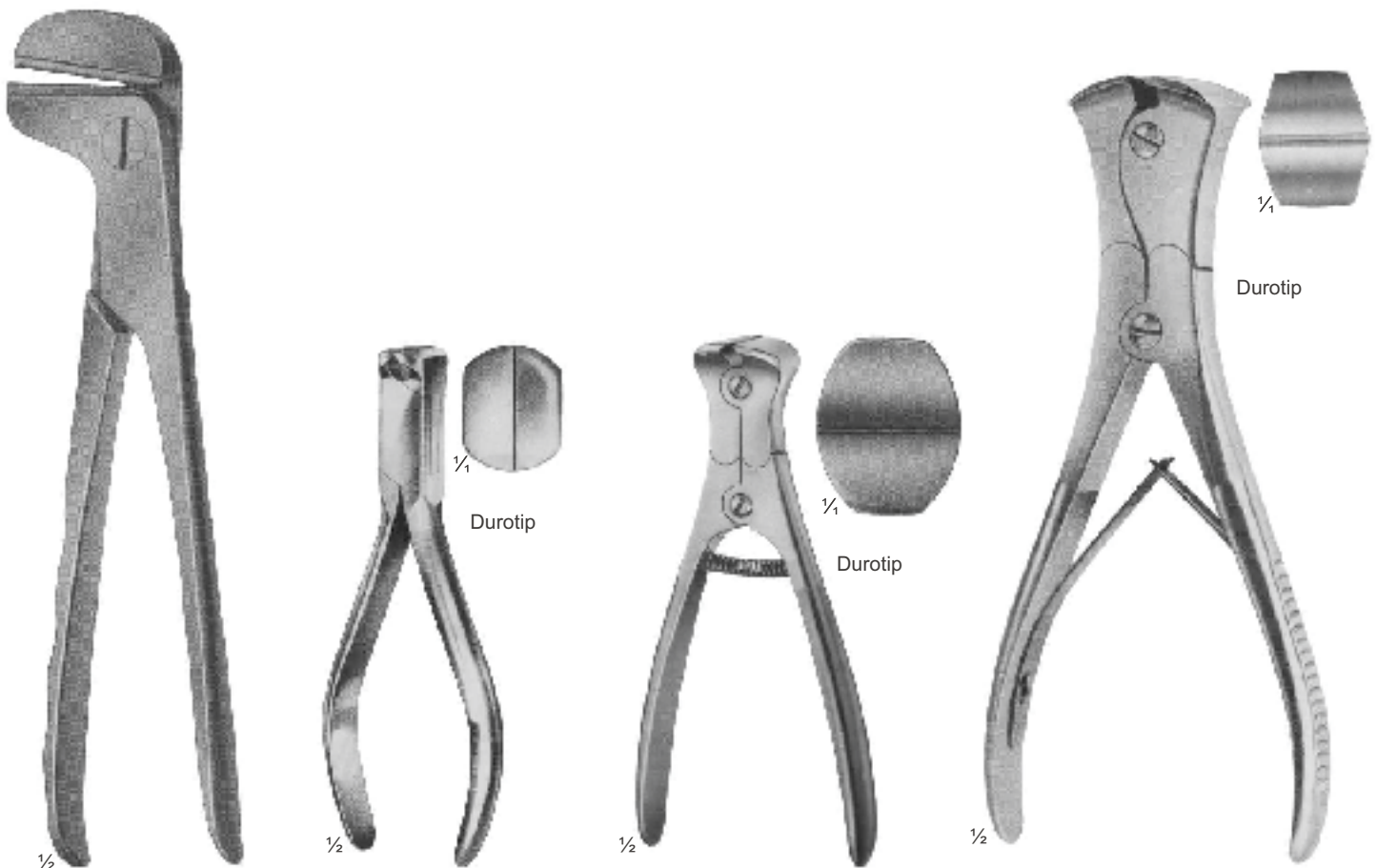

1/2
23-196
240 mm

for soft wire
up to diam. 2,0 mm
For hard wire
up to diam. 1,6 mm

1/2
23-197
140 mm

for soft wire
up to diam. 1,5 mm
For hard wire
up to diam. 1,0 mm

1/2
23-198
145 mm

for soft wire
up to diam. 2,0 mm
For hard wire
up to diam. 1,5 mm

1/2
23-199
220 mm

for soft wire
up to diam. 3,5 mm
For hard wire
up to diam. 2,5 mm

Wire Cutting Pliers



1/2

Cutter for cutting off
KIRSCHNER wires,
Tibia head screws,
bolts, pins, up to 3 mm diam.

23-200
320 mm

for soft wire up to diam. 3,0 mm
For hard wire up to diam 3,0 mm



Durotip

23-201
Cutter for cutting off
KIRSCHNER wires,
Tibia head screws,
bolts, pins, up to 6 mm diam.
470 mm

Finger Nail Instruments

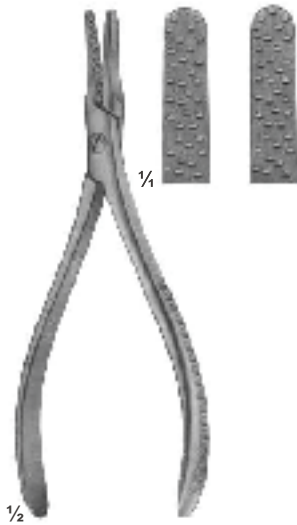

23-202
Nail extracting
forceps
135 mm



23-203
Nail extracting
forceps
145 mm

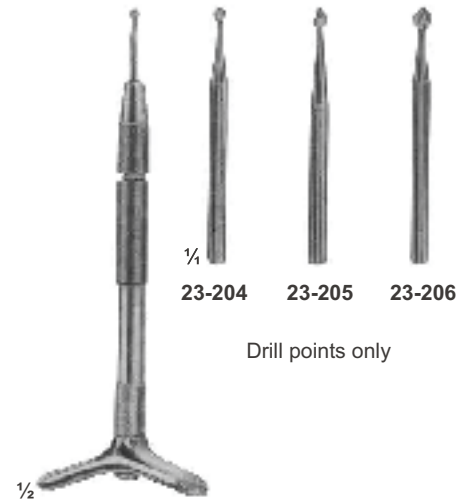

23-204 - 206
Finger nail drill
with 3 points

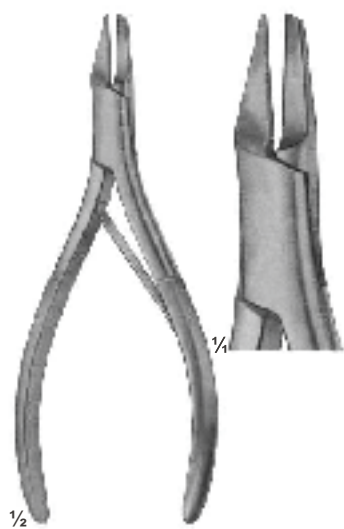

23-207
Nail splitting
forceps
135 mm

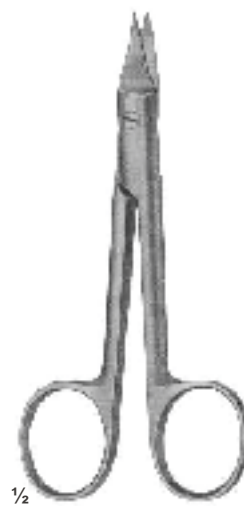

23-208
SYSTRUNK
Scissors, for splitting
finger nails
130 mm

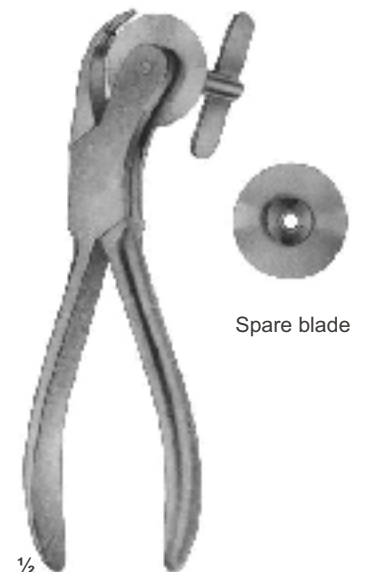

23-209
Finger ring saw
150 mm

Plaster Instruments



with ebony handle

24-101
HOPKINS
200 mm



1/2

24-102
ESMARCH
180 mm



1/2

24-103
ENGEL
160 mm

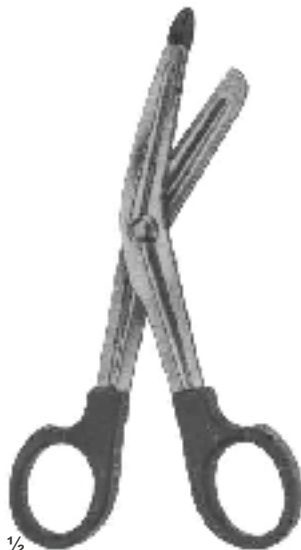

1/2

24-104 - 112

- | | | | |
|---------------|-------|---------------|-------------|
| 24-104 | black | 24-108 | yellow |
| 24-105 | red | 24-109 | white |
| 24-106 | blue | 24-110 | orange |
| 24-107 | green | 24-111 | lavender |
| | | 24-112 | bright pink |



1/2

24-113 - 121

- | | | | |
|---------------|-------|---------------|-------------|
| 24-113 | black | 24-117 | yellow |
| 24-114 | red | 24-118 | white |
| 24-115 | blue | 24-119 | orange |
| 24-116 | green | 24-120 | lavender |
| | | 24-121 | bright pink |

Plaster Scissors

For small plaster dressings

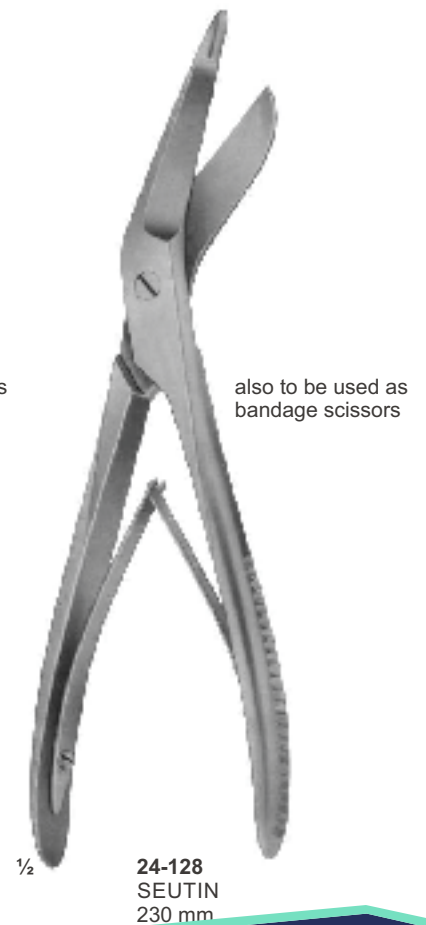
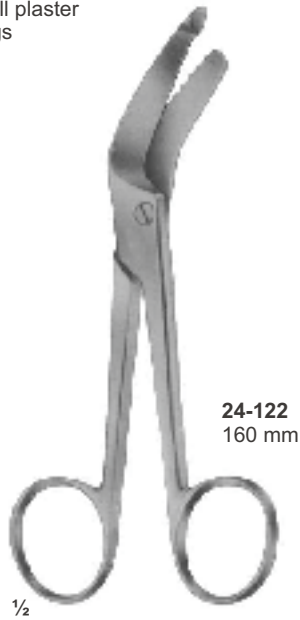

Plaster Shears



24-129
STILLE-AESULAP
260 mm



24-130
STILLE-AESULAP
360 mm

STILLE Plaster Shears

Blade with reinforced back



24-131
STILLE
230 mm

24-132
Spare blade



24-133
STILLE
370 mm

24-134
Spare blade



24-135
STILLE
240 mm

24-136
Spare blade

Plaster Spreader, Plaster Breakers



24-137
HENING
270 mm



24-138
MOD.USA
230 mm



24-139
290 mm



with removable jaws



24-140 - 141
WOLFF
24-140 180 mm
24-141 240 mm

Vacuum Currettes for Aspiration Lipectomy, Suction Instruments

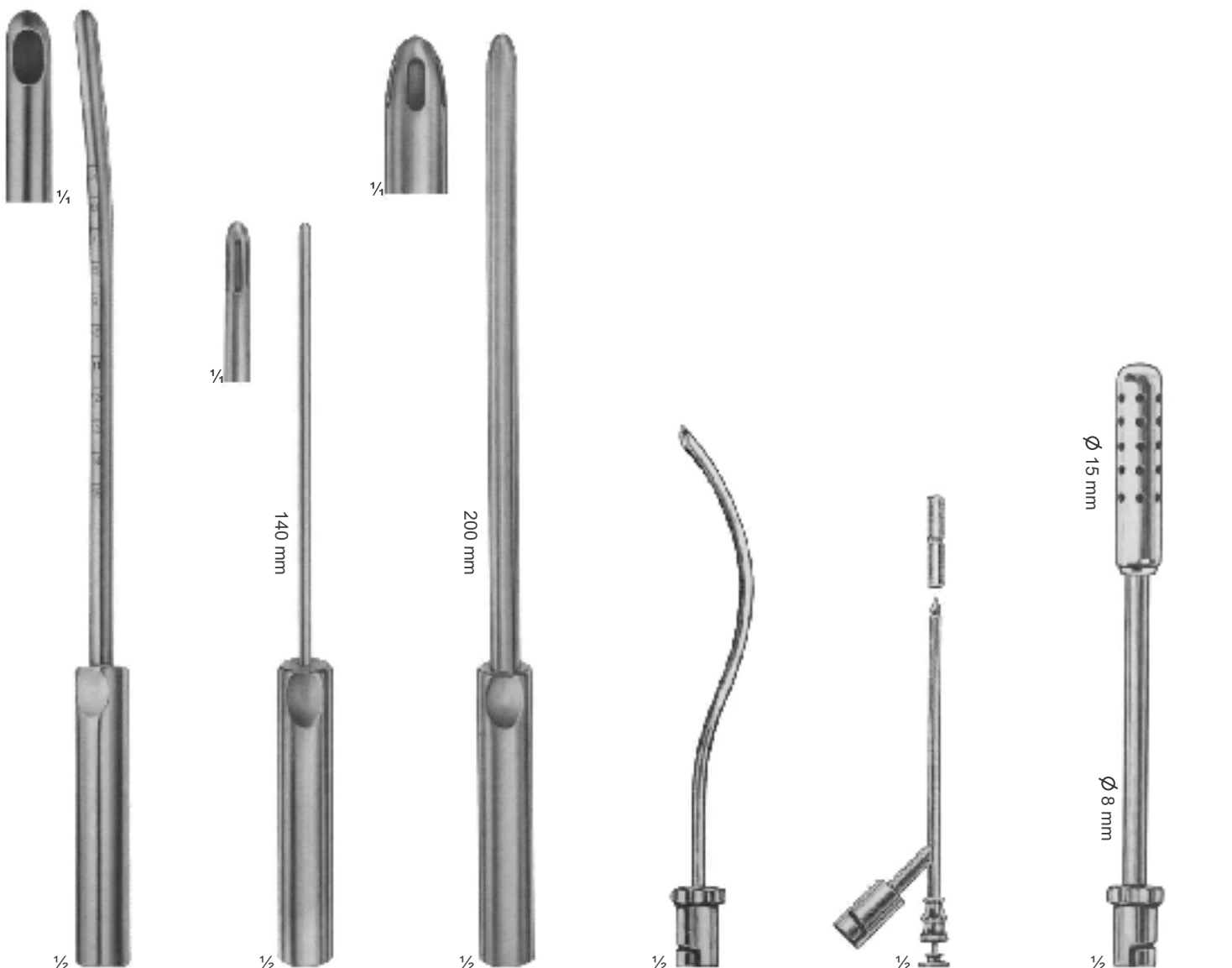

25-101 - 106
BIEMER
25-101 \varnothing 4 mm
25-102 \varnothing 6 mm
25-103 \varnothing 8 mm
25-104 \varnothing 10 mm
25-105 \varnothing 12 mm
25-106 \varnothing 14 mm
Currettes for aspiration
lipectomy, graduated,
slightly curved

25-107 - 108
BIEMER
25-107 \varnothing 4 mm
25-108 \varnothing 6 mm
Currettes for aspiration
lipectomy, with three
apertures, slightly curved
malleable

25-109 - 111
BIEMER
25-109 \varnothing 8 mm
25-110 \varnothing 10 mm
25-111 \varnothing 12 mm
Currettes for aspiration
lipectomy, with three
apertures, slightly curved
malleable

25-112
For aspirating
fluid from the excretory
ducts of large glands
and for keeping the
operating area clear
170 mm

25-113
Trocar
For puncturing
150 mm

25-114
For clearing
large quantities
of fluid
190 mm

Suction Instruments



25-115
Trocar
For puncturing
170 mm



25-116
Hollow needle,
sharp
150 mm



25-117
double curved
For general
surgery
230 mm



25-118
For tonsillectomy,
oral and laryngeal
operations
190 mm



25-119
For tonsillectomy,
oral and laryngeal
operations
220 mm

Suction Instruments

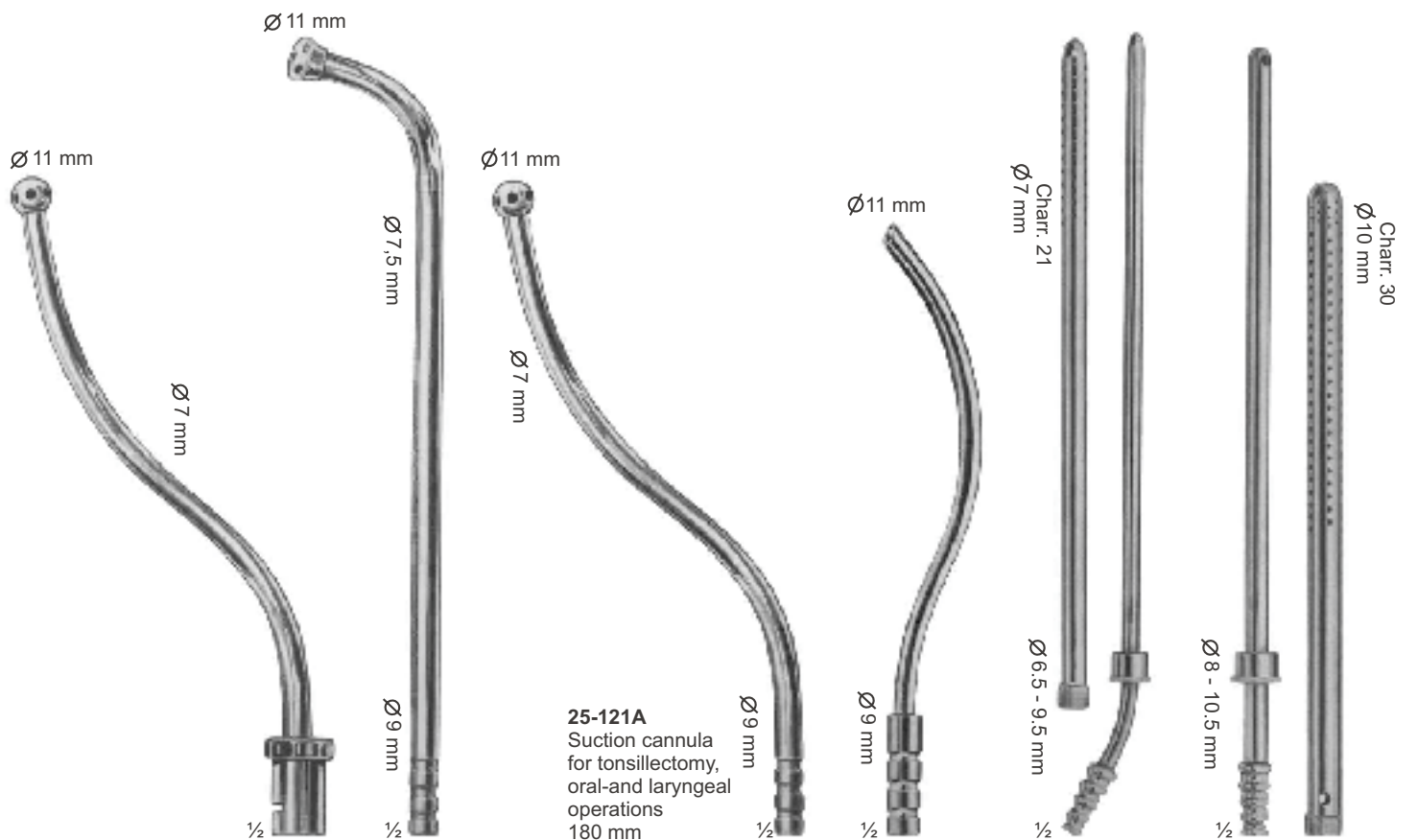

25-120
For tonsillectomy,
oral-and laryngeal
operations
180 mm

25-121
Suction cannula
for tonsillectomy,
oral-and laryngeal
operations
220 mm

25-121A
Suction cannula
for tonsillectomy,
oral-and laryngeal
operations
180 mm

25-122
S-shaped blunt cannula
for aspirating fluid from
the excretory ducts of
large glands and for
keeping the operations
area clear
170 mm

25-123
POOL
Suction cannula,
with outer tube
to be screwed of
225 mm

25-124
POOL
Suction cannula,
with outer tube
to be screwed of
225 mm

Suction Instruments

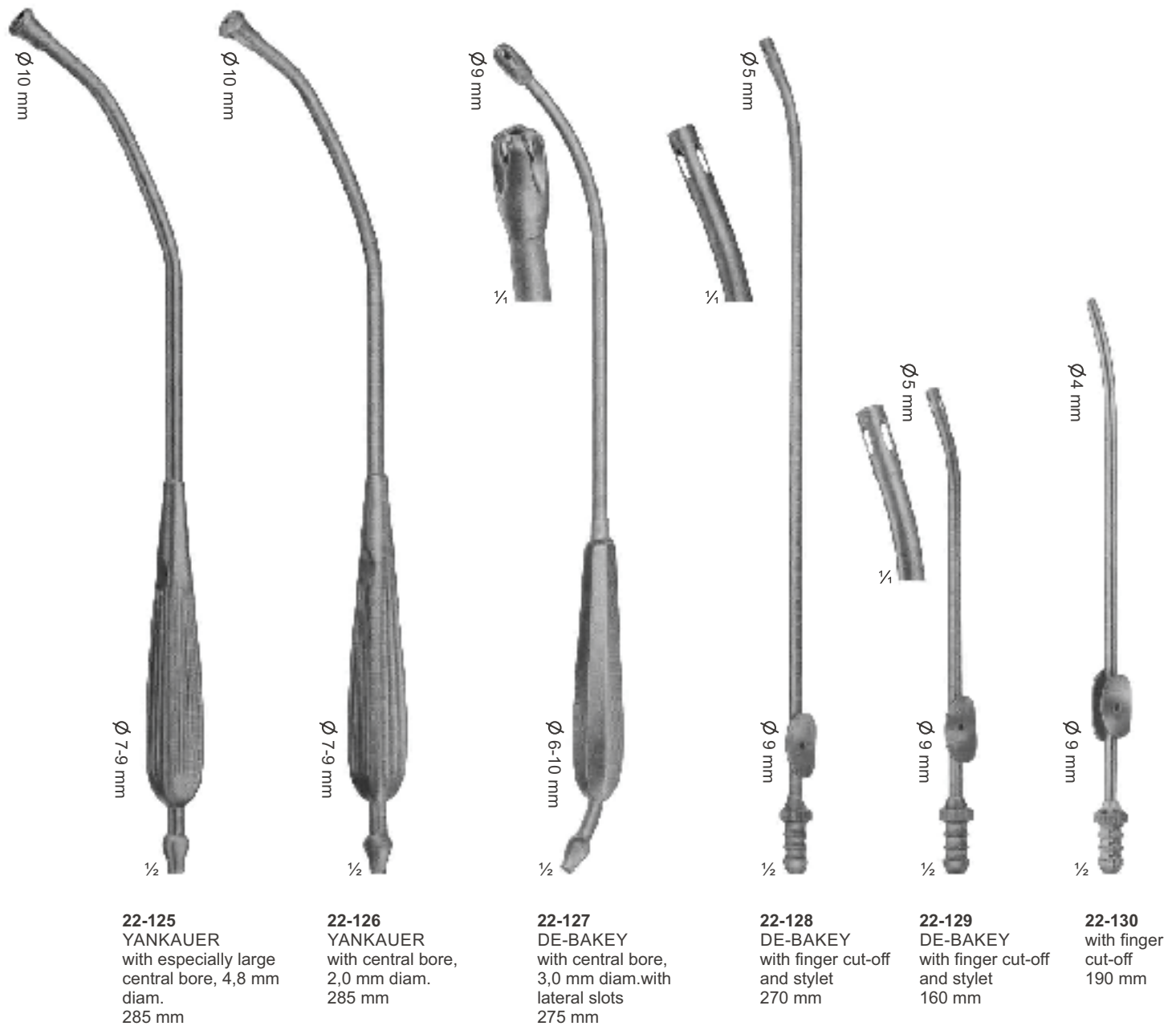

Suction Instruments

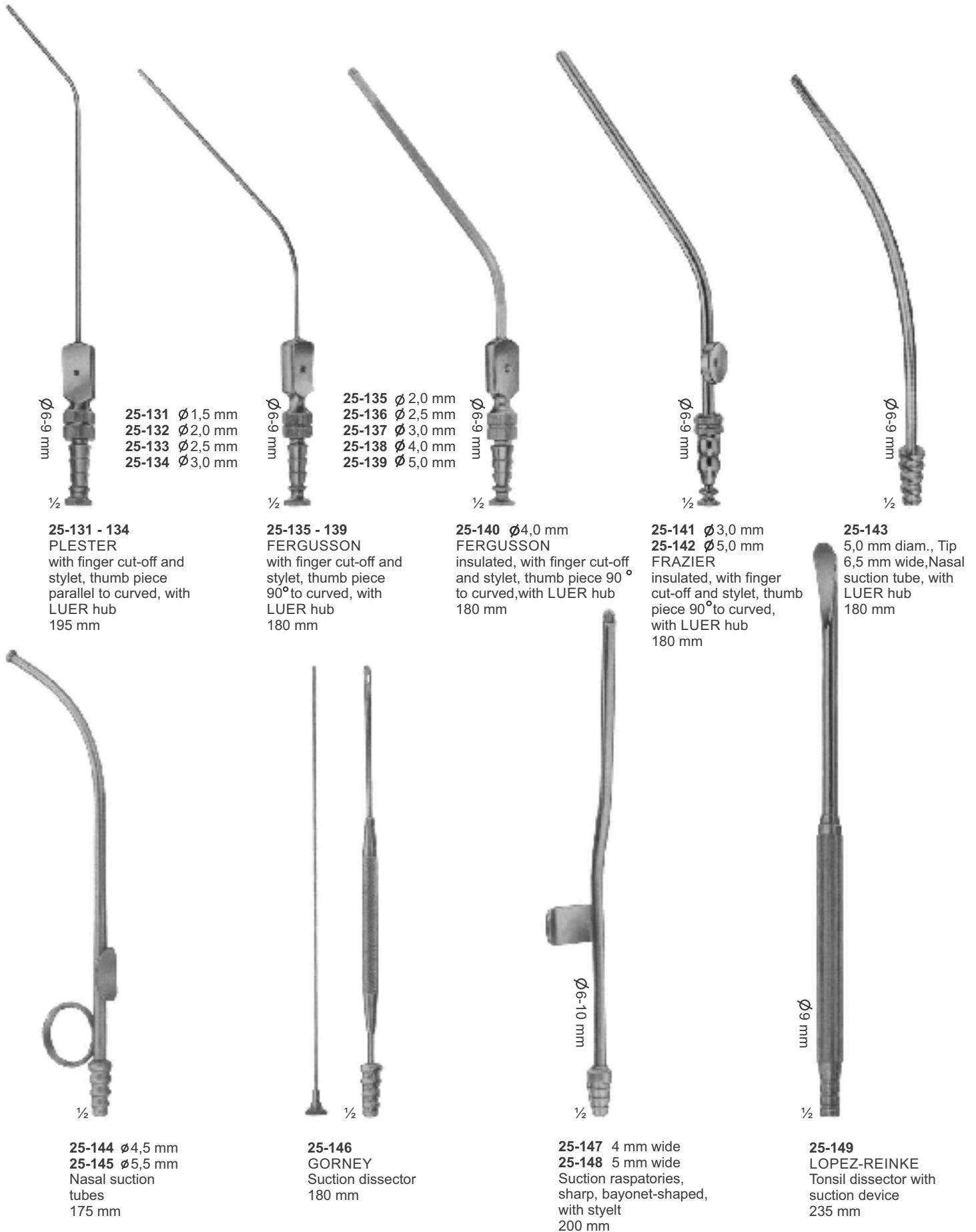

Suction Instruments

25-150
WULLSTEIN
Suction tube, conical, silver, oliver
with LUER hub
160 mm



25-151 1,5 mm
25-152 2,0 mm
WULLSTEIN
Suction tube, cylindrical, silver, with
stylet with LUER hub
160 mm



Usable length

| YASARGIL usable length diam. | | YASARGIL usable length diam. | |
|------------------------------|---------------|------------------------------|---------------|
| 25-153 | 130 mm 1,5 mm | 25-161 | 130 mm 2,5 mm |
| 25-154 | 150 mm 1,5 mm | 25-162 | 150 mm 2,5 mm |
| 25-155 | 180 mm 1,5 mm | 25-163 | 180 mm 2,5 mm |
| 25-156 | 220 mm 1,5 mm | 25-164 | 220 mm 2,5 mm |
| 25-157 | 130 mm 2,0 mm | 25-165 | 130 mm 3,5 mm |
| 25-158 | 150 mm 2,0 mm | 25-166 | 150 mm 3,5 mm |
| 25-159 | 180 mm 2,0 mm | 25-167 | 180 mm 3,5 mm |
| 25-160 | 220 mm 2,0 mm | 25-168 | 220 mm 3,5 mm |
| | | 25-169 | 180 mm 4,5 mm |

Ø6,5-9 mm
with LUER hub

25-170 - 172
LANDOLT
150 MM
diam Ø3 mm

25-170 8 mm / curved
25-171 11mm / curved
25-172 15mm / curved

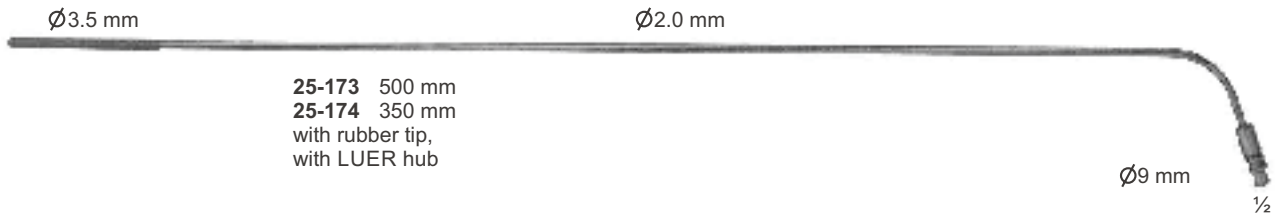
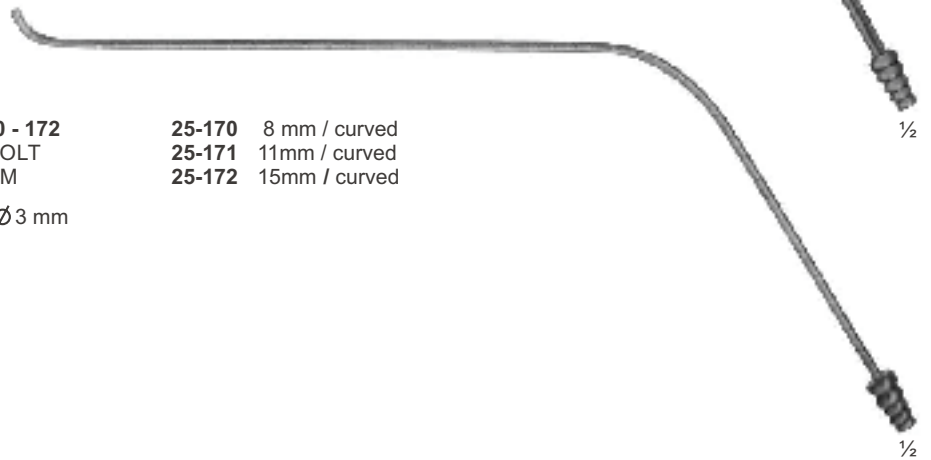

25-173 500 mm
25-174 350 mm
with rubber tip,
with LUER hub

25-175 2,0 mm diam
25-176 2,5 mm diam
25-177 3,0 mm diam
with finger cut-off,
thumb piece 90° to
curved, with LUER hub
250 mm



Combined Suction and Irrigation Cannulae

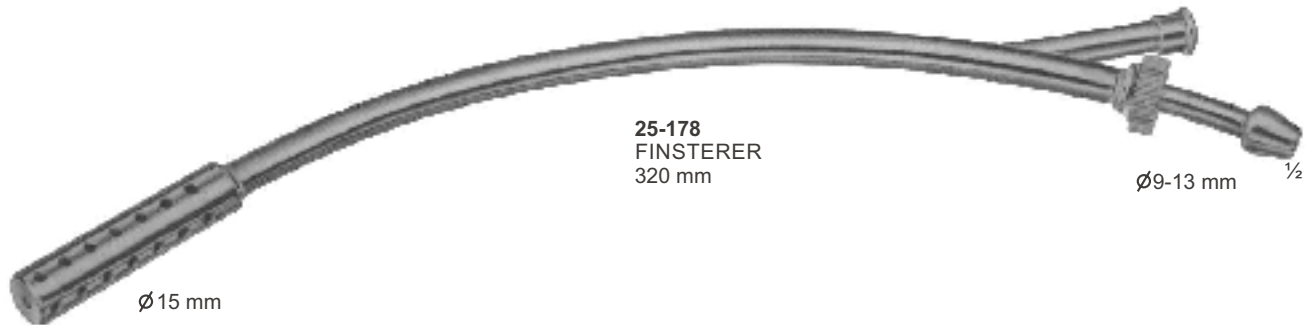

25-179
YASARGIL
LURE-LOCK cone
200 mm

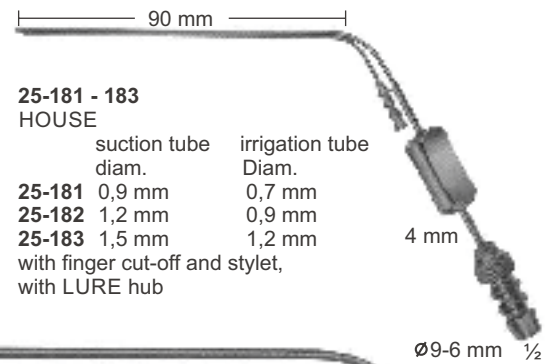
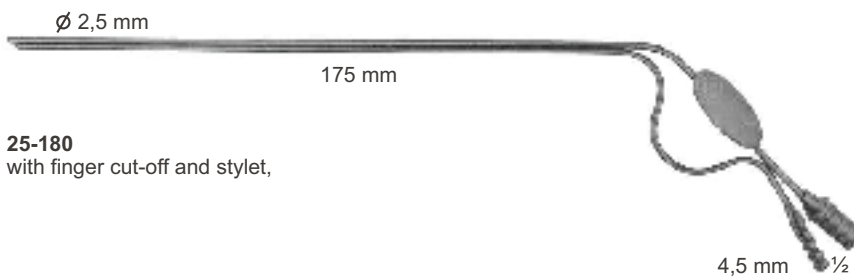

25-181
with finger cut-off and stylet,
with LURE hub

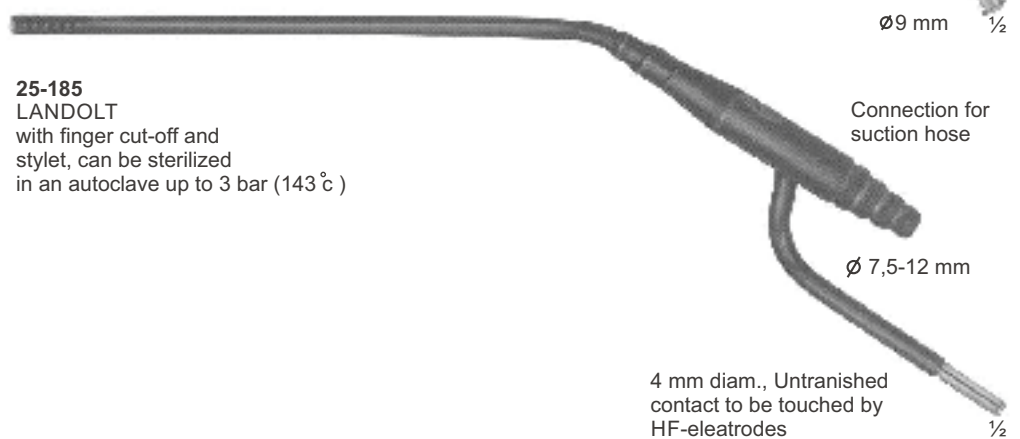
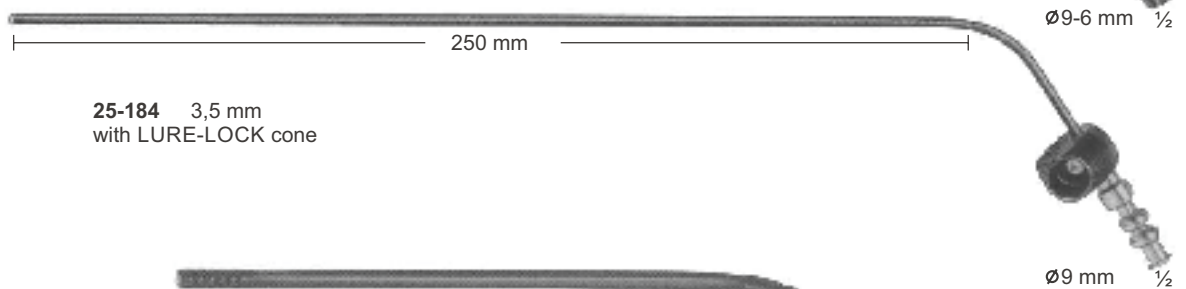

Scissors with Tungsten Carbide Inserts



26-101
Standard

14,5cm
16,5cm
18,5cm



26-102
Standard

14,5cm
16,5cm
18,5cm



26-103
Standard

14,5cm
16,5cm
18,5cm



26-104
Standard

14,5cm
16,5cm
18,5cm



26-105
Standard

14,5cm
16,5cm
18,5cm



26-106
Standard

14,5cm
16,5cm
18,5cm

Scissors with Tungsten Carbide Inserts

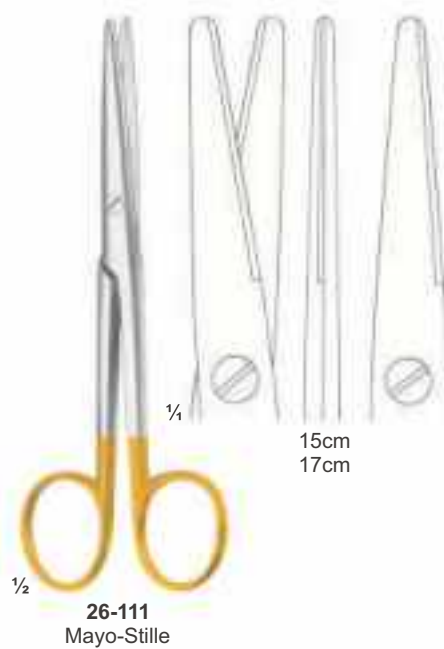

Scissors with Tungsten Carbide Inserts

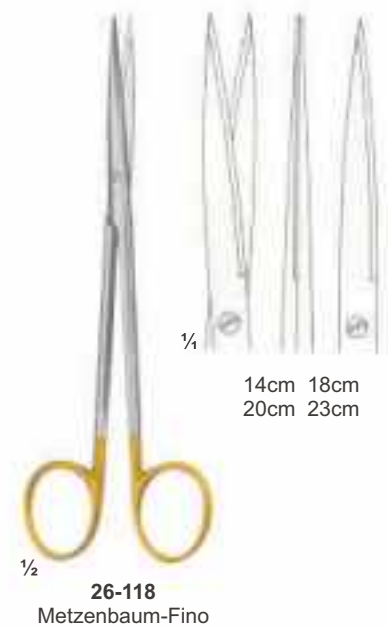

Scissors with Tungsten Carbide Inserts

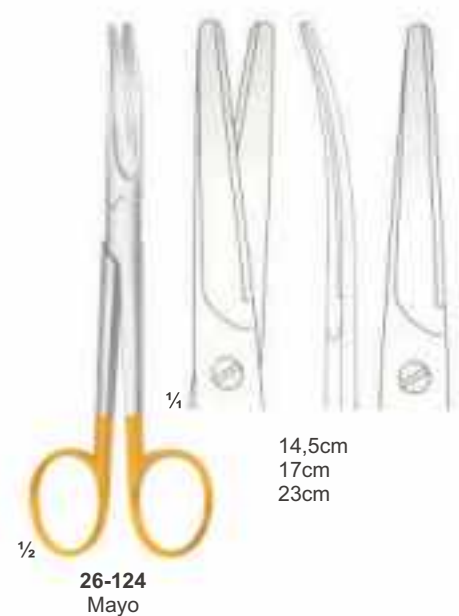
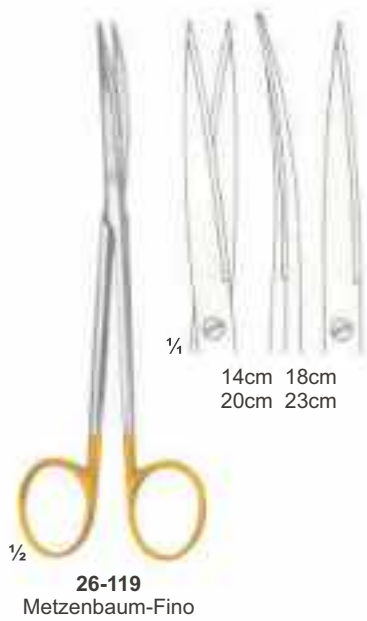

Scissors with Tungsten Carbide Inserts



Scissors with Tungsten Carbide Inserts

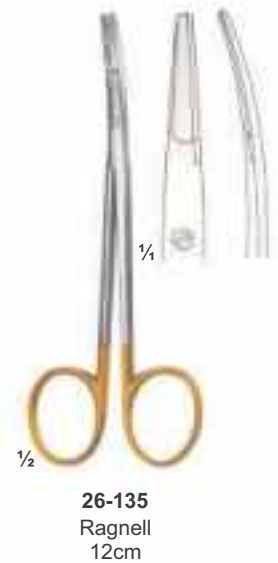

Scissors & Dissecting Forceps with Tungsten Carbide Inserts

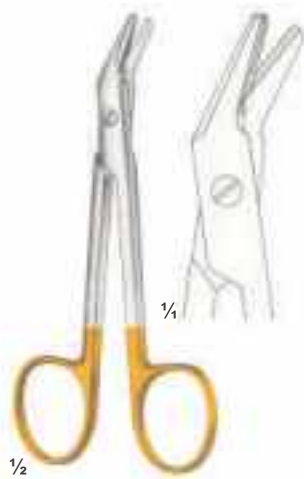

26-136
Universal
12cm



26-137
Ligature Scissors
1 Black & 1 Goldplated ring



26-138
Adson



26-139
Cushing
17,5cm



26-140
Cushing
18cm



26-141
Cushing-Taylor
18cm



26-142
Dissecting Forceps
15cm



26-143
Semken
15cm

Dissecting Forceps and Needle holders with Tungsten Carbide Inserts

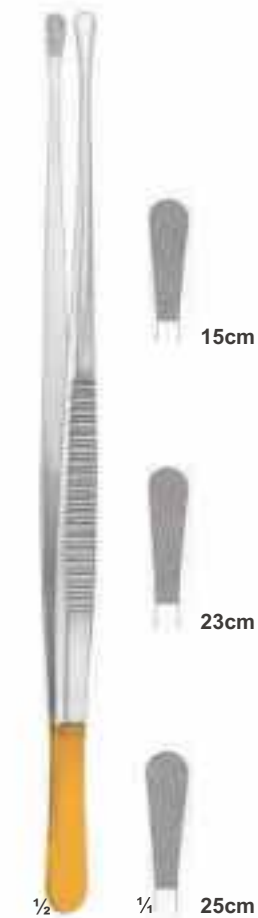

26-144
Wangenstein

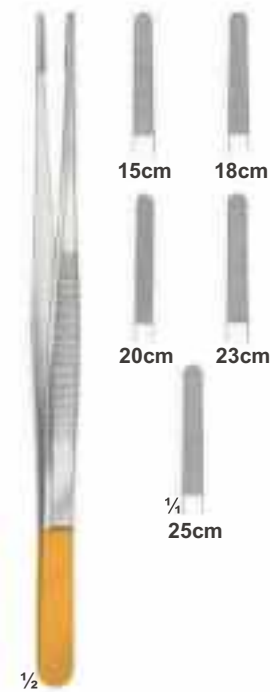

26-145
Potts-Smith

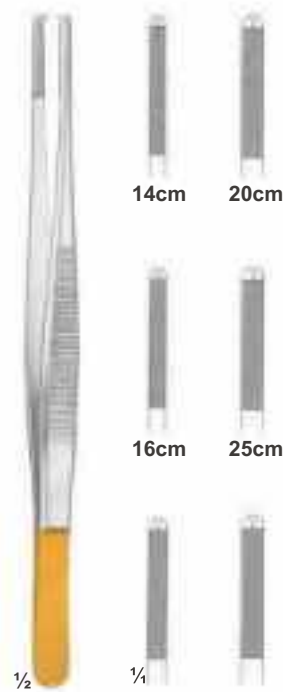

26-146
Oehler



26-147
Potts-Smith
22cm



26-148
Hepp-Scheidle
18cm



26-149
Castroviejo
14cm



26-150
Castroviejo
14cm



26-151
Arruga
16cm

Needle holders with Tungsten Carbide Inserts



26-152
Arruga
16cm



26-153
Castroviejo
13cm



26-154
Hegar
20cm 24cm

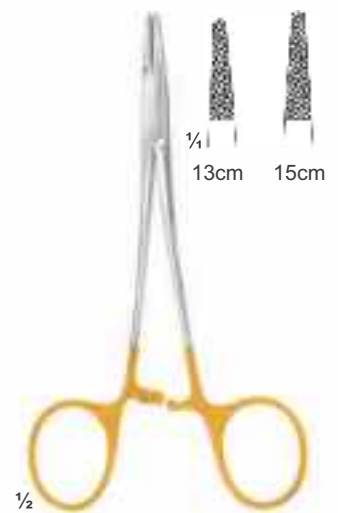

26-155
Halsey
13cm 15cm

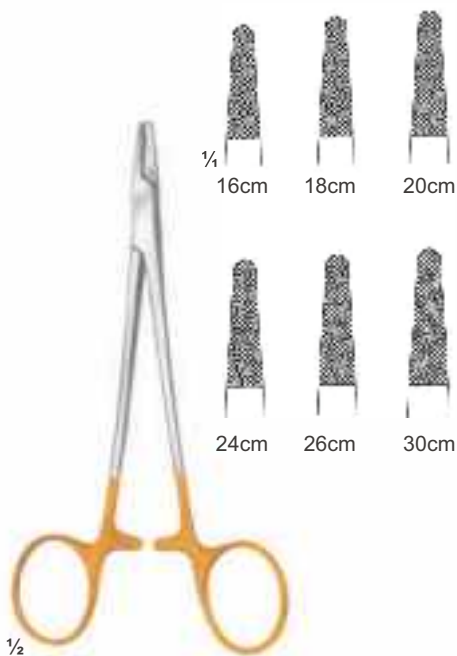

26-156
Mayo-Hegar
16cm 18cm 20cm
24cm 26cm 30cm

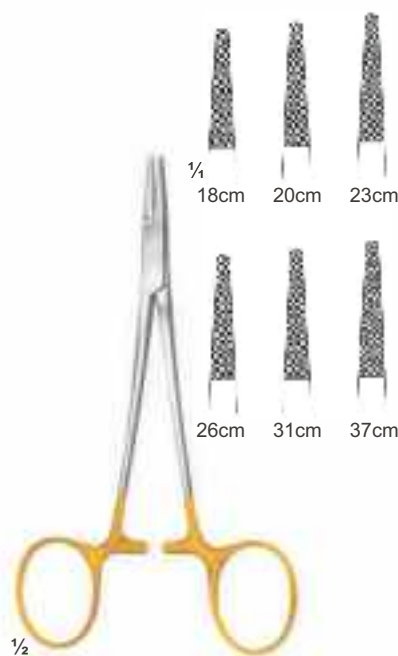

26-157
De-Bakey
18cm 20cm 23cm
26cm 31cm 37cm

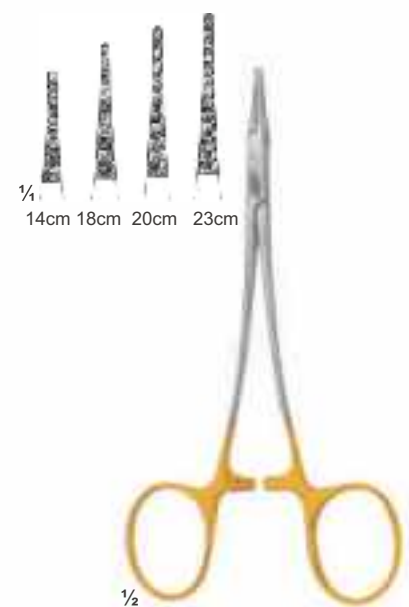

26-158
Hegar-Vascular
14cm 18cm
20cm 23cm

Needle holders with Tungsten Carbide Inserts



$\frac{1}{2}$
26-159
Bozemann-Wertheim
20cm 24cm 26cm



$\frac{1}{2}$
26-160
Stratte
22cm 23cm

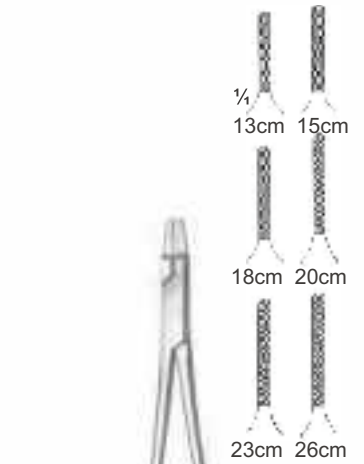

$\frac{1}{2}$
26-161
Ryder
13cm 15cm 18cm
20cm 23cm 26cm

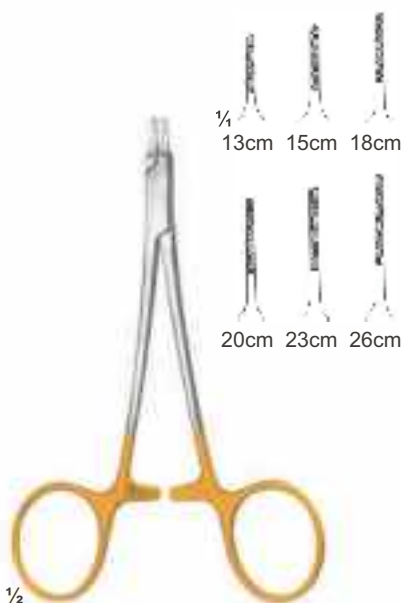

$\frac{1}{2}$
26-162
Ryder-Vascular
13cm 15cm 18cm
20cm 23cm 26cm



$\frac{1}{2}$
26-163
Martin
15cm 17cm 20cm

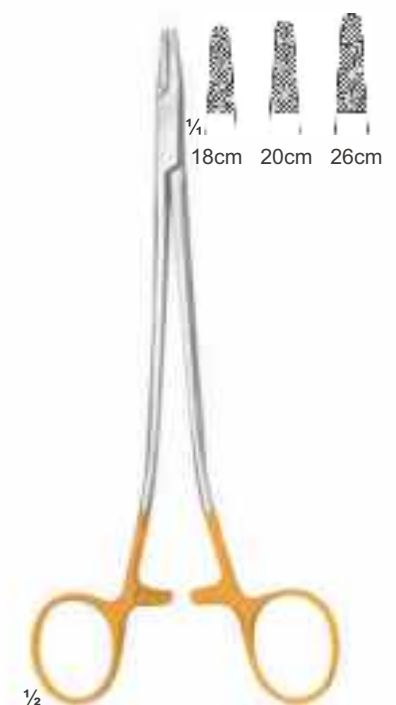

$\frac{1}{2}$
26-164
Sarot
18cm 20cm 26cm

Needle holders with Tungsten Carbide Inserts

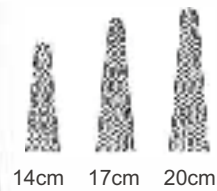
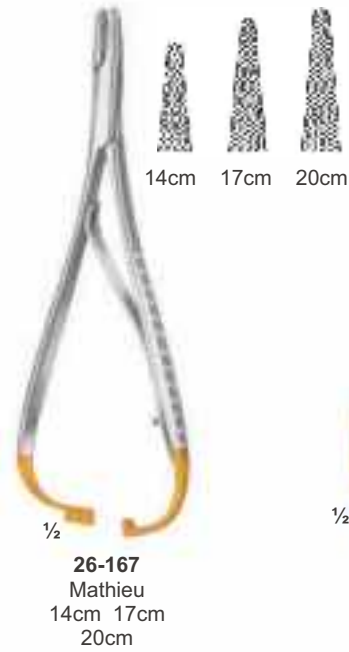

Needle holders with Tungsten Carbide Inserts

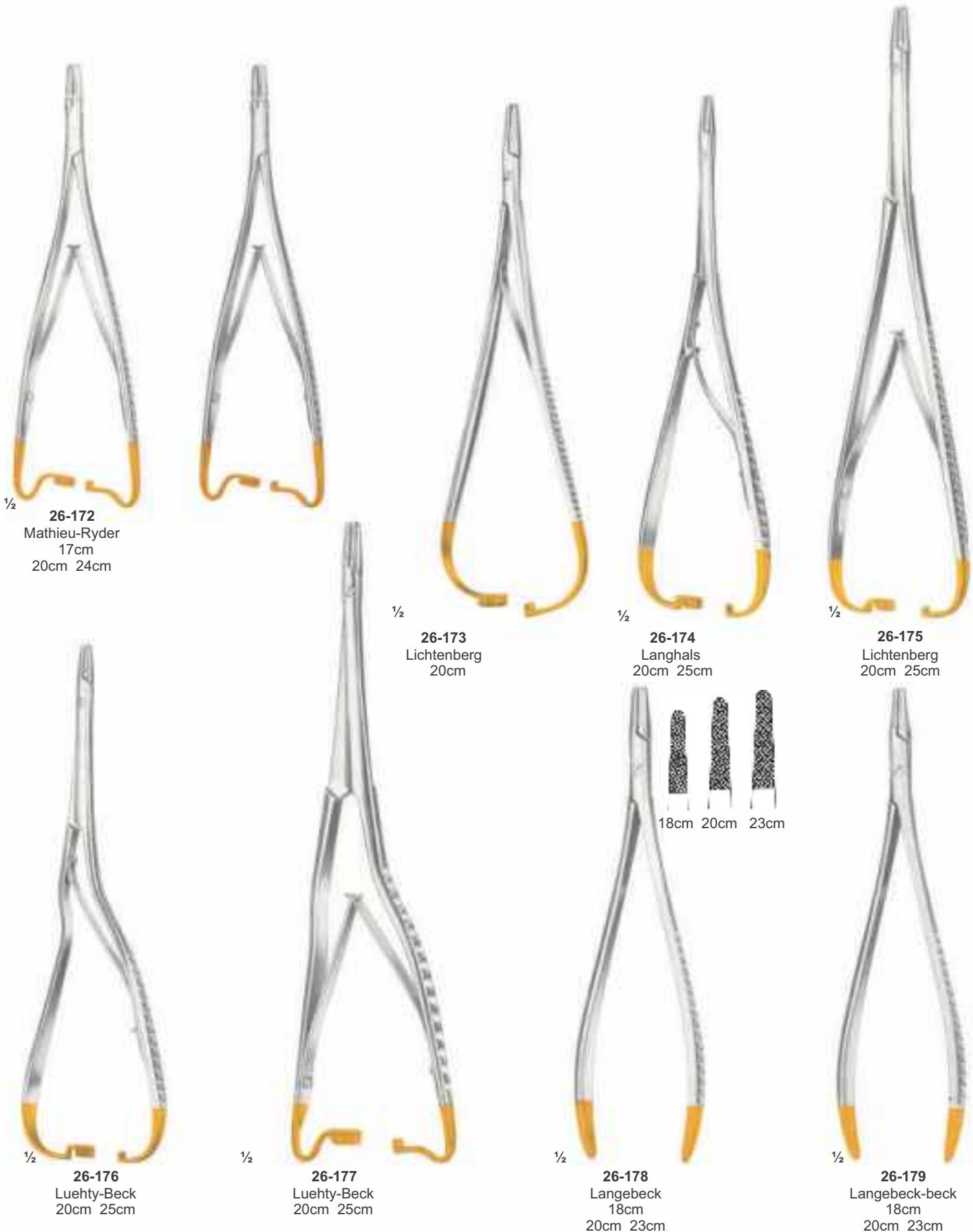

Hospital Wares



27-101 - 115
Schimmelbusch

Ø x H
sizes in mm

| | |
|---------------|-----------|
| 27-101 | 80 x 80 |
| 27-102 | 105 x 120 |
| 27-103 | 140 x 140 |
| 27-104 | 160 x 120 |
| 27-105 | 160 x 150 |
| 27-106 | 190 x 150 |
| 27-107 | 190 x 190 |
| 27-108 | 240 x 160 |
| 27-109 | 240 x 240 |
| 27-110 | 290 x 160 |
| 27-111 | 290 x 240 |
| 27-112 | 340 x 160 |
| 27-113 | 340 x 340 |
| 27-114 | 390 x 190 |
| 27-115 | 390 x 290 |



27-116
Box
120 x 65 x 13mm
(without Bulldog clamps,
without silicone tape)



27-117
Box with support
120 x 65 x 13 mm
(ohne Bulldogklemmen)

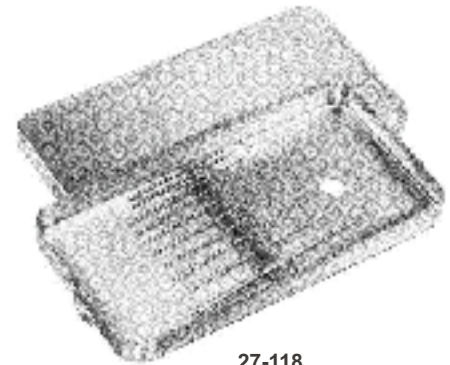

27-118
Box with support for
needle electrodes,
without instruments



27-119 - 121
50 x 25 x 4,5 mm
27-120
65 x 42 x 8 mm
27-121
75 x 25 x 4,5 mm

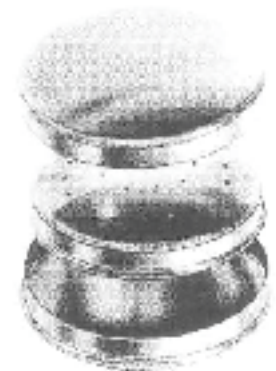

27-122
Ø 65mm x 15mm

Hospital Wares

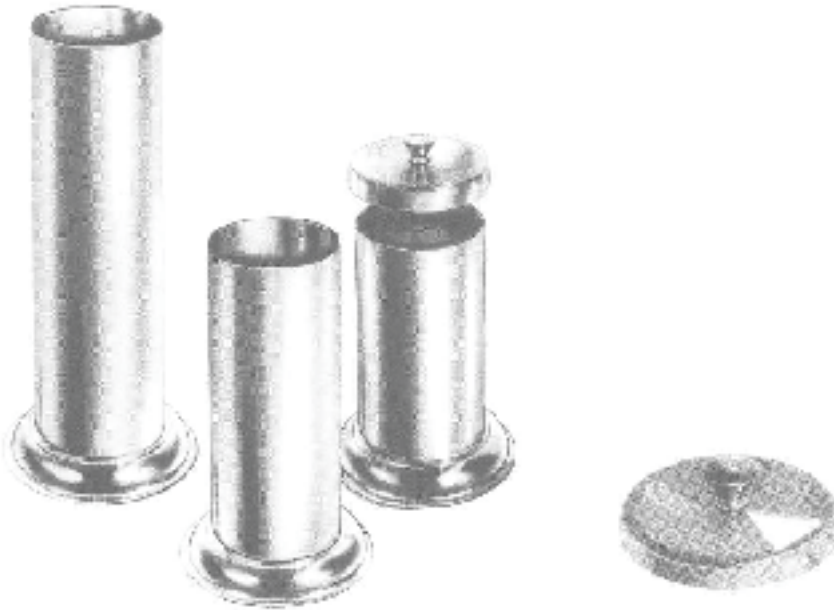

27-123 - 131

| | Ø x H |
|--------|--------------|
| 27-123 | 30 x 90 mm |
| 27-124 | 50 x 100 mm |
| 27-125 | 50 x 130 mm |
| 27-126 | 50 x 175 mm |
| 27-127 | 75 x 100 mm |
| 27-128 | 75 x 130 mm |
| 27-129 | 75 x 175 mm |
| 27-130 | 100 x 175 mm |
| 27-131 | 100 x 200 mm |



27-132 - 139

| | |
|--------|-------------------|
| 27-132 | 165 x 85 x 35 mm |
| 27-133 | 200 x 100 x 35 mm |
| 27-134 | 200 x 100 x 50 mm |
| 27-135 | 230 x 130 x 50 mm |
| 27-136 | 260 x 150 x 50 mm |
| 27-137 | 270 x 235 x 50 mm |
| 27-138 | 300 x 200 x 50 mm |
| 27-139 | 325 x 275 x 50 mm |

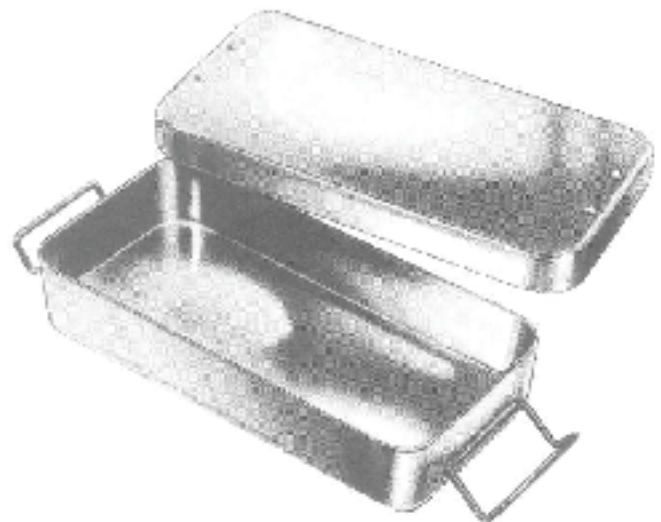

27-140
205 x 105 x 35 mm

Round Metal Boxes and Medicine Cups

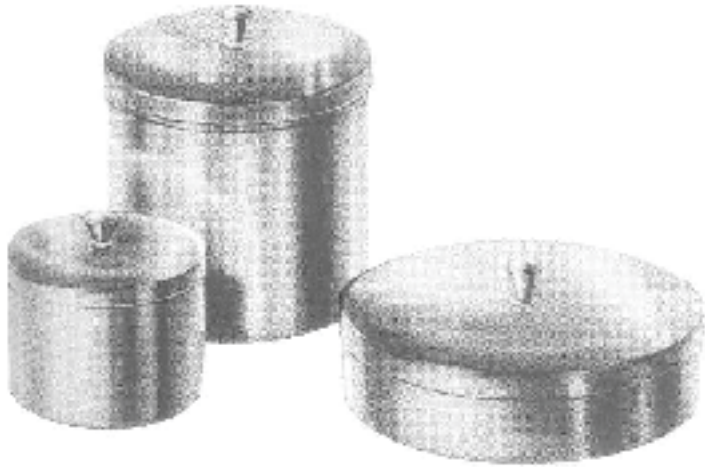

27-143 - 148

| | Ø x H |
|---------|--------------|
| 27-143 | 75 x 60 mm |
| 27-144 | 75 x 75 mm |
| 27-145 | 100 x 60 mm |
| 27-146 | 100 x 100 mm |
| 27-146A | 125 x 80 mm |
| 27-147 | 125 x 125 mm |
| 27-148 | 150 x 150 mm |



27-149
25 cc

27-150
50 cc



27-151
20 cc
Medicine Spoon



27-152
Ø75 x 12 mm
Tablet Tray



27-153
Ø90 x 90 mm
Metal Cup



27-154
Ø75 x 80 mm
Sputum Cup



Kidney Dish



27-155 - 157

| | |
|--------|-------------------|
| 27-155 | 170 x 100 x 35 mm |
| 27-156 | 250 x 140 x 40 mm |
| 27-157 | 275 x 150 x 45 mm |

Forceps Jars

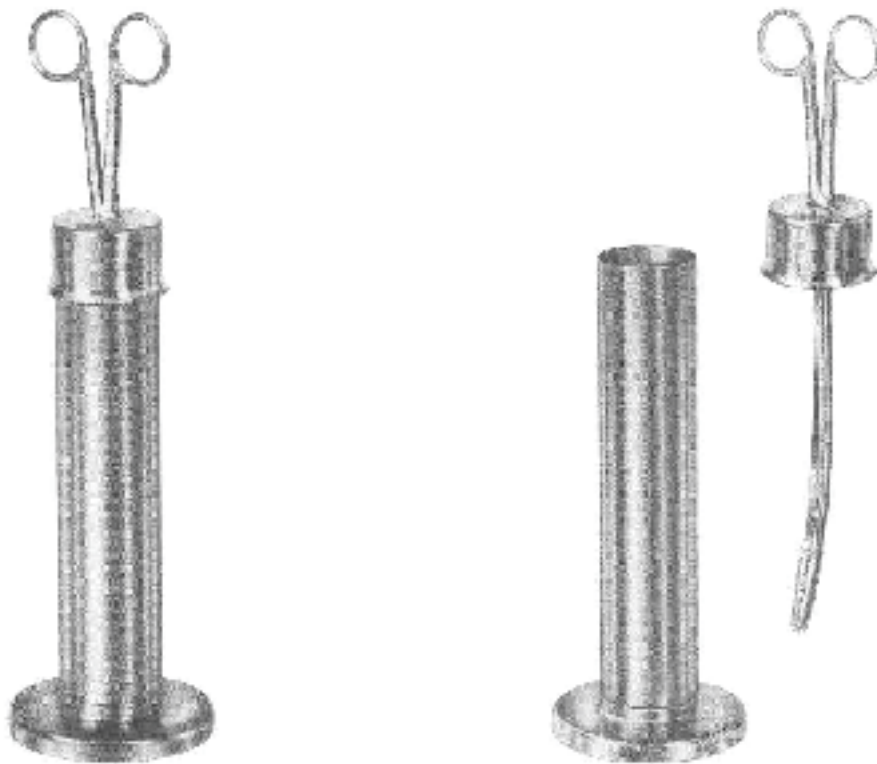

27-141 - 142

- | | |
|---------------|---|
| 27-141 | Martin Sterilizing Forceps consisting of: 1 Sterilizing Forceps, curved, 25 cm, without ratchet, with lid for jar 1 jar with bottom plate (anti-tilt) |
| 27-142 | ditto, with 32 cm long Sterilizing Forceps |

Hospital Wares



27-158 - 165

| | Ø x H | |
|--------|-------------|-------|
| 27-158 | 40 x 19 mm | 0.05L |
| 27-159 | 61 x 30 mm | 0.07L |
| 27-160 | 80 x 40 mm | 0.14L |
| 27-161 | 116 x 50 mm | 0.35L |
| 27-162 | 128 x 55 mm | 0.45L |
| 27-163 | 147 x 65 mm | 0.70L |
| 27-164 | 167 x 75 mm | 1.10L |
| 27-165 | 187 x 85 mm | 1.60L |



27-166 - 170

| | | |
|--------|-------------|-------|
| 27-166 | 116 x 35 mm | 0.30L |
| 27-167 | 128 x 38 mm | 0.40L |
| 27-168 | 147 x 40 mm | 0.50L |
| 27-169 | 157 x 45 mm | 0.75L |
| 27-170 | 187 x 45 mm | 1.00L |



27-171
Ø 110 x 28 mm 0.15L



27-172
100 cc 0.1L



27-173 - 176
27-173 0,25L
27-174 0,50L
27-175 1,00L
27-176 2,00L



27-177
235 x 190 x 40 mm



27-178
Ø220 x 70 mm

Hospital Wares



27-179
Ø 50 x 100 mm
Powder Pot



27-180
Ø 50 x 75 mm
Methot With Lid



27-181
Ø 50 x 75 mm
Methot Without Lid

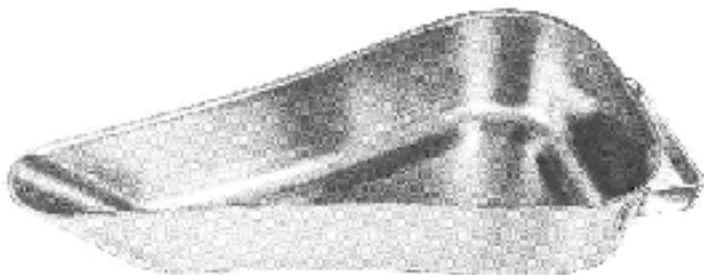

27-182

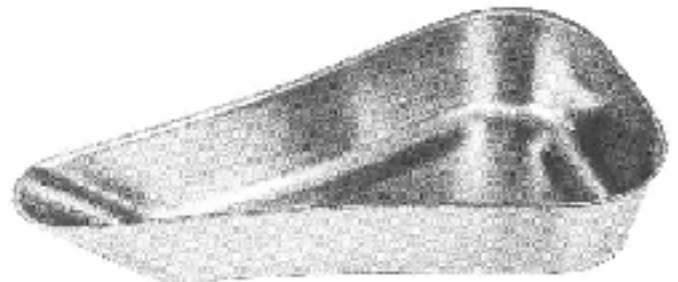

27-183

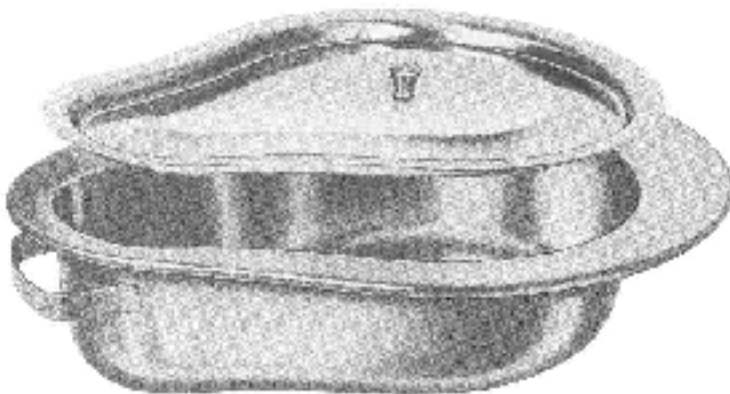

27-184

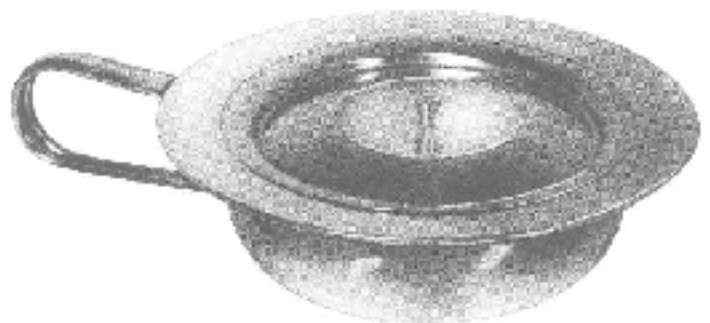

27-185 - 186

27-185 Ø 235 mm
27-186 Ø 310 mm

Needle Cases



27-187
Sauerbruch
210 x 125 x 17 mm



27-188
Sauerbruch
210 x 125 x 17 mm



27-189
150 x 95 x 13 mm

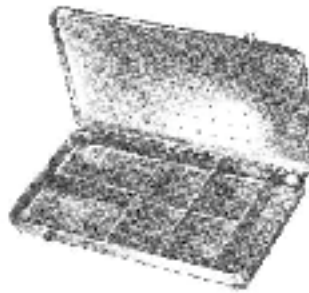

27-190
150 x 95 x 13 mm



27-191
150 x 95 x 13 mm

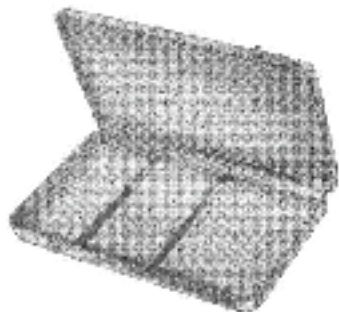

27-192
150 x 95 x 13 mm

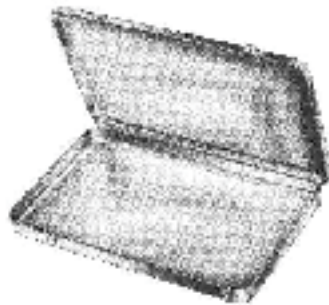

27-193
150 x 95 x 13 mm



27-194
150 x 95 x 13 mm



27-195
150 x 95 x 11 mm

Storing Cases



27-196
Deponette
245 x 135 x 35mm

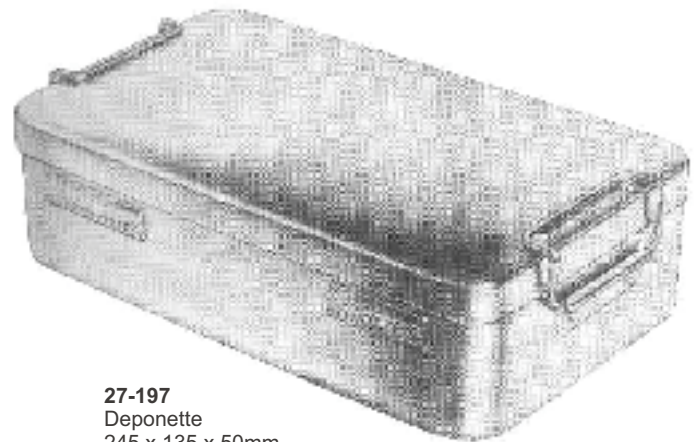

27-197
Deponette
245 x 135 x 50mm

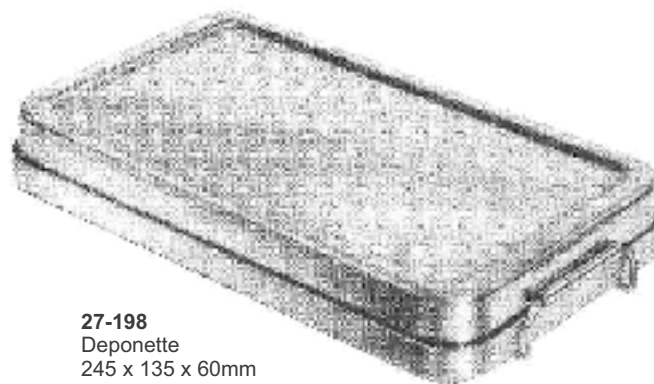

27-198
Deponette
245 x 135 x 60mm

Storing Cases

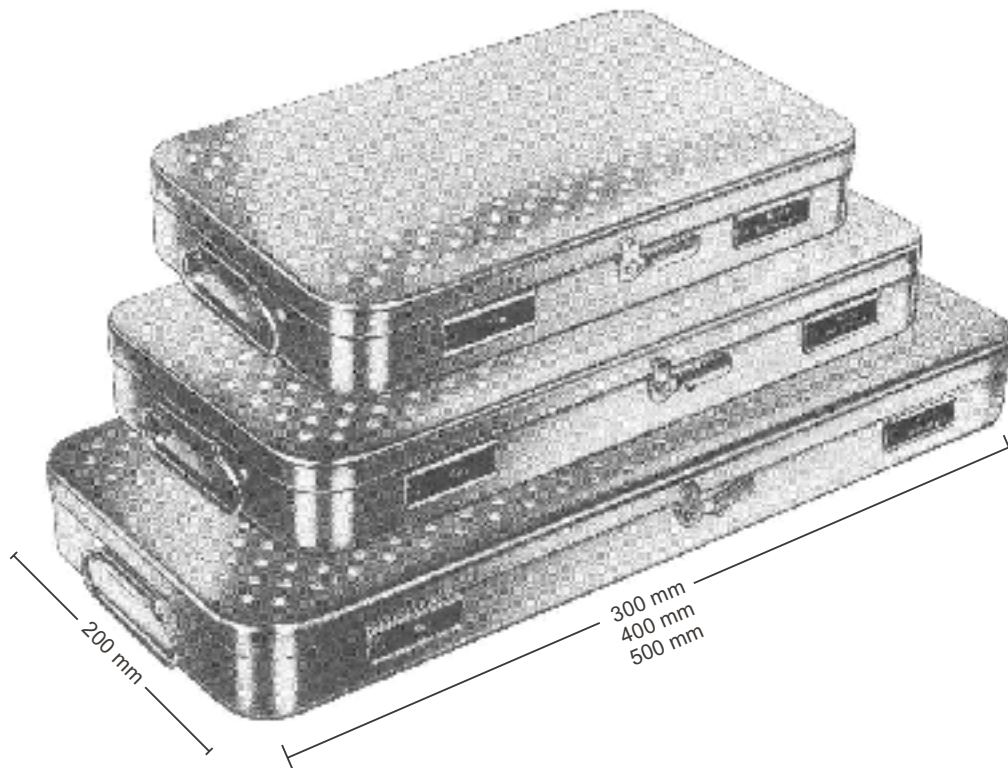

27-199 - 209

| | | |
|--------|----------------|----|
| 27-199 | 230 x 130 x 50 | mm |
| 27-200 | 260 x 150 x 50 | mm |
| 27-201 | 275 x 235 x 50 | mm |
| 27-202 | 300 x 200 x 50 | mm |
| 27-203 | 325 x 275 x 50 | mm |
| 27-204 | 420 x 175 x 50 | mm |
| 27-205 | 230 x 130 x 75 | mm |
| 27-206 | 260 x 150 x 75 | mm |
| 27-207 | 300 x 200 x 75 | mm |
| 27-208 | 325 x 275 x 75 | mm |
| 27-209 | 420 x 175 x 75 | mm |

Sterilizing Baskets / Trays



27-210 - 212

| | | |
|--------|-----------------|----|
| 27-210 | 480 x 250 x 50 | mm |
| 27-211 | 520 x 250 x 75 | mm |
| 27-212 | 520 x 250 x 100 | mm |

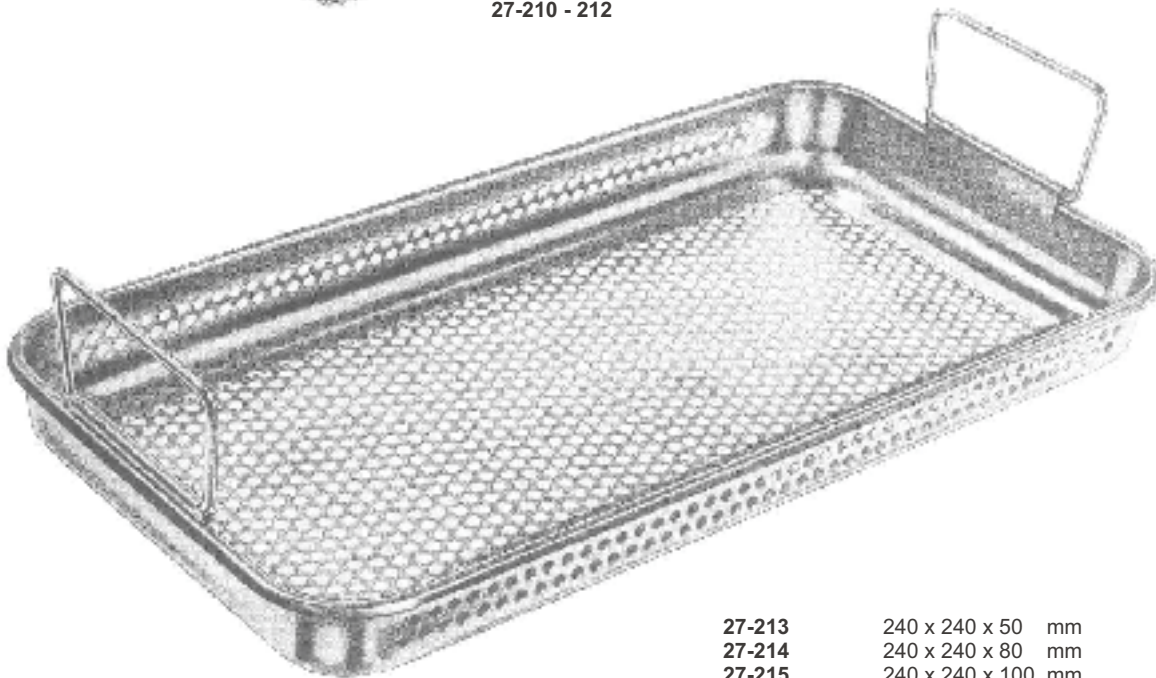

27-213 - 218

| | | |
|--------|-----------------|----|
| 27-213 | 240 x 240 x 50 | mm |
| 27-214 | 240 x 240 x 80 | mm |
| 27-215 | 240 x 240 x 100 | mm |
| 27-216 | 480 x 260 x 50 | mm |
| 27-217 | 520 x 260 x 80 | mm |
| 27-218 | 520 x 260 x 100 | mm |



Manufacturer & Exporter
We believe in quality

DIRECTOR
QASIM BASHIR MEHAR

ADDRESS
Opp Masjid e tayyaba al
qadoos town ,Sialkot

 www.craftecsurgicals.com

 +92 333 8721239

 info@craftecsurgicals.com